

**DCS**

digital combat simulator



# Ka-50 Black Shark

attack helicopter



FLYING LEGENDS™



Eagle Dynamics





## Introduction

Thank you for your purchase of DCS: Black Shark. We at The Fighter Collection and Eagle Dynamics are proud to bring this flight simulation game to you and it marks the first module of our new Digital Combat Simulator line of products. While we have created flight simulation games in the past, the DCS series has some important differences:

1. Rather than focus on several aircraft at a medium level of fidelity, we will release each DCS aircraft module individually and at a very high level of fidelity. Black Shark demonstrates the level of detail that will be the hallmark of the DCS series.
2. The underlying DCS program will be updated over time and each module will be compatible with DCS as it evolves. DCS is a living product.

For the DCS flagship we chose the Ka-50 "Black Shark" for several reasons:

1. It is an interesting and unique attack helicopter due to its single-pilot cockpit, co-axial rotor system, sensor system, and broad mission range.
2. We have a close relationship with Kamov and they were instrumental in providing us the data needed to create an authentic simulation of this aircraft.
3. Our terrain level of detail lends itself to an attack helicopter simulation.
4. We first wish to focus on detailed and realistic close air support operations in DCS.

While it was important to us to create a realistic simulation of the Ka-50 and the associated pilot workload, we also wanted to make the game accessible to the more casual player. As such, we also included a robust set of "game" modes such as casual avionics, flight dynamics, and difficulty settings. We hope this will shallow the learning curve to those not familiar with attack helicopter simulations.

A large focus of DCS: Black Shark, compared to our earlier products, has been on providing good mission gameplay. We did this through several methods:

1. Our Mission Editor includes a powerful scripting system that allows the setting of triggers and resulting events. This allows the mission designer to create missions with more dynamic cause-and-effect situations. Such examples include activating units, displaying messages, playing audio files, and setting linked events. These can be triggered from units entering and exiting specified areas, being damaged or destroyed, or even times. In the hands of a skilled mission designer, interesting and realistic missions can be created.
2. Rather than a linear campaign that requires the player to successfully complete a mission before moving on to the next, we have included a phased-campaign system that allows a front line to move back and forth and allow a non-linear mission progression.
3. Built into the Mission Editor are functions to allow the random appearance of units based on a chance of appearing percentage.

Combined, we feel DCS: Black Shark will provide an immersive and interesting mission environment.

---



Because DCS: Black Shark is solely focused on the Ka-50, we do not expect a gameplay focus of the product to be head-to-head multiplayer. Rather, we believe that DCS: Black Shark will provide interesting cooperative multiplayer given the nature of attack helicopter missions and the ability of a flight of Ka-50s to exchange targeting and navigation data over the data link. With the inclusion of later DCS modules, we do however expect head-to-head multiplayer to be an important part of DCS.

Please note there is a separate DCS manual that discusses the Mission Editor and other menu screens in detail. This manual is focused solely on the operation of the Ka-50 within the DCS environment.

We hope you enjoy your time with DCS: Black Shark and follow the progress of DCS as we add functionality and features to the product over time and add new aircraft modules.

Sincerely,

The DCS: Black Shark Team

DCS: [www.digitalcombatsimulator.com](http://www.digitalcombatsimulator.com)

Forum: <http://forums.eagle.ru>

©2008 The Fighter Collections

©2008 Eagle Dynamics

**All trademarks and registered trademarks** are the property of their respective owners

---



# TABLE OF CONTENTS

<b>1</b>	<b>GENERAL DESIGN .....</b>	<b>1-2</b>
	GENERAL DESIGN AND LAYOUT .....	1-2
	POWER PLANT AND ROTOR SYSTEM .....	1-3
	GENERAL PURPOSE EQUIPMENT .....	1-4
	RADIO EQUIPMENT .....	1-5
	CONTERMEASURES SYSTEMS .....	1-8
	PERFORMANCE CHERACTERISTIICS .....	1-9
<b>2</b>	<b>COCKPIT CONTROLS .....</b>	<b>2-2</b>
	INSTRUMENT PANELS OVERVIEW .....	2-2
	CYCLICK CONTROL STICK.....	2-5
	<i>Release Weapon – Cannon Triggers</i> .....	2-6
	COLLECTIVE CONTROL STICK .....	2-9
	LEFT AND RIGHT FORWARD PANELS.....	2-11
	<i>Left Forward Panel</i> .....	2-11
	<i>Right Forward Panel</i> .....	2-13
	<i>Attitude Director Indicator (ADI)</i> .....	2-14
	<i>Horizontal Situation Indicator (HSI)</i> .....	2-16
	<i>Laser Designator Panel</i> .....	2-19
	<i>Rotor Pitch Indicator</i> .....	2-19
	<i>Barometric Altimeter</i> .....	2-20
	<i>Vertical Velocity Indicator (VVI)</i> .....	2-21
	<i>Rotor RPM Indicator</i> .....	2-21
	<i>Airspeed Indicator</i> .....	2-22
	<i>Accelerometer</i> .....	2-22
	<i>Radar Altimeter</i> .....	2-23
	<i>Clock</i> .....	2-24
	<i>EKRAN System</i> .....	2-25
	<i>Standby Attitude Indicator (SAI)</i> .....	2-33
	<i>Exhaust Gas Temperature Indicator</i> .....	2-35
	<i>Tachometer</i> .....	2-36
	<i>Fuel Quantity Indicator</i> .....	2-36
	<i>Caution Lights Panel</i> .....	2-37
	<i>Left Forward Panel Caution Lamps</i> .....	2-38
	<i>Landing Gear Control Panel</i> .....	2-39
	OVERHEAD PANEL .....	2-40
	<i>PRTz Data Link Control Panel</i> .....	2-45



<i>Laser Warning Receiver (LWR)</i> .....	2-46
<i>UV-26 Countermeasures Control Panel</i> .....	2-47
<i>Magnetic Compass</i> .....	2-49
CENTER PANEL.....	2-52
<i>PUI-800 Weapon Status and Control Panel</i> .....	2-53
<i>Targeting Display Control Panel</i> .....	2-55
<i>Landing Lights and Voice Warning ("Betty") Control Panel</i> .....	2-56
WALL PANEL, FORWARD SECTION.....	2-58
<i>PVI-800 Navigation Control Panel</i> .....	2-59
<i>PVTz-800 Off-Board Targeting Data Link Mode Panel</i> .....	2-66
RIGHT PANEL, MIDDLE SECTION .....	2-67
<i>Autopilot Panel</i> .....	2-68
<i>Automatic Direction Finder (ADF) ARK-22</i> .....	2-69
<i>R-828 Radio Control Panel</i> .....	2-73
<i>Signal Flare Panel</i> .....	2-74
WALL PANEL .....	2-75
<i>Electrical Power Controls</i> .....	2-77
<i>Radio and Data Link Power Control Panel</i> .....	2-78
<i>Fuel Boost Pump Controls</i> .....	2-79
<i>Fire Extinguisher Control Panel</i> .....	2-80
<i>Fuel Shutoff Valve Control</i> .....	2-81
<i>Transmission/Oil Pressure and Temperature Gauges</i> .....	2-82
<i>Onboard Equipment Control Panel</i> .....	2-83
<i>Lighting Control Panel</i> .....	2-84
<i>Electronic Engine Governors</i> .....	2-85
<i>Engine Power Indicator</i> .....	2-86
REAR AUXILIARY PANEL .....	2-88
<i>Ice Defrosting Control Panel</i> .....	2-89
<i>Engines Control Instruments Panel</i> .....	2-89
<i>Automatic Ejection System BIT Panel</i> .....	2-90
<i>Intercom Check Panel</i> .....	2-90
<i>EKRAN and Voice Warning System Control</i> .....	2-91
<i>Hydraulic Temperature and Pressure Indicators</i> .....	2-91
<i>PPK-800 Systems Preparation and Check Panel</i> .....	2-92
<i>LWS, WS and CMS Power and Test Panel</i> .....	2-94
<i>Electrical System Control Panel</i> .....	2-95
<i>Lighting Brightness Control Panel</i> .....	2-96
LEFT PANEL.....	2-97
<i>R-800L1 VHF Radio Control System</i> .....	2-97
<i>Targeting Mode Control Panel</i> .....	2-100
<i>Engine and APU Start-Up Controls</i> .....	2-102



Radio Intercom SPU-9 Panel .....	2-103
Auxiliary Power Unit (APU) Control .....	2-104
<b>3 ADVANCED MOVING MAP SYSTEM AMMS (ABRIS).....</b>	<b>3-2</b>
PURPOSE .....	3-2
ABRIS PANEL CONTROLS.....	3-2
DISPLAY AND INPUT OF INFORMATION IN ABRIS .....	3-3
TURNING ABRIS ON/OFF .....	3-4
DISPLAY OF INFORMATION IN ABRIS .....	3-6
System Bar .....	3-6
OPERATING MODES.....	3-8
MENU Page .....	3-9
NAV Page.....	3-11
ARC Page .....	3-13
HSI Page.....	3-15
MENU OPERATING MODE .....	3-20
MENU/OPTION Sub-Mode.....	3-21
MENU/CONTROL Sub-mode .....	3-34
Saving Route Plans to ABRIS Database.....	3-37
Saving Map Points and Map Lines to ABRIS Database .....	3-38
MENU/PLAN Sub-mode .....	3-39
MENU/PLAN/SPEED Sub-mode.....	3-54
MENU/PLAN/VNAV Sub-mode .....	3-58
MENU/PLAN/METEO Sub-mode.....	3-62
MENU/PLAN/FUEL Sub-mode.....	3-64
MENU/GNSS Sub-mode .....	3-83
Active Route Modes and Functions.....	3-93
Common Function Select Keys (FSK) buttons.....	3-96
SEARCH Sub-mode.....	3-97
MAP Sub-mode .....	3-100
MAP/INFO Sub-mode.....	3-101
MAP/ERBL Sub-mode.....	3-103
FPL Sub-mode .....	3-105
FPL/VNAV Sub-mode .....	3-108
SUSP Sub-mode.....	3-111
Manually Setting the Steerpoint.....	3-111
TACTICAL INFORMATION.....	3-112
<b>4 INFORMATION DISPLAY SYSTEMS .....</b>	<b>4-2</b>
Heads Up Display (HUD) Panel .....	4-2
FLIGHT AND NAVIGATION HUD INFORMATION.....	4-3



<i>The I-251 "Shkval" Electro-Optical Targeting System</i> .....	4-12
THE HELMET-MOUNTED SIGHT (HMS) SYSTEM .....	4-16
<i>HMS Indications</i> .....	4-17
<b>5 FLIGHT PREPARATION .....</b>	<b>5-2</b>
<i>Systems Activation and Checks</i> .....	5-2
<i>ABRIS Activation</i> .....	5-3
<i>PrPNK Preparation</i> .....	5-3
<i>Activating the Weapons Control System</i> .....	5-5
<i>ADF Activation and Check</i> .....	5-5
<i>UV-26 IRCM Dispensing Program Preparation</i> .....	5-5
ENGINE START AND POWER TESTS PROCEDURES .....	5-7
<i>Preparation for Start-up</i> .....	5-7
<i>APU Start-up</i> .....	5-8
<i>APU Start-up Troubleshooting</i> .....	5-9
<i>APU Crank and False Start</i> .....	5-10
<i>Main Engines Start-up</i> .....	5-10
<i>Main Engines Start-up Troubleshooting</i> .....	5-12
<i>Engine Crank and False Start</i> .....	5-13
<i>Pre-flight Tests</i> .....	5-14
<i>Final Checks</i> .....	5-17
<b>6 FLIGHT SCHOOL .....</b>	<b>6-2</b>
GENERAL REQUIREMENTS.....	6-2
TAXI PREPARATION AND TAXI .....	6-2
<i>Taxi Initiation</i> .....	6-3
<i>Taxi</i> .....	6-3
TAKEOFF AND CLIMB .....	6-4
<i>Hover Check</i> .....	6-4
<i>Vertical Takeoff Using the Rotor-In-Ground Effect</i> .....	6-5
<i>Vertical Takeoff without Using the Rotor-In-Ground Effect</i> .....	6-5
<i>Running Takeoff</i> .....	6-6
<i>Takeoff Peculiarities</i> .....	6-6
<i>Climb</i> .....	6-6
HORIZONTAL FLIGHT AND TRANSITIONS.....	6-8
<i>Visual Flight Rules (VFR) Traffic Pattern</i> .....	6-8
<i>Transitional Flight Regimes</i> .....	6-8
DESCENT.....	6-11
<i>Descent with Operating Engines and Forward Speed</i> .....	6-11
<i>Vertical Descent with Operating Engines</i> .....	6-11
<i>Descent in Autorotation</i> .....	6-12



LANDING IN CLEAR METEOROLOGICAL CONDITIONS.....	6-14
<i>Vertical Landing Using the Rotor-In-Ground Effect</i> .....	6-14
<i>Vertical Landing Without Using the Rotor-In-Ground Effect</i> .....	6-14
<i>Roll-out Style Landing</i> .....	6-15
<i>Landing Peculiarities</i> .....	6-15
ENGINES AND EQUIPMENT SHUT DOWN .....	6-16
ROUTE, DESCENT AND HOVER MODES .....	6-17
<i>Pre-loaded Route Autopilot Flight</i> .....	6-17
<i>Flight Director Control</i> .....	6-18
<i>Changing WP Sequence in Flight</i> .....	6-21
<i>Ingress to a Target Point Using Route Mode</i> .....	6-22
<i>Return to Base Using Route Mode</i> .....	6-22
<i>Route without Task</i> .....	6-23
HOVER AND DESCENT MODES.....	6-24
<i>Hover</i> .....	6-24
<i>Vertical Descent</i> .....	6-24
HELICOPTER COORDINATE CORRECTIONS.....	6-25
<i>Coordinate Corrections Using Over-flight Method</i> .....	6-25
<i>Coordinate Corrections Using Shkval</i> .....	6-25
SPECIAL HARDWARE CONSIDERATIONS FOR CONTROLLING A HELICOPTER	
.....	6-27
<i>Flight Controller Position Indicator</i> .....	6-27
<b>7 KA-50 COMBAT EMPLOYMENT .....</b>	<b>7-2</b>
<i>Vikhr ATGM Employment Parameters</i> .....	7-2
<i>Cannon Employment Parameters</i> .....	7-2
<i>Preparations for a Combat Mission</i> .....	7-3
COMBAT PROCEDURES.....	7-4
<i>General Guidelines</i> .....	7-4
<i>Designate Target Points</i> .....	7-5
<i>Designate Targets and Ingress Points for Data Link</i> .....	7-6
<i>Data Exchange between Helicopters</i> .....	7-7
<i>Using Data Link when Approaching a Target Area</i> .....	7-8
<i>Automatic Ingress to Target</i> .....	7-9
<i>Sending Recon Orders to Flight Members</i> .....	7-9
<i>Shkval Scan Mode</i> .....	7-10
WEAPONS EMPLOYMENT PREPARATIONS .....	7-11
<i>ATGM Employment</i> .....	7-11
<i>Rocket Employment</i> .....	7-12
<i>Cannon Employment</i> .....	7-12
<i>Bombs Employment</i> .....	7-13





<i>Returning to Weapons-safe Condition</i> .....	7-13
AUTOMATIC INGRESS TO TARGET AREA.....	7-14
<i>Using Shkval to Lock Target</i> .....	7-14
<i>Using HMS to Lock Target</i> .....	7-14
WEAPONS EMPLOYMENT IN AUTOMATIC MODE .....	7-16
<i>ATGM Employment</i> .....	7-16
<i>Vikhr ATGM Launch Procedure</i> .....	7-17
<i>Using the 2A42 Cannon with Auto-tracking</i> .....	7-24
<i>Using Rockets or Fixed Cannon with Auto-tracking</i> .....	7-25
FIRING ROCKET OR CANNONS WITHOUT AUTO-TRACKING .....	7-27
<i>Firing Rockets or Cannons Using Laser-Rangefinder</i> .....	7-27
<i>Employing Rockets or Cannon with the Standby Reticle</i> .....	7-28
<i>Employing Bombs</i> .....	7-29
SPECIAL CONSIDERATIONS WHEN ATTACKING AIR TARGETS.....	7-30
<b>8 RADIO COMMUNICATIONS .....</b>	<b>8-2</b>
RADIO FREQUENCIES.....	8-2
COMMAND MENU .....	8-3
<i>Flight</i> .....	8-4
<i>Wingmen</i> .....	8-4
<i>Engage</i> .....	8-5
<i>Target Detection</i> .....	8-7
<i>Pincer</i> .....	8-8
<i>Go To</i> .....	8-9
<i>Cover Me</i> .....	8-9
<i>Jettison Weapons</i> .....	8-10
<i>Formations</i> .....	8-10
<i>Rejoin</i> .....	8-14
<i>Hold Position</i> .....	8-14
<i>Reconnaissance</i> .....	8-14
<i>Air Traffic Control</i> .....	8-16
<i>Ground Crew</i> .....	8-17
<i>Weapons Reload</i> .....	8-18
<i>Refuel</i> .....	8-20
<i>Helmet Device</i> .....	8-22
<i>Ground Electric Power</i> .....	8-23
<i>Turbo Gear</i> .....	8-24
<i>Ground Equipment Requirements</i> .....	8-25
COMMANDS AND MESSAGES .....	8-26
<i>Commands and Messages List</i> .....	8-27
<i>AI Messages</i> .....	8-30



<b>9</b>	<b>SUPPLEMENTS.....</b>	<b>9-2</b>
	MORSE CODE ALPHABET .....	9-2
	ACRONYM LIST .....	9-5
	DEVELOPERS .....	9-8
	EAGLE DYNAMICS .....	9-8
	<i>Management</i> .....	9-8
	<i>Programmers</i> .....	9-8
	<i>Designers</i> .....	9-9
	<i>Quality Assurance</i> .....	9-9
	<i>Science support</i> .....	9-9
	<i>Customer support</i> .....	9-9
	SUBJECT MATTER EXPERTS .....	9-10
	TESTER STAFF .....	9-10
	THIRD PARTIES .....	9-11
	SPECIAL THANKS .....	9-12
	TRANSLATOR TEAMS .....	9-13
	<i>French Team:</i> .....	9-13
	<i>German Team:</i> .....	9-13
	<i>Spanish Team:</i> .....	9-14
	BIBLIOGRAPHY AND SOURCES .....	9-15



1

**GENERAL  
DESIGN**

# 1 GENERAL DESIGN

## GENERAL DESIGN AND LAYOUT

The Ka-50 is a single-seat, two-rotor (coaxial) attack helicopter powered by two turbo shaft engines and supported by tricycle landing gear.

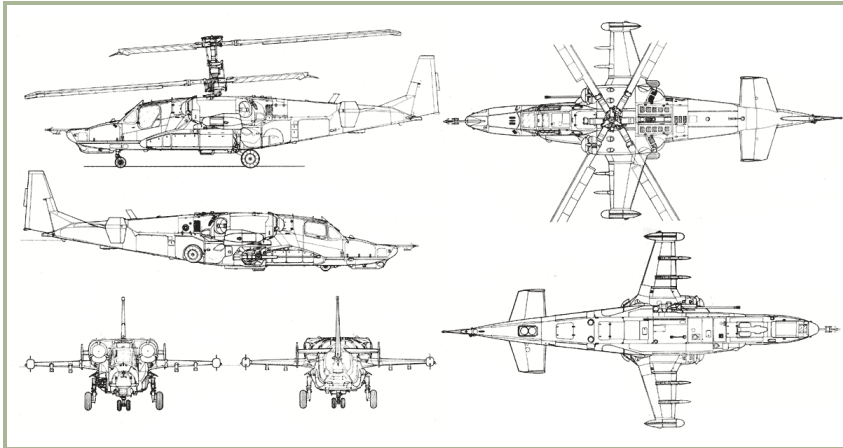

### 1-1: Ka-50 Drawings

The Ka-50 fuselage is designed as a non-pressurized, semi-monocoque structure that is divided into several sub-compartments - rectangular in midsection. Two joints sub-divide the airframe into front / rear parts and a tail unit. The fuselage is built mostly of aluminum alloys and polymer composite materials (organic plastic, carbon – fiber plastic, and honeycomb filler). The Ka-50 airframe is composed of frames, spars, ribs, heavy-duty and light-load panels, as well as door and hatch reinforcements, beams, and a stress-resistant skin. The airframe uses "hanging" panels to streamline the fuselage.

The helicopter's fixed stub-wings provide additional lift and serve as weapon attachment points. Each stub-wing is equipped with two pylons for carrying weapons, fuel tanks, and pods.

The tail unit includes a vertical stabilizer, the main horizontal fins, and widely-spaced aerodynamic rudders at the ends of the horizontal fins.



**1-2: Helicopter with open access covers and disassembled wing**

The retractable, wheeled tricycle landing gear consists of a forward strut and two main heavy-duty struts with a 2,600mm track and a 4,911mm base. The front strut tires are pressurized to  $8 \pm 0.5$  kgf/sq.cm, and the main strut tires are pressurized to  $6.5 \pm 0.5$  kgf/sq.cm.. In flight, the struts are retracted rearwards into the fuselage bays, the main struts being covered by shutters.

## POWER PLANT AND ROTOR SYSTEM

The Ka-50 power plant incorporates two TV3-117VMA turbo shaft engines, transmission gear boxes, power plant systems, and devices. The engines include a free-running turbine and a pneumatic turbo-drive starting system. The torque from the turbines is

transmitted through the intermediate and main reducing gears. Each engine measures 2055x650x728mm and develops 2,200 hp at take off with a fuel consumption of 137 g/(hp • hr).



**1-3: The exhaust nozzle of auxiliary power unit (in operate) and screen-type exhaust devices of main engine**

The main engine compartments and the Auxiliary Power Unit (APU) housing are separated by fire-proof partitions. Both engines are equipped with centrifugal dust filters and screen-type exhaust devices that mix external air with exhaust gas

to suppress the helicopter's emissions in the infrared band. The transmission system includes one main and two intermediate gears that serve to transmit power output from the main engines to the rotors and adjust their rate of rotation. The engines are designed to be started independently by means of a free-wheeling clutch that disengages one or both engines from the main reducing gear and supports helicopter flight with a single running engine or in autorotation descent mode. The main reducing gear is equipped with the front and rear drive boxes that incorporate the helicopter's system units and the main rotor braking mechanism. The auxiliary power plant incorporates the AI-9V gas-turbine engine and a pneumatic drive to feed compressed air to the turbo drive and main engines' start-up system.



**1-4: Assembly of main rotor**

The Ka-50's main rotor system is made up of two triple-blade coaxial rotors and blade control units. The upper rotor (top view) rotates clockwise and the lower rotates counterclockwise. The main rotor heads are unhinged, and the blades are attached to them through the torsion bars installed in self-lubricating bearings. The blade spars are designed as hollow beams of variable section with glass-carbon plastic partitions. The helicopter tail unit is glued to the spar's butt section. Its skin and rib facings are made of organic plastic with a polymer, honeycomb plastic filler. The blades' swept ends are fixed to the spars at an angle of 33°.

The helicopter's fuel system is comprised of two primary tanks and up to four external fuel tanks. The front tank serves to feed fuel to the port side engine, and the rear tank provides fuel to the starboard engine and to the auxiliary power unit (APU). Both primary tanks are made of kerosene-resistant rubber-fiber material. The tanks' bottoms and two-thirds of their walls are protected by layers of natural rubber. Additionally, the tanks contain polyurethane foam with an elastic, porous filler to prevent a fuel explosion if it is hit by enemy fire.

## GENERAL PURPOSE EQUIPMENT

The Ka-50's hydraulic system drives the hydraulic actuating mechanisms of the helicopter. Mechanisms served by hydraulics power include the control surface drives, the braking mechanisms of the landing gear main struts, the landing gear extension and retraction cylinders, and the cannon control units. The flight control system of the Ka-50 incorporates pitch, roll, and yaw inputs and the general pitch control unit. The flight control hydraulic inputs are then combined in the control drive unit that ensures reliable operation in both the irreversible manual control system mode and the combined control

mode (i.e., the mode combining manual control and auto-piloted flight stabilization). The Electrical Power System uses three-phase 115 V 400 Hz AC power that is supplied by two generators with an output of 80 kW and a 500 W converter. The 27 V DC supply is supplied through rectifiers. On the ground, the helicopter can also be connected to a 115 V 400 Hz external power supply unit.

The Ka-50's Warning System includes the SAS emergency warning system and the EKРАН built-in warning and control system. A Series 3 Tester U3 flight data recorder serves to record and store helicopter flight parameter data and system performance data from the last three hours of flight in case of emergency. The unit is capable of recording 38 analog and 63 digital signals. Safety of the magnetic tape is ensured by the "black box", which is sealed to be heat and impact-proof.



**1-5: Ekran built-in warning and control system (left) and auxiliary flight indicator (right) in Ka-50 cockpit**

The KKO-VK-LP oxygen supply system feeds oxygen to the pilot when at altitudes up to 6,000 m. The pilot's oxygen supply set consists of an oxygen bottle, an oxygen mask with a hose, and a gas mask. The 2-litre oxygen bottle is capable of supplying the pilot 90 minutes of air.

The deicing system prevents icing of the helicopter's most vital systems, such as the engine air intakes and dust-filtering devices, the main rotor blades, the windshield,

the air pressure sensors, the angle of attack and yaw sensors, the clock, and the icing visual indicator. Additionally, the cockpit windshield and the Shkval-V protective glass cover are equipped with defrosting liquid sprinklers and wipers.

The helicopter emergency escape system includes the K-37-800 pilot ejection system, the main rotor blade cut-off system, the cockpit escape hatch system, the ejection system attachments, and the control system.

## RADIO EQUIPMENT

The Ka-50 radio communications suite includes two R-800L1 and one R-868 VHF transceivers; an automatic data transmission system that updates ground controllers of the helicopter's position and performance; the SPU-9 intercom system; the P-503B device that records any signals coming through the pilot's headphones; and the Almaz-UP-48 voice message unit (VMU) system that is capable of providing voice warning reports to the pilot of eleven types of flight emergency situations.

The Ka-50 is also equipped with an IFF transponder, the ARK-22 radio compass, and the A-036A radio altimeter.



**1-6: The tail of the Ka-50. The white navigation light is located at the top of the image. The L-140 laser sensor system is in the center and various IFF antennas are located to each side and below**

electro-optical television sensor has either a wide or narrow field of view, with line-of-sight deflection angles of  $+35^\circ$  in azimuth and from  $+15^\circ$  to  $-80^\circ$  in elevation. The IT-23MV indicator displays a monochrome image produced by the Shkval television system.

The RANET indication system displays targeting, piloting, and navigational information on the ILS-31 head-up display (HUD). Its other purpose is to create the shapes and symbols that are displayed on the IT-23MV indicator. RANET provides a 24-degree field-of-view against the backdrop of the ILS-31 screen.

Advanced Map Moving System (AMMS):

- Flight preparation and planning
- Cartographic support for all stages of mission
- Processing of information from the linked systems
- Output of information to linked systems
- Navigation calculations for mission

The AMMS enables:

- Programming, editing and saving of waypoints, runways, radio beacons, target locations and the ability to study terrain along the flight route, etc.

The PrPNK "Rubikon" (K-041) piloting, navigation, and targeting system combines digital and analog information systems with digital combat-flight information processors. The Rubikon is based on an integrated computer system that includes five sub-units: four BCVM 20-751 computers (combat, navigational, data display, and target designation), one BCVM 80-30201 computer (weapons control systems), and one UVV 20M-800 data input/output device.

The I-251V Shkval-V targeting system incorporates TV components, a laser range finder and target designator, and a laser beam-rider system for the Vikhr ATGM system. The Shkval also provides image stabilization, variable field of views, and an automatic target-tracking system once a target is designated. The



- Ability to alter flight plan during mission
- Real-time determination of helicopter position coordinates by using built in navigational satellite system sensor (NAVSTAR/GLONASS); display of the helicopter position on the electronic moving map display; ability to cycle map scale and check cross-track error, and other necessary navigation information
- Display of aeronautical information and flight plan required for navigation during all stages of a mission
- Reception of information from the autonomous pressure altitude sensors and necessary processing of pressure altitude for the needs of the built-in satellite navigation system sensor
- Reception and processing of information from the other avionics systems such as the "Rubicon" targeting-navigation system and data link equipment.
- Indicating the position of wingmen using data link as well as targeting line of sight vector from the "Shkval" targeting system
- Annotate moving map with text and symbols



### 1-7: "ABRIS" AMMS system

The Obzor-800 target designation system is mounted on the pilot's helmet and generates control signals for the Shkval-V weapons system. Target designation is accomplished by the pilot turning his or her head within +60° (azimuth) and -20° to +45° (elevation).

The PNK-800 Radian piloting and navigation system functions as a subsystem to the Rubikon system and it affects the automated piloting and navigation systems in

combination with the other system components. The Radian incorporates the C-061K pitch-and-heading data system and the IK-VSP-V1-2 speed-and-altitude data system.

## CONTERMEASURES SYSTEMS



**1-8: UV-26 flares dispenser, left (red) navigation light and the signal flare cartridge dispenser**

The Ka-50 is equipped with the L-140 Otklik laser detection system that is capable of detecting and identifying laser guidance systems and range finders. The UV-26 system is used to dispense infrared flare decoys and dipole reflectors are carried in two 26mm cartridge pods that are fixed to the wing tips. Each pod contains 64 cartridges.

## PERFORMANCE CHARACTERISTICS

First flight, year	1982
Crew	1
Powerplant	
Type	TV3-117VMA
Takeoff power, hp	2x2,200
Dimensions, m	
Length overall, rotors turning	15.6
Wing span	7.34
Height	4.9
Main rotors diameter	14.45
Weights, kg	
Normal takeoff weight	9,800
Max takeoff weight	10,800
Fuel, l	
Internal fuel	1,870
External fuel	4x550
Speed, km/h	
Max speed at S/L	350
Cruising speed	255
Ceiling, m	
Hovering ceiling	4,000
Service ceiling	5,500
Max rate of climb m/s / altitude, m	10 / 2,500
Design G limit	3.5
Range, km	
Operational range	450
Ferry range	1,100
Armament	
ATGM, number / type	12 / Vikhr
Launching range, km	8
Cannon	
Type	2A42
Caliber, mm	30
Ammunition, rounds	220 API, 240 HE
Weight of projectile, kg	0.39



Initial speed of projectile, m/s	980
Rockets	
Type / caliber, mm / number	S-8 / 80 / 122
Type / caliber, mm / number	S-13 / 122 / 20



2

# COCKPIT CONTROLS

## 2 COCKPIT CONTROLS

### INSTRUMENT PANELS OVERVIEW

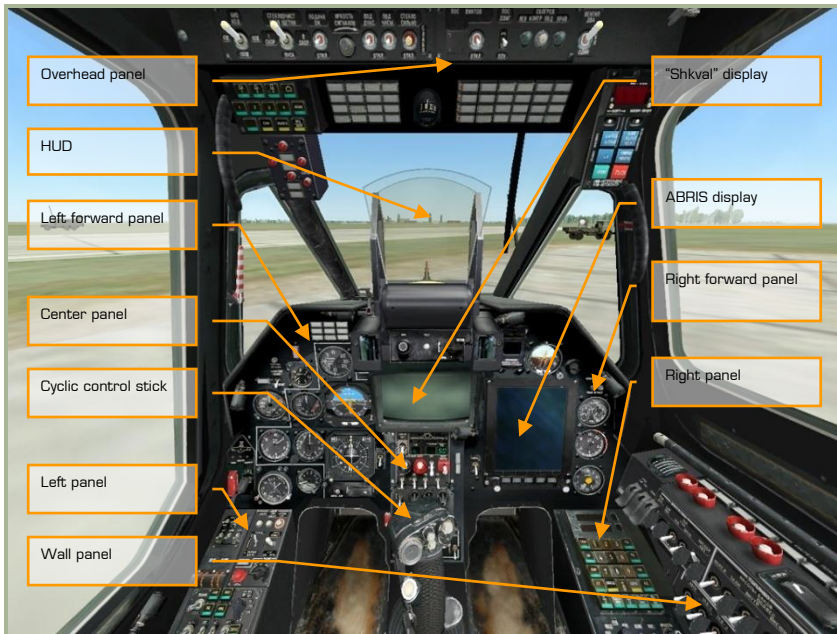

#### 2-1: Ka-50 instrument panels

The cockpit of the Ka-50 contains several instrument panels that include gauges and indicators that display flight parameters, aircraft system states, engine state, control positions, and system warnings. Owing to the single-pilot operation of the Ka-50 cockpit, all flight and weapon system controls must be accessible to the pilot, whereas they are often divided between two cockpits in a traditional, tandem seat attack helicopter. This has led to a rather crowded cockpit that at first can seem quite intimidating! However, with practice and a study of this manual, the cockpit will soon feel like home.

Many of the controls in the cockpit have pop-up tool tips displayed when the mouse is placed over them. This can be a useful tool when trying to remember the many control functions within the cockpit. These tool tips can be toggled off and on from the options menu.

Using your mouse, you may manipulate many of the controls. This can include:

- Left mouse click to toggle a switch
- Left or right mouse click to rotate a rotary dial

- Rotate the mouse wheel to spin a knob
- Left click and drag to spin a knob

When the mouse is placed over a control that can be manipulated, the cursor will turn green and provide you an icon to indicate the type of possible action. All of the mouse click functions also have keyboard press equivalents; these can be reviewed in your keyboard input control list. These keyboard commands are listed in blue within this manual.

Let's do a walk-around of the primary areas of the cockpit:

The primary flight instruments are located on the forward panels, beneath the dashboard anti-glare shield.

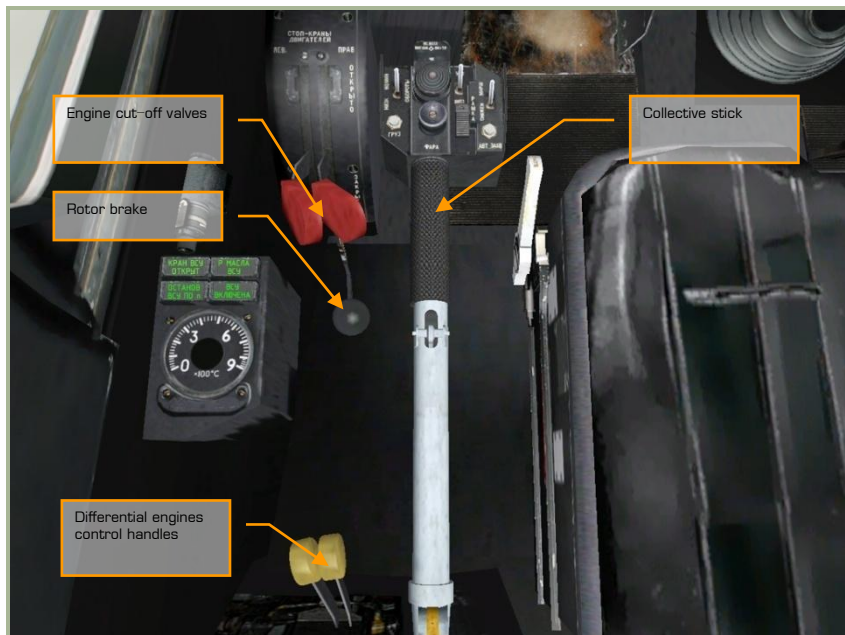

## 2-2: Power plant controls

The collective is your primary means of controlling how much lift is being generated by the rotors. When you want to generate more lift, pull back on the collective; when you wish to reduce lifting power, push the collective forward. The other controls are used during the engine start procedure and you will often not need them during the course of a mission.

- Collective up [NUMPAD + +]
- Collective down [NUMPAD + -]

The two engine cutoff valve levers open and close fuel injection into the engines. These two red levers are moved independently:

- Left engine cutoff valve [PAGE UP + RCTRL]
- Right engine cutoff valve [PAGE DOWN + RCTRL]

Behind the engine cutoff valve levers is the rotor brake:

- Rotor brake [R + LSHIFT]

The two throttles at the base of the collective are used to set the RPM of the engines and each engine can be set independently or linked:

- Linked throttles up [PAGE UP]
- Linked throttles down [PAGE DOWN]
- Left throttle up [PAGE UP + RALT]
- Left throttle down [PAGE DOWN + RALT]
- Right throttle up [PAGE UP + RSHIFT]
- Right throttle down [PAGE DOWN + RSHIFT]

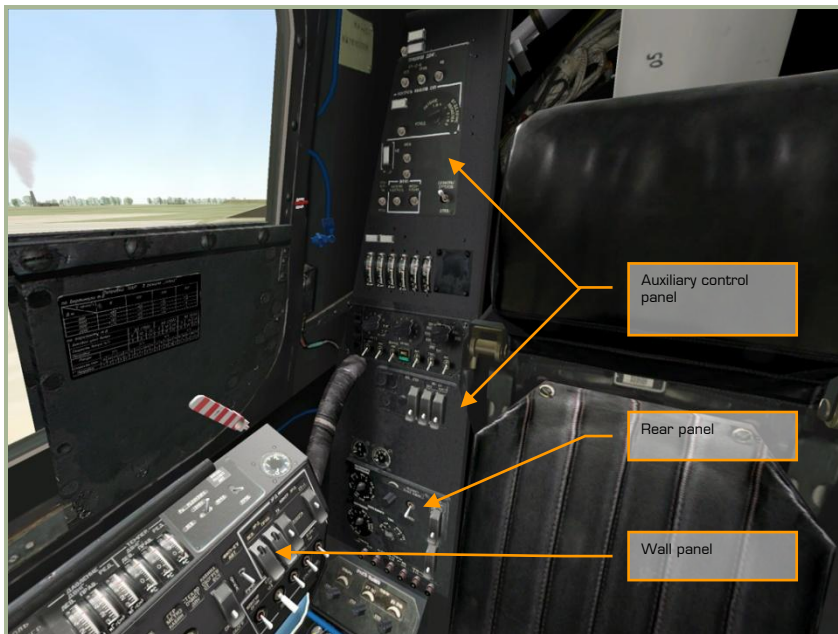

### 2-3: Side and rear panels

This portion of the cockpit has a wide array of controls that include built in tests (BIT), video recorder, countermeasures dispenser controls, weapon controls, cockpit lighting, engine governors, and engine monitoring systems to name a few.



## CYCLICK CONTROL STICK



### 2-4: Cyclic pitch control stick

The cyclic is your primary means of controlling helicopter attitude. Just like a fixed-wing aircraft, pushing and pulling the stick affects aircraft pitch and moving the stick side to side inputs roll. Unlike a fixed-wing aircraft though, you will generally pitch the helicopter forward to initiate forward flight and pull the stick back to slow down or even fly backwards.



The cyclic has a number of buttons and hats that allow you to manipulate the various systems of the helicopter without having to take your hands off the cyclic. These include:

1. **“ОГОНЬ РС – ВПУ”** (Fire weapon – cannon) triggers.
2. Wheel brake paddle [W].
3. **“ВИСЕНИЕ”** (Hover) button – Toggles the hover autopilot mode on and off [T + LALT].
4. **“РАДИО”** (Radio) button – Activates radio in transmit mode. No function.
5. **“ОСВ ПУЛЬТ”** (Gauge lighting) button – Toggles cockpit and gauges lighting on and off
6. **“ЦЕЛЬ УКАЗ”** (Uncage Shkval – confirmation) button – uncage the “Shkval” EO targeting system for target designation and confirmation of data entry (i.e. during navigation system INS fix-taking procedure) [O].
7. **“МЕТКА”** (Marker) hat switch – Slew control for “Shkval” line of sight [‘], [‘], [.] and [I].
8. **“ТРИММЕР”** (Trimmer) button – Cancels all force on cyclic with the trimming mechanisms. When released, the autopilot will stabilize current angles of pitch, bank and yaw [T]. Note that this is a different method of trimming the aircraft compared to fixed wing aircraft.
9. **“ОТКЛ АП”** (Autopilot disengage) – autopilot emergency disengage [A + LALT].

If you have a programmable control stick at home, you may wish to program it to match these settings. You can do so using the input control manger in the options screen.

## Release Weapon – Cannon Triggers

The triggers block is located on the opposite side of the stick from the pilot. Triggers are intended for generating “fire” signals for weapon system and selected weapons.

By default the **“ВПУ”** (Onboard cannon) small trigger is guarded by the larger **“РС”** (release weapon) trigger. The larger weapon trigger is intended for shooting or launching external weapons of the selected type (ATGMs, rockets, bombs, canisters and gun pods).

Note that when firing an anti-tank guided missile like the Vikhr, you will need to hold down the weapon trigger for up to a full second
---



**2-5: Weapon (large) and Cannon (small) triggers in default position – Release Weapon trigger operates**



**2-6: Weapon (large) and Cannon (small) triggers in default position – Release Weapon trigger operates**

1. **"ОГОНЬ ВПУ"** – Onboard cannon (small) trigger [SPACE]. Trigger is inoperative.
2. **"ОГОНЬ РС"** – Weapon (large) trigger [SPACE + RALT]. Trigger is operative.

For cannon employment it is necessary to flip up [C] the "PC" weapon (large) trigger. When that is done, the weapon system transmits the signal for cannon operation and the "ВПУ" cannon (small) trigger may operate.



**2-7: Weapon (large) and Cannon (small) triggers in Cannon operate position (Release Weapon (large) trigger is flipped up)**

1. "ОГОНЬ ВПУ" – Onboard cannon (small) trigger [SPACE] is operative.
2. "ОГОНЬ РС" – Weapon (large) trigger is inoperative.

## COLLECTIVE CONTROL STICK



### 2-8: Collective control stick

In addition to adjusting the pitch of the rotor blades and thereby affecting main rotor lift, the collective also has a number of buttons, hats, and switches that allow you to manipulate certain functions. These include:

1. **"ОБОРОТЫ"** Control selector for re-adjustment of the free-turbine (rotors) RPM governor. To low [NUMPAD - + RALT] and to nominal [NUMPAD + + RALT].
2. **"ГРУЗ"** Sling load button - No function.
3. **"ФАРА"** Hat switch. Slew search/landing lights. [; + RCTRL], [, + RCTRL], [. + RCTRL] and [/ + RCTRL].
4. **"РАМКА"** selector – Adjust "Shkval" tracking gate size [I] and [J].
5. This four position hat allows the selection of external hardpoints.
  - o **"ВНЕШН"** – Outboard hardpoints [Y].
  - o **"ВНУТР"** – Inboard hardpoints [I].



- **"4П"** – All hardpoints [U].
  - **"ПС ВОЗД"** – Air-to-Air missiles hardpoints [U + LCTRL]. (No function)
6. **"УПЗ-ШПЗ"** switch. Adjust Shkval field of view (FOV) between 23x and 7x: wide [-] and narrow [=].
  7. **"СНИЖЕН – МАРШ"** switch. Three position switch between Off, Descent, and Route autopilot modes [D] and [R].
  8. **"АВТ ЗАХВ"** button. Toggles target acquisition and lock when using Shkval [ENTER].
  9. Collective brake - Assign altitude lever [F]. This lever serves two functions:
    - Press this lever to disengage the collective stick brake before moving the stick. The brake is needed to prevent the stick from moving due to vibration or casual touch.
    - Once the brake has been released and a signal is sent to the navigation system, the lever can be used to assign a new altitude when using the altitude hold flight mode.





1. Master caution push-light – Resets the light to off when pressed [M]. The master caution light will turn on anytime a warning or caution light is activated
2. Caution lights panel
3. Vertical Velocity Indicator (VVI)
4. Attitude Director Indicator (ADI)
5. Barometric altimeter
6. Horizontal Situation Indicator (HSI)
7. Automatic/Manual course and heading source switch
8. Laser rangefinder/designator mode switch
9. Laser designator reset button
10. Rotor pitch indicator
11. Mechanical Clock
12. Gear position indicator
13. Rotor RPM indicator
14. Radar altimeter
15. Indicated airspeed indicator
16. Rotor RPM warning push-light [B]
17. Missile warning system with laser jammer, self protection system mode of operation select, No function
18. Warning, Cautions, and Advisory lamps test button [L + LSHIFT]
19. Accelerometer

Details of the above gauges and indicators are described below.

Note that the example gauge and indicator readings shown in figures may not be indicative.



## Right Forward Panel

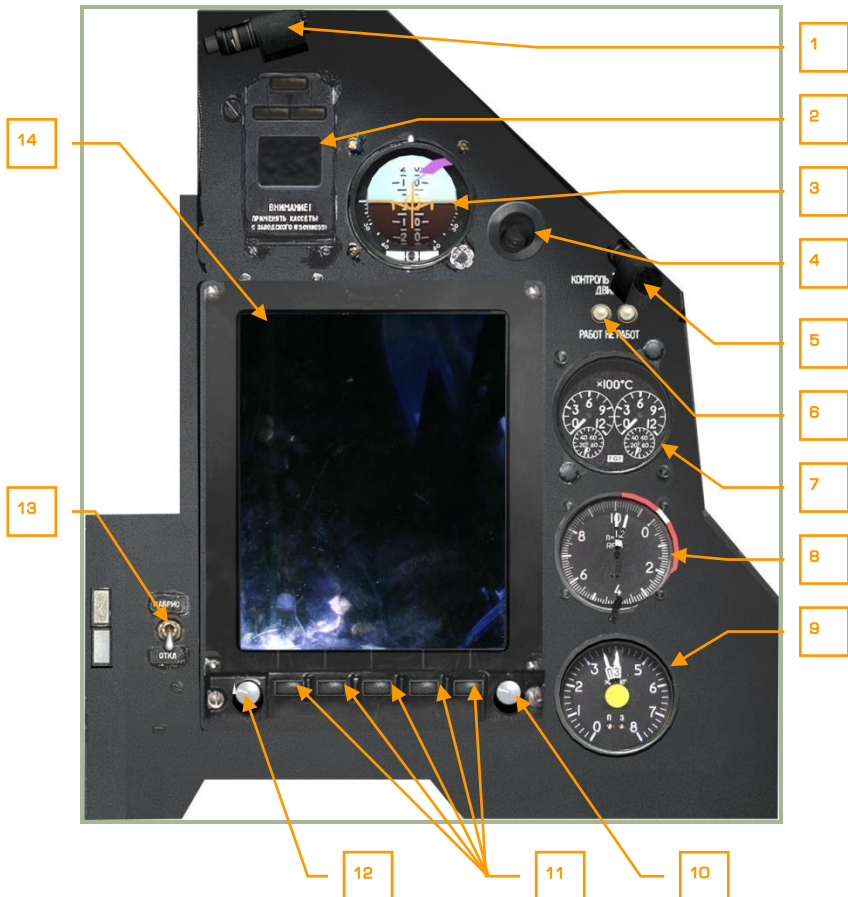

### 2-10: Right forward panel

The right forward panel is dominated by the ABRIS display, but also includes gauges for flight control, test devices, engine management, and fuel management.

1. Cockpit light
2. EKRAN Warning System display
3. Standby Attitude Indicator (SAI)
4. Cockpit air conditioner vent
5. Night light
6. Exhaust gas temperature indicator test buttons



7. Exhaust gas temperature indicator
8. Dual engine RPM indicator
9. Fuel quantity indicator
10. ABRIS cursor control
11. Multi-function ABRIS buttons
12. ABRIS brightness display knob
13. ABRIS On/Off switch
14. ABRIS display

Please see the ABRIS section of this manual for a detailed explanation of this sub-system.

## Attitude Director Indicator (ADI)

The Attitude Director Indicator (ADI), also referred to as the "artificial horizon," indicates the helicopter's orientation relative to the horizon.

To operate the ADI, electrical power will need to be active after the Inertial Navigation Unit (INU) power-up sequence is complete.

The ADI includes the following indications:

- Pitch (fore and aft tilt) and bank (side to side tilt) angles
- Desired pitch and bank (to reach the next waypoint)
- Assigned airspeed
- Assigned altitude
- Lateral deviation from assigned flight path or hover position
- Yaw angle
- ADI malfunction



### 2-11: Attitude and Direction Indicator (ADI)

1. **Lateral deviation from assigned flight path.** Located at the top of the ADI, this line indicates the degree to which the aircraft is flying along the assigned heading along the route leg. If the aircraft is flying along the correct heading, the vertical line will be centered in the window. If, however, the line is on the right side, you are flying to the left of the desired flight path and vice versa if the line is to the left.
2. **Assigned pitch and bank steering not available flag.** If no steering information is available, this red flag will be visible in the top left corner of the ADI.
3. **Deviation from assigned airspeed.** Along the left side of the ADI is a vertical scale that represents the aircraft's current speed in relation to the set airspeed for the current leg of the route. If the indicator is below center, it indicates that the aircraft is traveling too fast and vice versa if the line is above center.
4. **Aircraft symbol.** Appearing like a fixed-wing aircraft, this symbol indicates current aircraft pitch and roll in relation to the artificial horizon. Note that it is different from western ADI instruments that have a static aircraft symbol. With the Russian-style ADI, the aircraft will move according to bank angle.
5. **ADI malfunction flag.** If the INU is not providing attitude information or the ADI is not receiving power, this flag will be visible.
6. **Self-test button.** The first press of this button will open the cover [A + LALT + LCTRL + LSHIFT] and a second press will run a self-test [A + LALT + LSHIFT].
7. **Pitch scale.** Displayed in large 10 degree increments with 5 degree hash marks between, these lines are inscribed on the ADI artificial horizon ball and indicate aircraft pitch angle in relation to the aircraft symbol.



8. **Bank steering bar.** This vertical, gray bar can move to the left and right and indicates the level of bank needed to align the aircraft on the correct steering course. If the aircraft is on course or no steering information is available, the bar will be centered.
9. **Deviation from assigned altitude.** This vertical scale and yellow caret on the right side of the ADI indicates the aircraft's current altitude in relation to the assigned altitude for the current leg of the route. If the aircraft is too high or too low, the caret will be below or above the center mark. The caret being above the center point would indicate that the aircraft was below the assigned route leg altitude.
10. **Pitch steering bar.** This horizontal, gray bar can move up and down and indicates the pitch angle needed to align the aircraft on the correct steering course altitude. If the aircraft is on course at the correct altitude or no steering information is available, the bar will be centered.
11. **Aircraft symbol setting knob.** This knob can be rotated left [**L**, **+ LALT + LSHIFT**] and right [**R**, **+ LALT + LSHIFT**] to move the horizon line on the ADI ball vertically. You can use this function to fix any misalignment before flight. This control can also be used to "zeroise" the horizon indication for the given angle-of-attack. This can be useful in simplifying the level flight control at a given airspeed.
12. **Yaw indicator.** Indicating the yaw of the aircraft, this indicator displays a ball in a liquid filled tube. If there is no yaw in the flight path, the ball will be centered. If there is yaw, the ball will be displayed in the opposite direction of yaw. The sideslip indication ball moves by local acceleration so it will not always display the actual sideslip. This depends much on the type of maneuver you are flying.

## Horizontal Situation Indicator (HSI)

The Horizontal Situation Indicator (HSI) is located in the left forward panel and it displays aircraft heading, offset from the assigned flight path, and position relative to a selected navigation reference that may be a steerpoint, fixed point, radio beacon, or airfield.

Although primary navigation data may be displayed on the HUD, the HSI provides additional information for precise navigation.

To operate the HSI, electrical power will need to be enabled and either the "K-041" or "Navigation System" switch must be set to ON. The HSI will operate after INU alignment is complete.

### Waypoint vs. Steerpoint

Often incorrectly used interchangeably, the two terms are in fact different. A waypoint is a list of navigation points that have unique coordinates and names. A steerpoint on the other hand is the current waypoint that is selected for navigation. As such, there can be many waypoints but there can only be one steerpoint at a time.

The HSI includes the following indications:

1. Current heading (demarcated in 5° increments).

2. Desired flight path heading, according to flight plan or entered manually.
3. Desired course (shown both with analog needle and digital counter), according to flight plan or entered manually.
4. Distance to steerpoint.
5. Bearing to a radio station, as measured by the ARK-22 radio-compass.
6. Lateral deviation from the assigned flight path or hover position.
7. Longitudinal deviation from an assigned hover position.



### 2-12: HSI Indicator

1. **Heading unreliable, "KC" flag.** If the INU fails to provide current heading, or the HSI is not receiving power, this flag at the top of the instrument will be visible.
2. **Distance steerpoint.** Shown as a numeric, this number indicates the direct range to the steerpoint in kilometers.
3. **Desired heading (DH) index.** This thick yellow line indicator on the outside of the compass card indicates either the desired heading to steerpoint or a manually set heading.
4. **Navigational computer failure "K" flag.** If navigational computer BIT continually fails, this flag on the left side of the instrument will be visible.
5. **Desired Track Angle (DTA) pointer.** This arrow is according to flight plan or entered manually. This indicator appears as two white lines with an arrow at the end. A corresponding "tail" exists 180 degrees on the opposite side of the compass.

6. **Longitudinal deviation from an assigned hover position.** This horizontal, gray line in the center of the instrument indicates the helicopter's relative longitudinal hover position compared to when hover mode was initiated. If the line is below the center point it indicates that the helicopter is hovering too far forward of the initial hover point. Conversely, if the line is above the center point it indicates that the helicopter has moved too far backwards. Ideally, you want the horizontal and vertical lines to form a cross in the center.
7. **Self-test button.** Press this button to run a self-test of the instrument. [H + LALT + LCTRL]
8. **Desired Heading set knob.** If the "DH/DTA source" switch is set to the Manual position, this knob may be rotated left [, + LCTRL + LSHIFT] and right [. + LCTRL + LSHIFT] to manually set the desired heading index to steerpoint.
9. **Current heading reference arrow.** At the top of the compass card is a downward pointing arrow that indicates the current heading of the aircraft when matched with the compass heading below.
10. **Desired Track Angle digital counter.** Shown as a numeric, this number indicates either desired track angle to the steerpoint or a manually selected number in degrees.
11. **Compass card.** This circular gauge rotates according to current aircraft heading. The current heading is shown at the very top of the card underneath the heading reference arrow.
12. **Lateral deviation from the assigned flight path or hover position.** This vertical, gray line in the center of the instrument indicates the helicopter's relative lateral position compared to when hover mode was initiated, or to the assigned flight path between previous and current steerpoints. If the line is to the left of the center point it indicates that the helicopter is hovering too far to the right. Conversely, if the line is to the right it indicates that the helicopter has moved too far to the left. Ideally, you want the horizontal and vertical lines to form a cross in the center. Note that if Hover mode is inactive and the "Heading/Course flight path mode" on the Autopilot panel is set to the Heading position, that the deviation indicator will become inactive (will be centered). In the Heading mode, direct flight to the steerpoint method is used.
13. **"ЗПУ-ЗК РУЧН – АБТ" (DH/DTA source) switch.**  
This switch is used to select between automatic and manual desired heading and desired track angle setting of the HSI. When in the default down position, automatic "АБТ" mode is selected. When in automatic mode, the heading and course pointers will be updated by the navigation system and automatically change according to the current waypoint. When in the up position, manual "РУЧН" mode is selected and the DH and DTA knob is used to adjust the pointers. [H + LCTRL]
14. **Navigational computer failure "Г" flag** (same as item 4). If the navigational computer has a continuous BIT failure, this flag will appear on the right side of the instrument.
15. **RMI bearing to radio station.** This small yellow arrow points to the bearing of the selected radio station. This bearing is read from the OUTER, non-moving

scale and the radio station is selected via the ARK-22 Automatic Direction Finder control panel.

16. **Outer scale.** This static scale has markings for 6, 12, 24, and 30, and is used to read bearing to the radio station indicated by the yellow arrow.
17. **Desired Track Angle knob.** If "DH/DTA source" switch is in the Manual position, this knob may be rotated left [ , + LALT + LCTRL] and right [ . + LALT + LCTRL] to set a DTA manually to steerpoint pointer.

## Laser Designator Panel



### 2-13: Laser designator panel

1. The small "СБРЭС ЛДП" laser designator reset button is used to cease laser illumination, if it has not already timed out after 20 sec. [O + LALT + LCTRL]
2. The laser range finder / laser designator mode toggle "ЛД-ЛДП" switch is located directly below the HSI and is set to the "ЛД" laser range finder position by default. [O + LSHIFT] When set to the "ЛДП" laser designator position, the laser can be used to designate targets for weapons such as the Kh-25ML, Kh-29L or laser bombs. The Ka-50 can search for a target and illuminate it for 20 seconds by a second press of the ENTER key. This switch does not affect "Vikhr" employment.

## Rotor Pitch Indicator

The rotor blade pitch indicator is used to monitor the pitch angle of the rotor blades. The collective pitch control can be used to increase rotor pitch up to 15°.

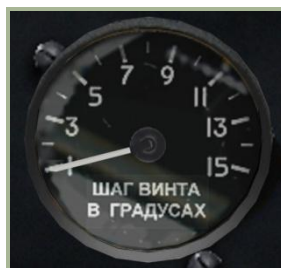

### 2-14: Rotor blade pitch indicator

## Barometric Altimeter

The barometric altimeter indicates the aircraft's current altitude above sea level (ASL). The altimeter dial has two hands: one full rotation of the long hand represents 1,000 meters and one full rotation of the short hand represents 10,000 meters.

The altimeter has a calibration knob for QFE pressure setting of local barometric pressure (shown in the small window). The scale on the pressure dial is demarcated in millimeters of mercury (mmHg). The local air pressure is usually entered while the helicopter is stationary on the ground.



### 2-15: Barometric altimeter

1. Short hand (1,000 meters)
2. Long hand (meters)
3. QFE knob can be rotated left [- + RSHIFT] and right [= + RSHIFT]
4. Desire altitude bug (set manually)
5. QFE pressure scale in millimeters of mercury (mmHg). The red tick mark indicates normal pressure 760 mmHg.



## Vertical Velocity Indicator (VVI)

The VVI measures the aircraft's rate of climb or descent. Vertical velocity is measured in meters per second (m/s) and the maximum measured values are  $\pm 30$  m/s.



**2-16: Vertical Velocity Indicator (VVI)**

## Rotor RPM Indicator

The rotor RPM indicator displays the tachometer measurement of rotor's revolutions per minute (RPM) as a percentage of its maximum value. This instrument does not require any electrical power.

If the rotor RPM falls below the minimum safe value of 83% or increases over 98%, the yellow "HB" (Rotor) warning push-light on the left forward panel will flash, and an audio warning is heard in the pilot's headphones. To reset the warning, you may click on the push-light. [R + LALT + LCTRL]

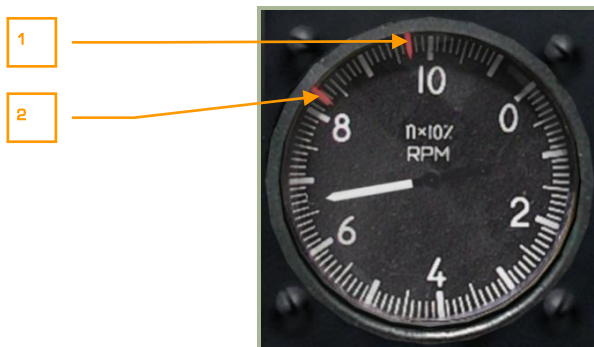

**2-17: Rotor RPM indicator**

1. Maximum allowed rotor RPM – 98%
2. Minimum safe RPM in flight – 83%

## Airspeed Indicator

The airspeed indicator displays the aircraft's forward velocity. The indicated values start at 20 km/h and use an expanded scale up to 50km/h. After 50km/h, the scale is demarcated in 10km/h increments. The indicator though is incapable of measuring IAS below 50-70 km/h or when flying backwards.



**2-18: Airspeed Indicator**

## Accelerometer

The accelerometer (or "G-meter") indicates the current maneuver loading on the helicopter; it is measured in regards to normal gravity (1 G). The red needles indicate the highest and lowest G attained during a sortie. A button in the lower right of the scale is used to reset the lowest and highest attained G.

The scale starts at 1 G (the earth's normal gravity) and is demarcated from -2 to +4 G.



**2-19: Accelerometer ("G-meter")**

1. Lowest G attained
2. Current G
3. Highest G attained
4. Reset needles button [- + LSHIFT]

## Radar Altimeter

The radar altimeter displays the helicopter's altitude above ground level (AGL), to a maximum altitude of 300 m AGL. Altitude is measured by a small, downward-facing radar.



### 2-20: Radar Altimeter

1. Yellow safe altitude threshold bug set by the safe altitude setting knob.
2. A TECT (Test) button for testing the instrument. When this button is pressed, the arrow moves to 15 m altitude and indicates that the altimeter is functioning properly. [R + LALT + LSHIFT]
3. Instrument failure flag. Presence of this flag indicates that the altimeter is not operating.
4. Combined knob for setting the minimum safe altitude and yellow warning lamp. The triangle yellow warning lamp will illuminate after reaching safe altitude during the descent of the helicopter. Simultaneously, a warning tone will be heard. The knob may be rotated left [ , + LSHIFT] and right [ . + LSHIFT].

The scale is calibrated from 0 to 300 meters and has the following sub-ranges:

- From 0 to 20 m – demarcated in 1 m increments
- From 20 to 50 m – demarcated in 2 m increments
- From 50 to 200 m – demarcated in 10 m increments
- From 200 to 300 m – demarcated in 50 m increments

When flying above 300 m AGL, the arrow goes up to the 300 m sector and the failure flag will drop out to indicate that the altimeter is not operating.

The radar altimeter turns on with activation of the targeting–navigation system by setting the K-041 switch to ON. About 10 seconds after powering on, the arrow will turn to the max range and then go back; the warning flag will go off simultaneously. When the pointer arrow turns past 0, the safe altitude threshold bug will snap into action and the warning yellow lamp and audio warning tone will be heard.

## Clock

The mechanical clock displays the current time of day in hours, minutes, and seconds. It can also be used to measure mission time in hours and minutes, and as a chronometer to measure short time periods (up to an hour) in minutes and seconds.



### 2-21: Clock

1. Mission time clock dial
2. Time of day clock dial
3. Stop-watch clock dial
4. Mission time indicator
5. Right knob
6. Left knob

Clock functions include:

The time of day display operates continuously. Mission time can be activated as desired by pressing the left knob [C + RALT + RCTRL + RSHIFT]. The stop-watch can be activated as desired by pressing the right knob [C + RALT + RSHIFT].

To set the time, rotate the right button crown clockwise [., + RCTRL + RSHIFT] when the second hand points to 12: this will stop the clock. Then pull the left button crown [M + RSHIFT] while holding down the right mouse button and rotate it counter-clockwise [., + LALT] or clockwise [., + LALT] to set the desired time. Rotating the right button crown counter-clockwise again resumes clock operation with the new time setting [., + RCTRL + RSHIFT].

Mission time is indicated on the small scale at the top of the clock face. Press the left red button to start the timer [C + RALT + RCTRL + RSHIFT]. A red light will glow, and the timer will start ticking. To stop the timer, press the red button again [C + RALT + RCTRL + RSHIFT]. A red-and-white dot will appear on the timer scale. To reset this timer, press the red button once again [C + RALT + RCTRL + RSHIFT] or [M + RSHIFT].

The stop-watch is the small scale at the bottom of the clock face and is used to accurately measure short time spans (up to 1 hour). It is controlled with the white button on the right, in a similar fashion as the mission time clock.

The clock spring is wound manually by rotating the left button crown to its mechanical stop. The spring contains enough energy for two days of operation.

## EKRAN System

The internal diagnostic and warning system communicates audio and text messages to the pilot via the EKRAN-32-03 display. The EKRAN display is located on the right forward panel.

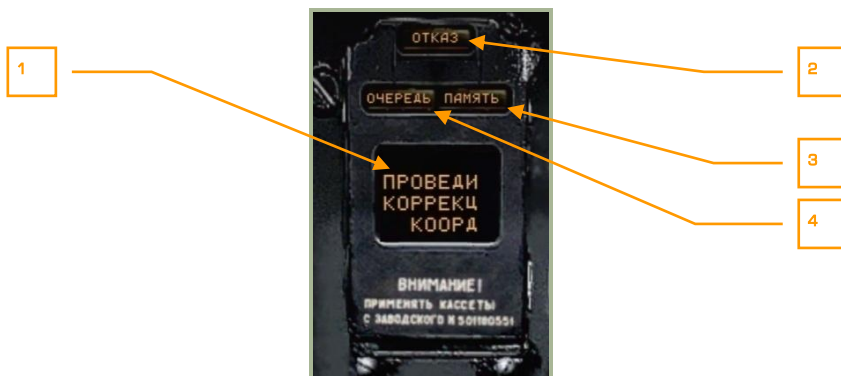

### 2-22: Universal signal panel of the EKRAN system

1. Display window
2. FAIL light
3. MEMORY light
4. TURN light

The EKRAN-32-03 ("EKRAN" for short) Built-In Test (BIT) display is part of the integrated cockpit information system. EKRAN functions include:

- Diagnostics of all aircraft systems and components that informs the pilot of any failures, and (in the system-tracing mode) indications of any equipment operation abnormalities in flight.
- Equipment diagnostics using built-in sensors, and documenting test results during pre-flight checks and ground maintenance.

The EKRAN can be activated by setting the "ВМГ ГИДРО ЭКРАН" (Power plant, hydraulics, EKRAN self-test systems) switch [N + LCTRL + LSHIFT] (located on the bottom portion of the auxiliary control panel) to the down position. In case of an emergency, backup electrical power is provided to the EKRAN system from the onboard batteries. [H + LALT + LSHIFT]

The EKRAN operates in two modes:



- Flight Control
- Ground Control, No function

When in the Flight Control mode, the EKРАН provides the following functions unless power is no longer provided:

- Display of text messages regarding system failures and emergency operation of the components and systems. The messages will provide a recommendation to the pilot (for example: **“ПРОВЕДИ КОРРЕКЦ КООРДИНАТ”** (CHECK COORDINATES CORRECTION), to attract pilot’s attention to the cockpit warning system. This warning system generally consists of the flashing master warning light (MWL) and a voice message.
- Storing incoming data for further prioritization and then sending it to the EKРАН display to be accessed by the pilot.
- Documenting the incoming data to the EKРАН information on a special tape with indications of the receiving times calculated from the moment the EKРАН is switched on.
- Automatic printing to tape of the digital codes of the last 64 registered messages (between EKРАН start-up and shut-down).

Depending on the number of controlled parameters, Flight Control mode can be divided into four stages:

1. From EKРАН start to engines start-up.
2. From engines start to take off and landing to EKРАН powered off.
3. Flight.
4. Print the last 64 signals that occurred in flight and eight seconds after landing.

## First stage

The first stage begins the moment the EKРАН is turned on and ends when either engine cut-off valve is placed in the OPEN position or a throttle lever is moved to the AUTO position. To avoid premature failure indication during startup, the following engine and gearboxes parameters indication are engaged only:

- **“ДАВЛЕНИЕ МАСЛА ПРИВОДОВ”** (ACCESSORY OIL PRESS)
- **“ДАВЛЕНИЕ МАСЛА ЛЕВ/ПРАВ РЕД”** (GEARBOX OIL PRESS LEFT/RIGHT)
- **“ПРЕДЕЛ ВИБРАЦИЯ ЛЕВ/ПРАВ ДВ”** (CRITICAL VIBRATION LEFT/RIGHT ENG)
- **“ТЕМПЕР МАСЛА РЕД ЛЕВ/ПРАВ”** (GEARBOX OIL TEMP LEFT/RIGHT)
- **“СТРУЖКА ЛЕВ/ПРАВ ДВ”** (LEFT/RIGHT ENGINE CHIP)
- **“ДАВЛЕНИЕ МАСЛА ЛЕВ/ПРАВ ДВ”** (LEFT/RIGHT ENG OIL PRESSURE)
- **“ДАВЛЕНИЕ МАСЛА ГЛАВ РЕД”** (MAIN GEARBOX OIL PRESS)
- **“ТЕМПЕР МАСЛА ГЛАВ РЕД”** (MAIN GEARBOX OIL TEMP)



- **“СТРУЖКА ГЛАВ РЕД”** (MAIN GEARBOX CHIP)

### **Second stage**

The second stage starts when either throttle lever is placed in the AUTO position and ends at takeoff (engagement of the landing gear handle). All data of the monitored systems, components, and modes are engaged except for those turned on at takeoff. After landing, the **“ДОКУМЕНТ”** (DOCUMENT) message is printed on the EKRAN display and the second stage of EKRAN operation will continue until all helicopter power is shut off.

### **Third stage**

The third stage, FLIGHT, begins at lift-off (engagement of the landing gear handle) and the recording of the takeoff time is calculated from the turning on of the EKRAN and the appearance of the **“РЕЙС”** (FLIGHT) message on the EKRAN display. When in the FLIGHT stage, all system, component, and mode monitoring data is connected to the EKRAN, and only part of the data is indicated on the display. The rest of the data is recorded in EKRAN memory. 11 emergency messages are indicated by red lights on the emergency message lamps. Additionally, an audio message of the emergency will be played twice.

Messages played on the display with frame change are accompanied by the audio message **“СМОТРИ ЭКРАН”** (WATCH EKRAN). If the **“ВКЛ АВАР”** (ON EMERG) switch (on the bottom of center panel) is placed in the EMERG position, the voice messages corresponding to the stored messages will play.

This stage ends eight seconds after landing (landing gear compression).

### **Fourth stage**

The Fourth stage consists of the automatic printing to tape of the digital codes of the last 64 messages that occurred during the FLIGHT stage. This begins eight seconds after landing and is indicated by the display of the DOCUMENT message on the EKRAN display. The print-out lasts for about 20 seconds and ends the fourth stage. The second stage continues until all the power on the helicopter is shut off.

Messages recorded on tape and in the memory continue in all stages of operation, while print from the memory is possible only for signals that occurred during the FLIGHT stage.

### **Priority**

Messages are sent to the display after prioritization. In case of a simultaneous collection of messages, the one with the highest priority is displayed, and the **“ОЧЕРЕДЬ”** (ORDER) message appears.

Every new recording to memory of a message is followed by a flashing MWL. Messages can be reviewed by contiguously pressing the MWL.

After the first MWL press, the flashing mode disengages; after the second press, the message displayed on the EKRAN goes to memory, which displays a **“ПАМЯТЬ”** (MEMORY) light on the EKRAN display and then the next signal is displayed. After all messages are reviewed, the MEMORY light goes off; the last signal remains on the EKRAN display.

## Digital Message Codes

Digital messages are displayed during print in the following format: message code (three digit number) – time of receiving the signal (four digit number).

In the example below: The first message has code 132, the time of receiving 00 minutes, 17 seconds after turning on the EKRAN, the second message has code 066, time is 03 minutes, 20 seconds.



### 2-23: Digital codes of the messages for print 8 sec after landing

1. Signal digital code
2. Time – tens of minutes
3. Time – units of minutes
4. Time – tens of seconds
5. Time – units of seconds

## Service messages on the EKRAN display in Flight Control mode

САМОКОИТ	SEFLTEST	Beginning of the built-in test (BIT)
ЭКРАН ГОДЕН	EKRAN READY	End of the BIT – EKRAN is serviceable
ЭКРАН ОТКАЗ	EKRAN FAILURE	End of BIT – failure detected
РЕЙС	FLIGHT	FLIGHT stage beginning
ДОКУМЕНТ	DOCUMENT	Beginning of DOCUMENT stage



**Table of messages in FC mode**

Number in catalogue	Priority	Message (Rus/Eng)		Description
1	1	ПРИНЯТЬ ЦУ	RECEIVE DL TARGET	Information about incoming target via data link
2	2	ОСНОВНАЯ ГИДРО	MAIN HYDRO	Main hydraulic system failure
3	3	ОБЩАЯ ГИДРО	COMMON HYDRO	Common hydraulic system failure
4	4	ВЫПУСТИ ШАССИ	EXTEND GEAR	Landing gear is not down and locked Low level flight with descent and IAS < 30.0 km/h
5	5	ДАВЛЕНИЕ МАСЛА ГЛАВ РЕД	MAIN GEARBOX OIL PRESS	Minimum main gearbox oil pressure
6	6	ТЕМП МАСЛА ГЛАВ РЕД	MAIN GEARBOX OIL TEMP	Main gearbox oil overheat
7	7	СТРУЖКА ГЛАВ РЕД	MAIN GEARBOX CHIP	Main gearbox chip
10	8	ВКЛЮЧИ ЗАП КОД ОТВЕТЧИК	TURN ON BACKUP TRANSP	Turn on backup code of IFF
11	9	СЕТЬ НА АККУМУЛ	ELEC ON ACCUM	Helicopter is on battery bus
30	24	РАБОТАЙ С ИТ	USE TV	K-041 failure, use the TV channel of the «Shkval»
31	25	ВКЛЮЧИ РУ РАБОТАЙ С КИ-ИТ	TURN ON MAN ATCK USE HUD-TV	Combat computer failure during ATGM launch
34	28	ВКЛЮЧИ РЗН	TURN ON NAV BACKUP	Navigation computer failure. Turn navigation tasks backup
14	12	ОТКАЗ	WPN CTRL	Rockets control failure



		СУО-РС	ROCKET FAILURE	
247, 250	13	ОТКАЗ ППУ	GUN DRIVE FAILURE	Gun drive system failure Gun control system failure
16	14	ПЕРЕДНИЙ БАК 110	FORWARD TANK 110	Forward fuel tank low fuel level
17	15	ЗАДНИЙ БАК 110	REAR TANK 110	Rear fuel tank low fuel level
20	16	ОБЛЕДЕН ВКЛЮЧИ ПОС ВИНТ	TURN ON ROTOR ANTIICE	Icing detected
21	17	РАДИО ВЫСОТОМ	RADAR ALT	Radio altimeter failure
22	18	КУРСО-ВЕРТИК	INU	Inertial navigation unit failure
23	19	ОТКАЗ ЭЗУ-Ц	DL MEMORY FAILURE	Datalink computer memory failure
24	20	ВКЛЮЧИ СЕТКУ РАБОТАЙ С НПУ	TURN ON SBY RTCL USE FIX GUN	K-041 gun steering connection component failure
25	21	РАБОТАЙ С НПУ	USE FIX GUN	K-041 gun steering control channel failure
26	22	ОТКАЗ ТЕЛЕКОДА	DATALINK FAILURE	Data link failure
40	31	ВКЛЮЧИ ПРЕОБРАЗ	TURN ON INVERTER	Switch inverter to manual
44	35	ОТКАЗ ЛР-РЭП	LWS FAILURE	LWS all channels failure
45	36	ДАВЛЕНИЕ МАСЛА ЛЕВ РЕД	LEFT GEARBOX OIL PRESS	Left gearbox minimum oil pressure
46	37	ТЕМПЕР МАСЛА ЛЕВ РЕД	LEFT GEARBOX OIL TEMP	Left gearbox oil overheat
47	38	СТРУЖКА ЛЕВ РЕД	LEFT GEARBOX	Left gearbox chip

			CHIP	
50	39	ДАВЛЕНИЕ МАСЛА ПРАВ РЕД	RIGHT GEARBOX OIL PRESS	Right gearbox minimum oil pressure
51	40	ТЕМПЕР МАСЛА ПРАВ РЕД	RIGHT GEARBOX OIL TEMP	Right gearbox oil overheat
52	41	СТРУЖКА ПРАВ РЕД	RIGHT GEARBOX CHIP	Right gearbox chip
53	42	ДАВЛЕНИЕ МАСЛА ПРИВОДОВ	DRIVE OIL PRESS	Accessory gearbox minimum oil pressure
54	43	ВКЛЮЧИ БЛОКИР СУО	TURN ON ARM SYS SAFE SW	Weapon system users are off
55	44	РЕЗЕРВ АВИА ГОРИЗОНТ	STANDBY ATTITUDE IND	SAI failure
56	44	ОТКАЗ ОБОГРЕВА ПВД ЛЕВ	LEFT PROBE HEAT FAILURE	Left pitot heating failure
57	44	ОТКАЗ ОБОГРЕВА ПВД ПРАВ	RIGHT PROBE HEAT FAILURE	Right pitot heating failure
60	45	ИК-ВСП	AIR DATA SYS	Air data system failure
61	46	ДИСС	DOPPLER NAV SYS	Doppler device for ground speed and drift angle failure
41	32	НЕСХОД ИЗДЕЛИЯ	HUNG WEAPON	Weapon not launched
42	33	ОТКЛЮЧИ СОЭП-РЭП	TURN OFF L-140	Turn off L-140
62	47	КАНАЛ КУРСА	HEADING INVALID	Heading channel failure
63	48	НЕТ СЧИСЛЕН КООРД	NAV POS INVALID	Navigation coordinates calculation failure



64	49	СБОЙ РАСЧЕТА МАРШРУТА	ROUTE NAV FAILURE	Route navigation failure
65	50	ЭЗУ-Н	NAV DATA MEMORY FAILURE	Navigation computer memory failure
66	51	ПРОВЕДИ КОРРЕКЦ КООРД	PERFORM NAV POS FIX	Enter area coordinates for correction (within R~18 km of the fix point)
67	52	ЛЕВ ГЕНЕР	LEFT GEN	Left generator failure
70	53	ПРАВ ГЕНЕР	RIGHT GEN	Right generator failure
71	54	ЛЕВ ВЫПРЯМИТ	LEFT DC RECTIF FAILURE	Left rectifier failure
72	55	ПРАВ ВЫПРЯМИТ	RIGHT DC RECTIF FAILURE	Right rectifier failure
73	56	ЭЛЕКТРОН РЕГУЛЯТ ЛЕВ ДВ	LEFT ENG GOVERNOR	Left engine electronic engine governor failure
74	57	ЭЛЕКТРОН РЕГУЛЯТ ПРАВ ДВ	RIGHT ENG GOVERNOR	Right engine electronic engine governor failure
43	34	ОТКАЗ ЛТЦ-РЭП	CMD FAILURE	UV-26 flare dispenser failure
35	29	РАЗГЕРМ КАБИНЫ	LOW COCKPIT PRESS	Cockpit depressurization
76	59	НЕТ НАДДУВА ГИДРО	NO HYDRO PRESS	No hydraulic tanks boost pressure
36	29	ОТКАЗ СКВ	AIRCOND FAILURE	Cockpit air conditioning and ventilation system failure
37	30	ОТКАЗ ПОС ВИНТОВ	ROTOR ANTIICE FAILURE	Rotor anti-ice system failure
77	60	ПРЕДЕЛ ВИБРАЦИЯ ЛЕВ ДВ	HI VIBR LEFT ENG	Left engine critical vibrations



1. Pitch scale
2. Moving aircraft datum
3. Bank scale
4. Sideslip indicator (ball)
5. Warning flag
6. Cage/control test handle

Primary indications on the instrument include:

- Bank is indicated by the rotation of the aircraft datum in relation to the fixed bank scale. In clockwise rotation, right bank and the opposite for left. For bank reference, the scale has 5° step in the 0...30° range and further steps are at 15°. The indications for 30° and 60° bank angles are written on the scale.
- Pitch is indicated by the moving pitch scale in relation to the aircraft datum. When the scale moves down from the neutral (zero) position, a climb is indicated; if it goes up, a dive is indicated. The scale has marks for 5-10-15-20 with 5° steps. The digits 10-20-30-40-50-60-70 angles are written on the scale.

Sideslip is indicated by the moving ball inside the horizontal tube. When the ball moves left of the center (the space between the two vertical bars), right slip is indicated and conversely when the ball moves to the right.

After power has been supplied by the “**РЕЗЕРВ АГ**” (Standby Attitude Indicator power) switch, uncage gyro (release the handle) after 60 seconds. The time needed to align the axis with vertical is up to 30 seconds.

Cage/control test handle’s functions:

- To perform a test, press the handle
- Caging. Pull the handle. If necessary, set the handle in pulled position by rotating it clockwise. To do so with the mouse, place the cursor on the SAI handle and rotate the mouse wheel while holding down the right mouse button. While still rotating the mouse wheel, release the right mouse button.
- To set the pitch scale, rotate the handle

When the instrument is receiving power, the localizer/glideslope deviation bars will move outside the instrument field of view.

The red warning flag drops when the artificial horizon fails, when the indicator test is performed, or the gyro is caged.

The true horizon error can be due to the following factors:

- Constant and random gyro drift
- The Earth’s rotation
- The helicopter’s movement in relation to the Earth
- Drifts caused by mass unbalance – depends on the helicopter’s accelerations

Radial correction aligns the gyro's axis with 'imaginary' vertical. By 'imaginary' vertical we mean the vector sum of the gravity acceleration and all other accelerations of the helicopter. The radial correction is inactive when the angle between the total acceleration vector of the helicopter and the main gyro axis exceeds 8 degrees.

The gyro's drift ranges from 0 to 5 degrees per minute.

## Exhaust Gas Temperature Indicator

The exhaust gas temperature (EGT) indicator displays the exhaust gas temperature for each engine. The large scales measure temperature in hundreds of degrees centigrade and the two smaller scales provide more precise readings in tens of degrees.



### 2-25: Exhaust gas temperature indicator

1. "КОНТРОЛЬ Т ГАЗОВ ДВИГ РАБОТ" (Running engines exhaust gas temperature indicator test) button [LCTRL + P]. After the button is pressed, the indicator should indicate no more than 150°C.
2. "КОНТРОЛЬ Т ГАЗОВ ДВИГ НЕ РАБОТ" (Stopped engines exhaust gas temperature indicator test) button [LALT + P]. After the button is pressed, the indicator should indicate no more than 800°C.
3. The large scales measure temperature in hundreds of Celsius degrees.
4. The small scales measure temperature in tens of Celsius degrees.

Temperature readings should first be read from the large scale in hundreds of degrees and then from the small scale in tens of degrees.

## Tachometer

The tachometer indicates the RPM of each engine turbine. The scale is calibrated to display RPM as percentage of maximum. 100% is equivalent to 19,537 RPM. The gauge consists of two needles, one for each turbine. Note that this gauge does not require electrical power.



### 2-26: Engines RPM indicator

Takeoff mode – 97%

Normal flight – 95%

Cruise mode 1 – 93%

Cruise mode 2 – 92%

Idle – 72...78%

## Fuel Quantity Indicator

The fuel quantity indicator measures the remaining fuel in the front and rear tanks. The meter is demarcated from 0 to 800 kilograms.



### 2-27: Fuel quantity indicator

1. Rear tank needle



2. Forward tank needle
3. **"КОНТРОЛЬ ТОПЛИВОМЕРА"** (Self test fuel quantity indicator) button [P + LALT + LCTRL + LSHIFT]
4. **"П"** (Forward) and **"З"** (Rear) tank lights

Maximum fuel quantity in front tank is 705 kg and the rear tank is 745 kg.

Upon reaching the 110 kg minimum emergency threshold in either tank, the master warning light starts flashing, and the EKРАН systems displays the text, **"ПЕРЕДНИЙ БАК 110 КГ"** (for forward tank – 110 kg) or **"ЗАДНИЙ БАК 110 КГ"** (for rear tank – 110 kg).

With **"КОНТРОЛЬ ТОПЛИВОМЕРА"** (Self test fuel quantity indicator) button depressed, the fuel indicator needles will display the determined values from current remaining fuel and both tank lights illuminate.

## Caution Lights Panel



2-28: Caution light panel

## Left Forward Panel Caution Lamps

<b>Russian</b>	<b>English</b>	<b>Description</b>
<b>п ст ПРЕД ЛЕВ ДВИГ</b>	<b>LH ENG OVERSPD</b>	Left engine power turbine over-speed
<b>п ст ПРЕД ПРАВ ДВИГ</b>	<b>RH ENG OVERSPD</b>	Right engine power turbine over-speed
<b>п<sub>y</sub></b>	<b>OVER-G</b>	G over-limit
<b>ВИБРАЦИЯ ЛЕВ ДВИГ</b>	<b>LH ENG VIBR</b>	Left engine vibration exceeded
<b>ВИБРАЦИЯ ПРАВ ДВИГ</b>	<b>RH ENG VIBR</b>	Right engine vibration exceeded
<b>V<sub>max</sub> доп</b>	<b>IAS MAX</b>	Maximum allowed IAS exceeded
<b>ГЛАВ РЕД</b>	<b>MAIN GRBX</b>	Minimum main gearbox oil pressure  Main gearbox oil overheat  Oil metallic chip detected
<b>ПОЖАР</b>	<b>FIRE</b>	Left engine fire  Right engine fire  APU fire  Hydraulics bay fire  Main gearbox fire
<b>ОТКАЗ СРО</b>	<b>IFF FAIL</b>	IFF failure
<b>АТАКА БЕРЕГИСЬ</b>	<b>LASER WARNING</b>	Caution! Laser warning new threat is detected
<b>ВЫПУСТИ ШАССИ</b>	<b>EXTEND GEAR</b>	Extend landing gear

## Landing Gear Control Panel

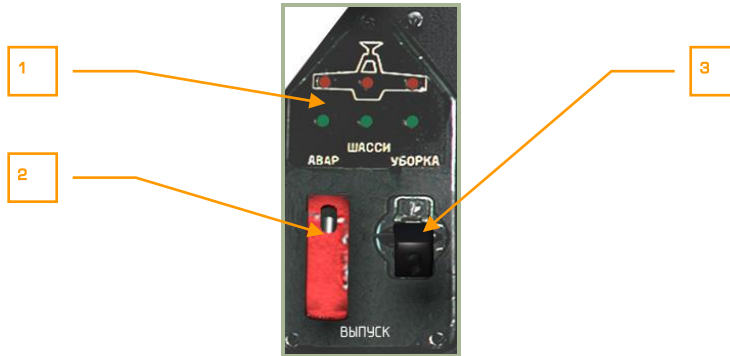

### 2-29: Gear control panel

1. **Gear position indicators.** Upper red lamps are ON when the gears are retracted. Lower green lamps indicate that gears are extended.
2. **Emergency gear hydraulics selector switch.** When in the upper position (default) position, the gears are controlled from the common hydraulics system. If the common system is damaged the main hydraulics system will be used for gear control. To do this, raise red protective cover [G + LCTRL] and move the switch in the lower position. [G + LALT]
3. **Raise/Extend gear lever.** This lever is the primary means of raising and lowering the landing gear and is powered by the common hydraulics system. [G]

## OVERHEAD PANEL



### 2-30: Overhead panel, left side

1. **Brightness switch for red, green and white wingtip and tail navigation lights.** This is a four position switch that can be cycled with each left button mouse click on the switch. Possible settings include off, 10%, 30% and 100% [L + RALT]. The fourth "АНО КОД" position (right mouse click) is a momentary position and is used to send visual 'coded' signals (Morse code for example) to other aircraft and ground units in the case of radio communication failure. [L + LALT].
2. **Windshield wiper switch.** This four position switch and three speeds and off positions). To return the wiper to the default position, press the "СТЕКЛОЧИСТ ВОЗВ ЩЕТКИ" (Wiper return) switch with a right mouse button click. [W + LALT + LCTRL]
3. **Windshield washer fluid switch,** No function
4. **Brightness adjustment knob,** No function
5. **Pitot static port and AoA sensors heat switch.** Placing this switch to the up position will warm the sensor and prevent ice from developing on it in cold conditions. Ice development can result in erroneous air speed indications. This switch is also used to control heating of the angle-of-attack (AoA) and side-slip vane sensors. [S + LALT + LSHIFT].
6. **Pitot ram air and clock heat switch.** Placing this switch to the up position will warm the sensor and prevent ice from developing on it in cold conditions. Ice development can result in erroneous air speed indications. This switch is also used to heat the onboard mechanical clock (otherwise, it may increase the rate of time error). [S + LCTRL + LSHIFT]
7. **Windshield heater switch.**

8. **Magnetic compass.** This is a standard, liquid-filled, back-up compass that requires no electrical power. See magnetic compass section below for more detail.

### Left Overhead Panel Warning and Advisory Lamps

Russian	English	Description
<b>Н рв СТАБ</b>	<b>R-ALT HOLD</b>	Radar altitude-hold autopilot mode is ON
<b>ВИСЕНИЕ</b>	<b>AUTO HOVER</b>	Hover autopilot mode is ON
<b>СНИЖЕН</b>	<b>AUTO DESCENT</b>	Controlled descent autopilot mode is ON
<b>МАРШРУТ ЗК</b>	<b>ENR NAV ON</b>	Route navigation with direct flight to steerpoint is enabled
<b>МАРШРУТ ЛЗП</b>	<b>ENR COURSE</b>	Route navigation with course following is enabled
<b>ППМ РАЗВОРОТ</b>	<b>NEXT WP</b>	Notification of passing one waypoint and advancing to the next
<b>КОНЕЦ МАРШРУТА</b>	<b>ENR END</b>	Last waypoint reached notification; end of flight plan
<b>СЧИСЛЕНИЕ ГРУБОЕ</b>	<b>AC-POS. CAL. DATA</b>	Aircraft position is roughly calculated using air data systems information
<b>ВЗРЫВ (red)</b>	<b>WEAP. ARM (red)</b>	Weapons armed
<b>ППУ</b>	<b>CANNON</b>	Cannon has been slewed away from boresight position
<b>ППУ ◊</b>	<b>CANNON ◊</b>	Cannon has been slewed downward away from boresight position, no function
<b>КОЛЬЦЕВ ОТКРЫТО</b>	<b>X-FEED VLV OPEN</b>	Fuel is shared between tanks (crossfeed on)
<b>МУФТА ОТКЛ</b>	<b>TURBO GEAR</b>	Accessory gearbox disconnected from rotor drive
<b>Р масла ПРИВОДОВ</b>	<b>AGB OIL PRESS</b>	Gearbox oil pressure normal (before start)
<b>ЗАМОК ОТКРЫТ</b>	<b>SL HOOK OPEN</b>	Sling load lock (hook) is open, no function



2-31: Overhead panel, right side

1. **Rotor de-icing system switch.** Placing this switch in the up position will warm the rotor blades to the point that it prevents icing. If ice does develop on the rotor blades, they will dramatically lose lift generating capability. It is always best to turn this on when operating in cold air. [S + LALT + LCTRL + LSHIFT]
2. **Engines de-icing/dust-protection systems switch.** To prevent ice from forming in the engine intakes, place this switch in the up position. This will warm the air intake manifolds and prevent ice from forming in cold conditions. If ice forms, the flow of air to the engines will be impeded. The system will also prevent dust build-up in dusty conditions. [I + LALT]
3. **Left/right pitot heat indicator lamp.** These lamps will be illuminated when the pitot heat control button is pressed and the pitot tube heat system is operating normally.
4. **Pitot heat test button.** Pressing this button will light the left/right pitot heat control lamps (if pitot heat is enabled).
5. **Cockpit ventilation fan switch,** No function

## Right Overhead Panel Message Lamps

Russian	English	Description
<b>БОЕВАЯ СЕТЬ ВКЛ</b>	<b>MASTER ARM ON</b>	Master ARM is on
<b>ТРЕНАЖ</b>	<b>WAEPON TRAINING</b>	Training mode for guided weapons is on
<b>ОБЗОР (yellow)</b>	<b>HMS FAIL (yellow)</b>	Helmet-Mounted Sight malfunction detected
<b>ПАНЕТ (yellow)</b>	<b>HUD NOT READY (yellow)</b>	HUD failure or not ready
<b>К-ЦВМ</b>	<b>COMPUTER DIAGNOSE</b>	Onboard computers running in diagnostic mode
<b>ЦВС (yellow)</b>	<b>COMPUTER FAIL (yellow)</b>	Failure of one or more central computers
<b>ПРЕОБРАЗ</b>	<b>INVERTER ON</b>	Electrical DC/AC inverter is on
<b>И-251В (yellow)</b>	<b>"SHKVAL" FAIL (yellow)</b>	Shkval targeting system failure detected
<b>ПОС ЛЕВ ДВИГ</b>	<b>LH ENG ANTI-ICE</b>	Left engine de-icing active
<b>ПЗУ ЛЕВ ДВИГ</b>	<b>LH ENG DUST-PROT</b>	Left engine dust protector is active
<b>ОГРАН РЕЖ ЛЕВ (yellow)</b>	<b>LH POWER SET LIM (yellow)</b>	LEFT ENG PWR LIMIT Left engine has over-speed and was limited by electronic engine governor
<b>ПОС ВИНТ</b>	<b>ROTOR ANTI ICE</b>	Rotor de-icing system is active
<b>ПОС ПРАВ ДВИГ</b>	<b>RH ENG ANTI-ICE</b>	Right engine de-icing is active
<b>ПЗУ ПРАВ ДВИГ</b>	<b>RH ENG DUST-PROT</b>	Right engine dust protector is active
<b>ОГРАН РЕЖ ПРАВ (yellow)</b>	<b>RH POWER SET LIM (yellow)</b>	RIGHT ENG PWR LIMIT Right engine has over-speed and was limited by electronic engine governor
<b>ОБОГРЕВ ВУО</b>	<b>WINDSHIELD HEATER ON</b>	Windshield heater is on
<b>БАК ПЕРЕДНИЙ</b>	<b>FWD TANK</b>	Forward fuel tank has pressure



	<b>PUMP ON</b>	
<b>КРАН ЛЕВ ЗАКРЫТ (yellow)</b>	<b>LH VLV CLOSED (yellow)</b>	Left engine fuel valve is closed
<b>БАК ЛЕВ ВНЕШН</b>	<b>LH OUTER TANK PUMP</b>	Left outer fuel tank has pressure
<b>БАК ЛЕВ ВНУТР</b>	<b>LH INNER TANK PUMP</b>	Left inner fuel tank has pressure
<b>БАК ЗАДНИЙ</b>	<b>AFT TANK PUMP ON</b>	Aft fuel tank has pressure
<b>КРАН ПРАВ ЗАКРЫТ</b>	<b>RH VLV CLOSED (yellow)</b>	Right engine fuel valve is closed
<b>БАК ПРАВ ВНЕШН</b>	<b>RH OUTER TANK PUMP</b>	Right outer fuel tank has pressure
<b>БАК ПРАВ ВНУТР</b>	<b>RH INNER TANK PUMP</b>	Right inner fuel tank has pressure



## PRTz Data Link Control Panel

The data link control panel is located on the left side of the overhead panel. It is integrated with the Weapons Control System (WCS) and its purpose is to send and receive information about targets on the battlefield to and from other flight members. The pilot can select a target type, exchange target data with other flight members, and assign targets and initial points to wingmen.

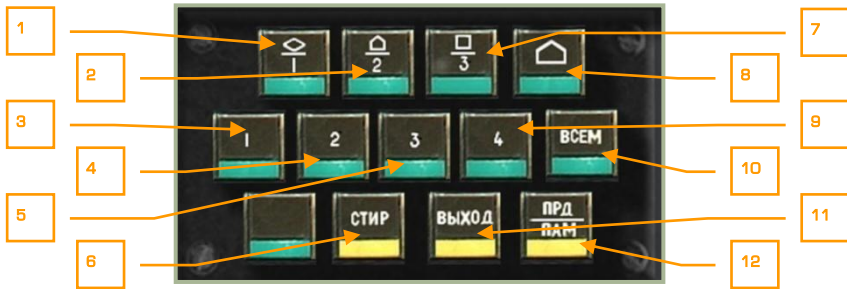

### 2-32: Data link control panel

The control panel consists of three rows of buttons that allow you to send and receive targeting information. Buttons include:

1. **DLINK target #1 as vehicle type.** Indicates the target to send or received from a wingman is a vehicle type of target. [1 + LSHIFT]
2. **DLINK target #2 as SAM or AAA type.** Indicates the target to send or received from a wingman is an air defense target. [2 + LSHIFT]
3. **DLINK to Wingman 1.** Elects to send the data link target to wingman 1. [1 + LCTRL]
4. **DLINK to Wingman 2.** Elects to send the data link target to wingman 2. [2 + LCTRL]
5. **DLINK to Wingman 3.** Elects to send the data link target to wingman 3. [3 + LCTRL]
6. **"СТИР" button:** Clear DLIN. After a target type and target receiver has been entered, this button can be pressed to clear the information. [T + LSHIFT]
7. **DLINK target #3 as type Other.** Indicates the target to send or received from a wingman is a target other than vehicle or air defense. [3 + LSHIFT]
8. **DLINK Initial point.** Like vehicles, air defenses and other, you may send and receive an initial point to and from wingmen via the data link. This can be useful for communicating a battle position or ambush point. [4 + LSHIFT]
9. **DLINK to Wingman 4.** Elects to send the data link target to wingman 4. [4 + LCTRL]



10. "**ВСЕМ**" button: DLINK to All. In addition to sending targeting information to a specific wingman, you may also press this button to send the data to the entire flight. [5 + LCTRL]
11. "**ВЫХОД**" button: DLINK automatic ingress to target. This button activates functionality to automatically point the aircraft in the direction of the assigned data linked target. [Y + LSHIFT]
12. "**ПРД/ПАМ**" button: DLINK send/memory. After you have selected the target type and a data link receiver, you may press this button to send the information over the data link. Additionally, when you receive data link data from another flight member, pressing this button will accept the data/assignment. [U + LSHIFT]

Please see the "Using Data Link" chapter to learn more about using the PRT panel in regards to employing the data link.

## Laser Warning Receiver (LWR)

The laser warning receiver (LWR) is located just below the PRT control panel and is capable of providing you warnings of laser energy that is illuminating your aircraft. This is particularly useful because main battle tanks and other combat ground vehicles will often use their laser range finders to input accurate target range data into their fire control systems before firing. A warning on the LWR is a sure indication that a ground vehicle or other helicopter is targeting you. To counter, you may wish to maneuver your aircraft (a still target is a dead target) and/or dispense flare countermeasures if you think an infrared-guided surface-to-air missile may have been launched. To best avoid being hit by a direct fire weapon like a tank gun round or an ATGM, make sure to not fly directly at the shooter. Instead, provide them a crossing target.

Note that tank crews of many armed forces are trained to use their main guns as an anti-helicopter weapon and will engage you if you are within 1,500 meters and present them a non-crossing target. Other vehicles, such as ATGM launchers, will also engage you but at even longer ranges. Additionally, many vehicles have secondary machine guns that they will use to engage you when in close range.

Prior to using the LWR, you must set the Laser Warning System (LWS) switch to on. This switch is located on the Auxiliary Control panel on the rear panel.

Use the LWR in conjunction with maneuvers to avoid threats; a still target is a dead target when in range of enemy weapons!



### 2-33: Laser warning receiver (LWR)

The LWR panel consists of the following elements:

1. **Incoming laser bearing indicator lamps.** These four red lamps indicate the relative direction that laser energy is being detected from. The top and bottom lamps represent detections in front and behind you and the lamps to the left and right indicate laser designation to the left and right. After a lamp has been lit, you will need to press the Reset LWR button to turn it off; the lamps will not automatically turn off once the illumination stops.
2. **Incoming laser hemisphere** (above/below). Depending on the target being above or below you, one of these two lights will be lit. If the upper light is on, it probably indicates that an enemy aircraft is designating you for an attack.
3. **Laser is in range-finding mode.** If this light is on, it indicates that the laser energy is of sufficient strength that the enemy weapon is probably in range of reaching you.
4. **Reset LWR button.** Pressing this button will reset any bearing, altitude hemisphere, and laser range and guidance lamps that are lit. [L]
5. **Laser is in guidance mode.** Some lasers modulate their frequency when actually guiding a weapon. If such a signal is detected, this lamp will light to indicate that a weapon is probably being guided towards you. This is most often the case with ATGM weapons.

## UV-26 Countermeasures Control Panel

The UV-26 countermeasures control panel is located to the right of the overhead panel and it is used to configure the release of infrared (IR) flare countermeasures. These are used as decoys against heat-seeking missiles like the Igla (SA-16), FIM-92 Stinger, AIM-9 Sidewinder, R-60 (AA-8 Aphid), and R-73 (AA-11 Archer). The goal of the flare release is to provide the IR missile seeker a more appealing target than your helicopter. The key to successful flare use can often be based on the range you start dispensing flares against

an incoming missile, the number and interval you release them in, and the aspect you keep your aircraft in relation to the released flares and the missile. The UV-26 allows you to program release modes to best fool an enemy IR seeker.

Note that flares will not have any affect on optical or radar guided missiles.

From the mission payload editor, you may select how may flares you wish to load on your helicopter.

To activate the UV-26 panel, you must first set the countermeasure system (CMS) power switch to on. This switch is located on the Auxiliary Control panel, next to the LWS power and test controls on the rear panel.



### 2-34: UV-26 Countermeasures control panel

The UV-26 panel has the following controls:

1. **Program display.** The digital read-out indicates the currently selected flare dispensing parameters. When the "НАЛИЧ-ПРОГР" switch is in the "НАЛИЧ" (quantity) position, the display shows the remaining quantity of flares (the Ka-50 can carry a maximum of 128). When in the "ПРОГР" (program) position, the first number indicates the "СЕРИЯ" (number of sequences), the second number indicates "ЗАЛП" (flares in sequence) and the third number shows the setting for "ИНТЕРВАЛ" (dispense interval).
2. **Dispenser side lamp** – Indication that flares will be dispensed from the left dispenser.
3. "БОРТ" (side) release select switch. This is a three position switch that can be set to the center position for release of flares from both sides; to the left for

release of flares from the left wing dispenser or to the right for release of flares just from the right wing. Depending on the selection, the appropriate lamp(s) will be visible in the display field above. [ ] + RALT]

4. "СЕРИЯ" button. Pressing this button cycles through the number of flare sequences options. The number of sequences is equal to the number of times the program will be run (except for 5 when the number of sequences is 12 and for 7 when the number of sequences is 15). When the value is set to 0, flares will be dispensed continuously. [INSERT + RSHIFT]
5. "ЗАЛП" (salvo) button. Press this button to cycle between the number of flares to be released in a single program sequence. Values range 1 through 8. [INSERT + RCTRL]
6. "СТОП" (stop) button. Stops the currently running program. [DELETE]
7. Lamp – Indication that flares will be dispensed from the right dispenser.
8. "НАЛИЧИЕ – ПРОГР" (quantity-program) switch. When set to "НАЛИЧИЕ", the display indicates the number of flares remaining; when set to "ПРОГР", it shows the current flare program numeric code. [ ] + RCTRL]
9. "ИНТЕРВАЛ" (interval) button. Pressing this button cycles between the time-delay between flare release settings. The delay is in seconds and is equal to the displayed number except for the cases of 7, 9 and 0, for which the intervals are 0.25, 0.5 and 0.125 seconds respectively. [INSERT + RALT]
10. "СБРОС ПРОГР" (reset program) button. This button resets the programmed parameters to the default, "110". [DELETE + RCTRL]
11. "ПУСК" (dispense) button. Pressing this button executes the configured flare dispersion program. [INSERT]

Example programs:

**110:** 1 sequence, dispense 1 flare, delay of 0.125s. Pressing "ПУСК" releases a single flare from the selected side pod (depending on the position of the "БОПТ" switch). This is the default program.

**622:** 6 sequences, 2 flares in a sequence, 2 second interval. Flares will be dispensed in pairs, one from each side or from one side only, again depending on the "БОПТ" switch position.

**529:** 12 sequences, 2 flares in a sequence, interval of 0.5 s between releases.

A user-programmable LUA script for controlling the UV-26 countermeasures control panel is located in the \Scripts\Aircrafts\Ka-50\Cockpit\Devices\_specs\UV\_26.lua file.

## Magnetic Compass

The magnetic compass is an autonomous, self-contained, direction-indicating instrument that does not require a power source. It serves as a backup to other navigation instruments.

Its operation is based on a magnet reacting to the Earth's magnetic field.

The scale is calibrated in 5-degree increments and has a numeric readout every 30 degrees. North and South are marked "0" и "180" respectively.



### 2-35: Magnetic compass

Compass features:

- Measurement of uncertainty is  $\pm 1^\circ$
- Compass "stickiness" – under  $1^\circ$
- Maximum dynamic error – under  $35^\circ$
- Time for scale to come to a rest – no more than 17 s
- Operating temperature range  $\pm 60^\circ\text{C}$

Note that the compass does not indicate true aircraft heading due to magnetic variation, or deviation end-dip error. Thus, appropriate corrections need to be applied when determining true heading.

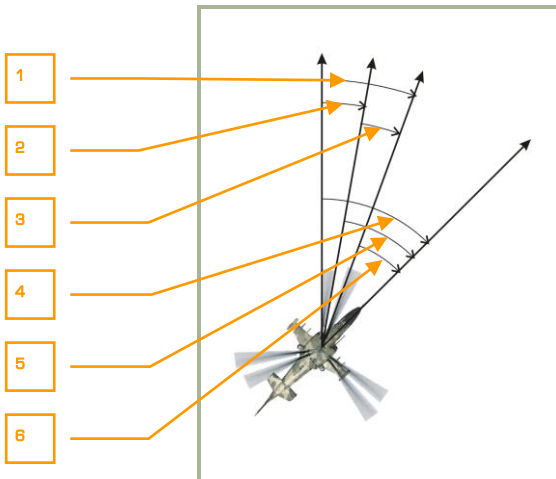

### 2-36: Aircraft course

1. Full variation
2. Magnetic variation
3. Deviation
4. True heading
5. Magnetic heading
6. Compass heading

In the Caucasus region where DCS: Black Shark takes place, the magnetic variation is approximately 5-degrees.

The compass deviation is caused by the helicopter's own magnetic field.

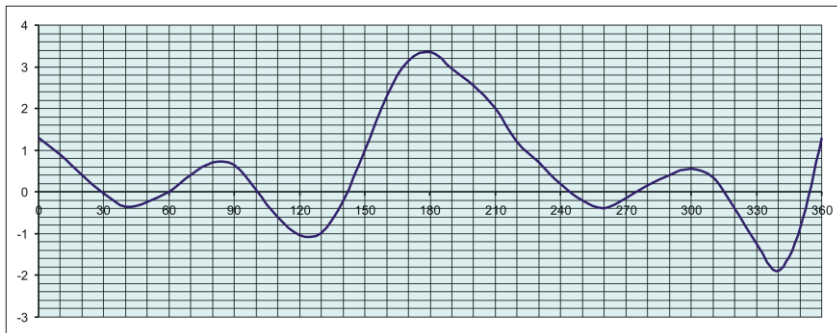

### 2-37: Compass deviation in Ka-50

Table above shows the compass deviation in our Ka-50 simulation.

- Y axis – deviation (in degrees)
- X axis – helicopter's compass heading

To find the current deviation, note the helicopter's compass heading on the X axis and then draw the vertical line parallel to the Y-axis. The intersection between the vertical line and the graph will indicate the value for deviation in degrees.

## CENTER PANEL

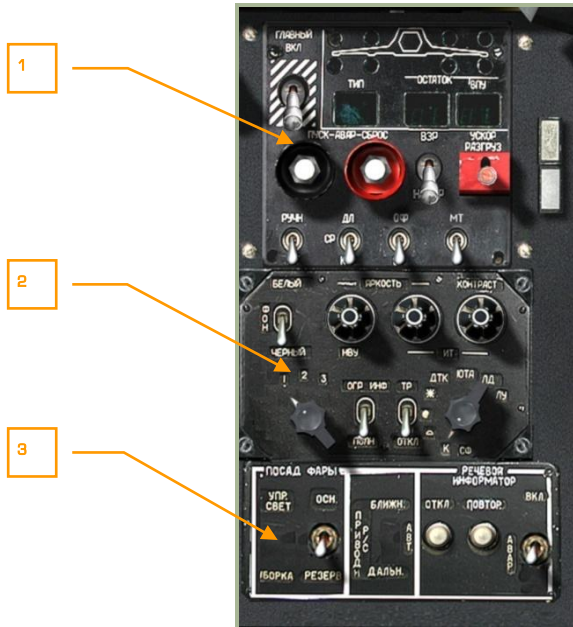

### 2-38: Center panel

The center panel is located in the lower center of the front dash and has its functions divided into three primary areas:

1. Weapon control panel
2. Targeting display control panel
3. Landing lights and voice warning ("Betty") control panel

Due to the position of the panel, you may need to move the cyclic out of the way or use keyboard commands to access the functions.



## PUI-800 Weapon Status and Control Panel

The weapon status and control panel is located at the top of the pedestal and it allows you to select the active weapon type, view weapon inventory and status, and control aspects of weapon employment.

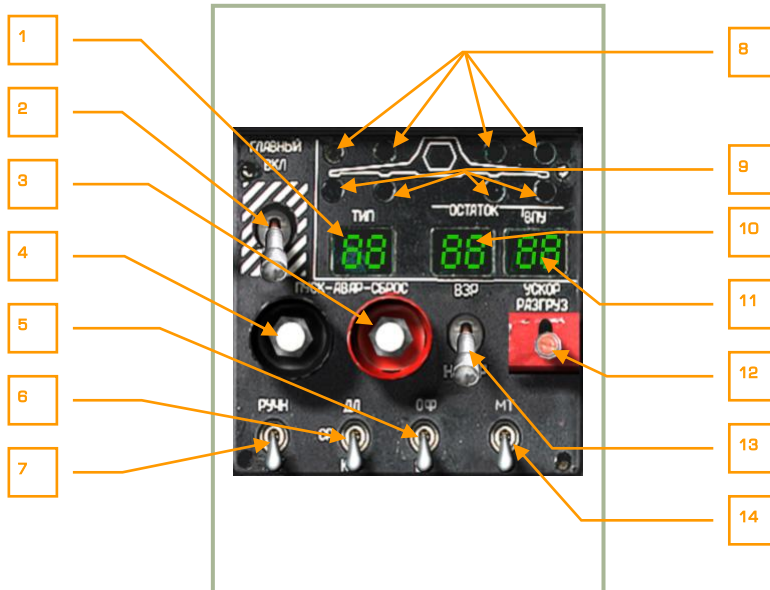

### 2-39: Weapon status and control panel

The weapons control panel has the following functions:

1. **"ТИП" (Store type)**. This field displays a two character indication of the selected store type: "НР" = rockets, "ПС" = anti-tank missiles, "АБ" = bombs, "ПБ" = external fuel tanks.
2. **"ГЛАВНЫЙ" (Master arm switch)**. Master arm is set to on when the switch is in the up position. When in the down position, all weapons are safe and weapons may not be employed. [W + LALT]
3. **"АВАР СБРОС" (Emergency launch button)**. Used to jettison all external stores except "Vikhr" ATGM. [R + LALT]
4. **"АВАР ПУСК"**. Emergency jettison of AA missiles. No function.
5. **"ОФ-БР" (HE-API cannon round selector switch)**. The 2A42 30mm cannon is fed belts of high explosive and armor-piercing rounds. You may select between the two with this switch: "ОФ" = high-explosive (HE), "БР" = armor-piercing incendiary (API). [C + LCTRL]
6. **"ДЛ-СР-КР" (Long-medium-short weapon mode switch)**. The 2A42 cannon has three firing modes: long burst "ДЛ", medium burst "СР", and short



burst "**KOP**". Use this three position switch to select the mode. This switch also controls rocket salvo amounts and if Vikhr is launched one at a time or in pairs. [S]

7. **"PY4H-ABT" (Manual/Auto weapon control switch)**. Placing this switch in the up "**PY4H**" position commands manual weapon and sensor control, and placing the switch in the down "**ABT**" position commands automatic control. When in manual mode, computed launch authorization, automated gate tracking size, and vertical compensation Vikhr launcher to target are absent. You should only use the manual mode when the automatic mode is inoperative. [A]
8. **Weapon readiness indicator**. The four green lamps represent each of the four under-wing hardpoints. When a store attached to a hardpoint is ready to fire, the green lamp over the station will light.
9. **Weapon presence indicator**. These four yellow lamps beneath each of the hardpoints represent a store being loaded on the station.
10. **Selected weapons remaining**. This field consists of two digits and displays the number of selected weapons (rockets or Vikhr) remaining.
11. **Cannon rounds remaining**. This field displays the number of cannon rounds remaining according to the cannon round selector switch setting. This number is displayed in tens.
12. **ATGM jettison selector "YCKOP PA3ГPY3" switch**. When this switch is held down, all Vikhr ATGM will launch quickly off the launcher with no guidance. [W + RCTRL]
13. **"B3P – HE B3P" (Armed/Disarmed weapon jettison arming switch)**. This switch determines if the weapon will be armed prior to being jettisoned. "**B3P**" = armed, "**HE B3P**" = disarmed for jettison. [W + LALT + LSHIFT]
14. **"MT-БT" (Low-High cannon rate of fire (ROF) switch)**. The 30mm cannon has two rates of fire that can be selected with this switch: "**MT**" = low and "**БT**" = high. [C + LSHIFT]

## Targeting Display Control Panel

Located directly below the weapon control panel, this panel controls how data is displayed on the different targeting and navigation displays.



### 2-40: Targeting display control panel

The targeting display control panel has the following functions:

1. **"ЯРКОСТЬ НВУ" (HMS Brightness control knob).** This knob can be rotated to control the brightness of the night vision goggles and Helmet Mounted Sight (HMS) reticle. This knob may be rotated up [I + RALT + RCTRL + RSHIFT] and down. [I + RALT + RCTRL + RSHIFT]
2. **"ФОН БЕЛЫЙ – ЧЕРНЫЙ" (Shkval polarity switch).** Using this switch, you may display either "БЕЛЫЙ" = white indication or "ЧЕРНЫЙ" = black indication on the Shkval display. [B + RCTRL + RSHIFT]
3. **"ОГР ИНФО – ПОЛН" (HUD declutter switch).** Use this switch to remove non-essential symbology from the heads up display: "ОГР ИНФ" = declutter, "ПОЛН" = full data. [S + RCTRL]
4. **Laser code selector.** The rotary dial has three positions and can be used to select the laser code that the Shkval will use when laser illuminating a target. This dial can be rotated left [I + RALT + RCTRL + RSHIFT] and right. [O + RALT + RCTRL + RSHIFT]
5. **"ЯРКОСТЬ ИТ" (TV display brightness knob).** Rotate this knob left [I + RALT + RCTRL] and right [I + RALT + RCTRL] to adjust the brightness of the Shkval TV display.
6. **"КОНТРАСТ ИТ" (TV display contrast knob).** Rotate this knob left [I + RCTRL + RSHIFT] and right [I + RCTRL + RSHIFT] to adjust the contrast of the "Shkval" TV display.
7. **"ТР – ОТКЛ" (Tracer switch).** No function.

8. "СФ", "К", "☰", "●", "✱", etc. color optic filters dial. This dial adjusts the Shkval optics for various weather conditions. No function.

## Landing Lights and Voice Warning ("Betty") Control Panel

The landing and voice warning ("Betty") control panel is located in the lower part of the center panel. It controls landing lights, navigation channels, and the automatic voice message unit (VMU). The landing lights are used to illuminate the landing position in the absence of lighting on the ground. The landing lights are located underneath the fuselage and can be slewed.



**2-41: Landing lights and voice warning ("Betty") control panel.**

The lights and VMU panel contains the following functions:

1. **"ОСН-РЕЗЕРВ"** (Main and backup landing light switch). To select either the main or backup landing lights, set this switch to the **"ОСН"** position to turn on the main landing light or select the **"РЕЗЕРВ"** position to select the backup light. [L + RCTRL]

Note that both lights can also be controlled via the **"ПОСАД ФАРЫ"** switch on the collective, independent of the **"ОСН-РЕЗЕРВ"** switch position. Additionally, you may slew the main landing light by holding down the right control key and pressing [;], [,] and [/]

2. **"УПР. СВЕТ – УБОРКА"** (Landing light ON/OFF switch). This is a three-position switch that controls the main landing light. The **"УПР СВЕТ"** extends the light and turns it on; the middle position turns the light off, and the **"УБОРКА"** position will turn off the light and retract it. [L + RSHIFT]
3. **"ПРИВОД Р/С. БЛИЖН-АВТ-ДАЛЬН"** (NDB's INNER-AUTO-OUTER beacon mode switch). The Non-Directional Beacon (NDB) mode switch has three positions and is used to select the ADF channel. **"ДАЛЬН"** (Outer) selects a navigation mode referenced to an outer airfield beacon while the **"БЛИЖН"** (Inner) setting is for navigation to the inner airfield beacon. The **"АВТ"** (Auto) mode automatically switches from outer to inner modes as the beacon is approached. [= + LALT]



4. **“РЕЧЕВОЙ ИНФОРМАТОР ОТКЛ”** (VMU cease message button). The **“ОТКЛ”** (OFF) button ceases current voice messages. [V + LSHIFT + LALT]
5. **“РЕЧЕВОЙ ИНФОРМАТОР ПОВТОР”** (Repeat VMU message button). This button initiates a replay of the active failures messages. [V + LALT]
6. **“ВКЛ – АВАР”** (On-Emergency) switch. **“ВКЛ”** is normal mode and **“АВАР”** is emergency mode with doubling all EKRAN messages with VMS sound. [V + LCTRL]

## WALL PANEL, FORWARD SECTION

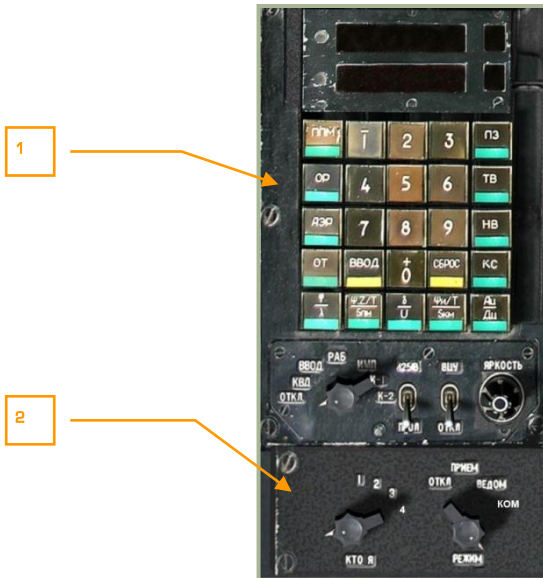

### 2-42: Wall panel, forward section

1. PVI-800 navigation control panel
2. PVTz-800 off-board targeting data link mode panel

## PVI-800 Navigation Control Panel

The PVI-800 works in parallel with the ABRIS navigation system, but whereas the ABRIS uses satellite navigation system inputs, the PVI-800 uses data from the Inertial Navigation Unit (INU).

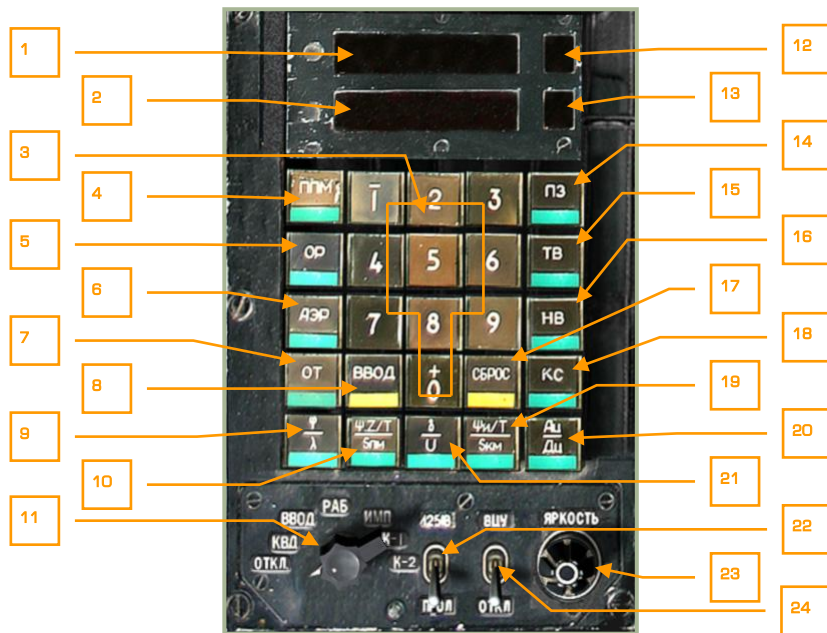

### 2-43: PVI-800 panel

1. Upper display window
2. Lower display window
3. Keypad [0 – 9 + RALT]
4. “ППМ” (Waypoint mode) button. To select a waypoint from the flight plan, press this modal button (the button will light) and then press the button of the desired waypoint from the keypad. Upon selection, the waypoint will become the steerpoint. The PVI-800 can store up to the six waypoints. When in “ППМ” mode, the upper window will display the latitude coordinate and the lower window will display the longitude coordinate. The selected waypoint number will be displayed in the waypoint window. Note that waypoint steering information displayed on the HUD will be from the PVI-800 and not the ABRIS. [Q + RALT]



5. **"OP"** (Reference point update) button. Used to select a reference point for an INU update. Up to four INU reference points can be set in the mission editor. **[E + RALT]**.



6. **"A3P"** (Airfield) button. This mode is used to select an airfield for RTB mode and it displays the coordinates of one of two airfields. In the simulation, airfield 1 will be your takeoff location and airfield 2 will be your landing location. If no landing or takeoff location is specified in the mission editor, this function will do nothing. **[T + RALT]**



7. **"OT"** (Target point) button. This mode is used to select a Target Point (TP) for ingress and entering coordinates for new TPs. Up to 10 TPs can be saved. TPs can be defined either as a fly over location, or with a Shkval lock. **[U + RALT]**





8. **"ВВОД"** (Enter) button. Used for the entering of data [I + RALT].
9. **"φ/λ"** (Own aircraft coordinates) button. Displays ownship coordinates. [A + RALT]

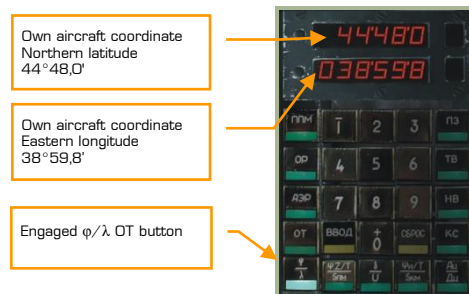

10. **"Ψ:Z/T/Snm"** button. Indication of DTA (DH sub-mode) or XTE (DT sub-mode), time and distance to current waypoint in the Waypoint, Reference, Airfield, and Target navigation modes. [S + RALT]

DH sub-mode indication:



DT sub-mode indication:



11. PVI Master Mode selector can be rotated left [V + RALT] and right [B + RALT]:

- "ОТКЛ" = Powers the PVI-800 off.
- "КВД" = Verification of entered data. This mode allows you to check a waypoint's coordinate and other data without changing the active navigation mode or steerpoint.
- "ВВОД" = Edit waypoint. This function allows you to enter waypoint coordinates, wind conditions, and other data. To do so:
  - Select EDIT
  - Press "ППМ" and the small upper window will display the total number of waypoints currently stored.
  - Press 1 – 6 on the keypad to select the desired waypoint number and the current waypoint coordinates will be displayed.
  - Using the keypad, enter new coordinates for the selected waypoint. Note that you should indicate N/S or E/W prior to entering the coordinate. To make the coordinate positive, press the 0 key first; to make the coordinate negative, press the 1 key first. When set to negative, a "-" symbol will appear left of the coordinate.
  - After the coordinate has been entered, press the ENTER button. Or, you may press CANCEL to clear the data on the display.
- "РАБ" = OPER (normal operation)
- "ИМП" = Simulated flight. This mode will simulate the entered flight plan with a simulated ground speed of 1,000 km/h. This can be used to check all bearings, ranges, tracks, and other data prior to flight.
- "К-1", "К-2" = Non-functional programming modes.

12. Waypoint display

13. Airfield number, fixed point, target point, or correction point display.

14. **"ПЗ"** (Rerun) button. Inertial navigation unit (INU) for in-flight realignment. No function.
15. **"ТВ"** (Precise alignment) button. INU precise alignment. This will align the INS gyrocompass and provide the most precise alignment with the heading finding function. This alignment takes about 30 minutes to complete. [R + RALT]
16. **"НВ"** (Normal alignment) button. INU normal alignment. [Y + RALT]
17. **"СБРОС"** (Reset) button. Press this button to remove data entered when in EDIT mode. [O + RALT]
18. **"КС"** (Initial point coordinates) button. Pressing this button will display your initial coordinate point and allow you to enter a new one. By default, the initial point coordinate comes from the mission editor. In this case, the initial point (KC) and own aircraft (" $\Phi/\lambda$ ") coordinates will similar. [P + RALT]

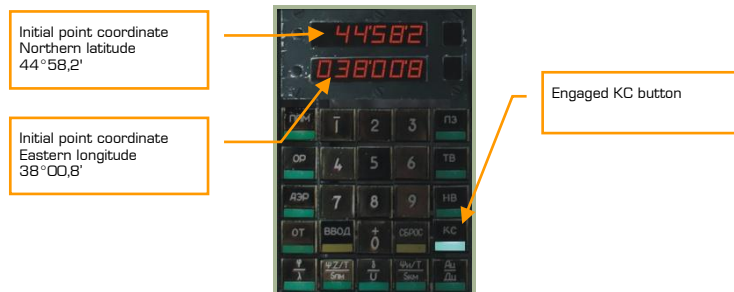

19. **" $\Psi$ и/Т/Скм"** (True heading/time/distance) button. Indication of true heading, time, and distance to final waypoint in the Waypoint, reference, airfield, and target modes. [F + RALT]



20. **"Ац/Дц"** (Heading/range to target point) button. Indication of heading and range to target in the Ingress mode. [G + RALT]



21. "δ/V" (Wind direction/speed) button. Indication of the wind direction and wind speed. Used meteo wind direction (from) that differs on the 180° degrees from navigation wind (to). [D + RALT]



22. "И-251В - ПРОЛ" (I-251V Shkval – Fly over INU update) switch. Mode of operation for INU correction. When set to "И-251В", INU coordinates will be corrected using the Shkval optics. When set to "ПРОЛ", the coordinates will be corrected by over-flying a reference point. [V + RCTRL]
23. "ЯРКОСТЬ" (Brightness) knob. Adjust panel backlighting brightness. Increase brightness [P + RSHIFT + RCTRL] and decrease brightness [[P + RSHIFT + RALT]].
24. "ВЦУ - ОТКЛ" (Data link – Off) switch. Off-board targeting data link power ON-OFF, respectively. [B + RCTRL]

**PVI navigation indication form**

Param	Display window	Sign	Digits						Range	Comments
			1	2	3	4	5	6	Units	
φ	Upper	±	Degrees			Minutes		Decimals	±0...75°	Indication during FLIGHT mode with engaged φ/λ button (9)
			Tens	Units '	Tens	Units '				
λ	Lower	±	Degrees			Minutes		Decimals	±0...180°	
			Hundreds	Tens	Units '	Tens	Units '			
ψ:Z/T	Upper	±	Degrees			Minutes of time			0...360° ±0...99.9k M	Indication during ROUTE, RETURN, INGRESS modes with engaged ψ:Z/T / Snm button (10) ψ – in DH mode; Z – in DTA mode («+» XTE right, «-» XTE left).
			Hundreds	Tens	Units '					
			Kilometers			Hundreds	Tens	Units		
S nm	Lower	±	Kilometers					0...999.9 km	* Indication with time remainder less 10 minutes.	
			Hundreds	Tens	Units '	Decimals				
ψ/T	Upper	±	Degrees			Minutes of time			0...360°	Indication during ROUTE, RETURN, INGRESS modes with engaged ψw/T / S km button (19)
			Hundreds	Tens	Units '	Hundreds	Tens	Units		
S km	Lower	±	Kilometers			Decimals		0...999.9 km	* Indication with time remainder less 10 minutes.	
			Hundreds	Tens	Units '					
δ	Upper	±	Degrees						0...360°	Indication during FLIGHT mode with engaged δ/V button (21)
			Hundreds	Tens	Units '					
V	Lower	±	Meters per second						0...50 m/s	
			Tens	Units						
Aц	Upper	±	Degrees						0...360°	Indication during FLIGHT mode with engaged Aц/Aц button (20)
			Hundreds	Tens	Units '					
Дц	Lower	±	Kilometers			Decimal		0...999.9 km		
			Hundreds	Tens	Units '					

## PVTz-800 Off-Board Targeting Data Link Mode Panel

This panel is located directly below the PVI-800 navigation control panel described above. The function of the PVTz-800 is to manage ownship data link identification and send-receive mode.



### 2-44: PVTz-800 off-board targeting data link mode panel

The PVTz-800 data link panel allows you to set your data link identification number and the manner in which you send and receive information with your flight members over the data link (maximum of four aircraft per data link group). Please reference the ABRIS section of this manual to learn how data link information is visually presented to you.

In a multiplayer mission, it is possible to have multiple data link groups in the mission at the same time; however, each would have to be on a different frequency.

The data link panel consists of two dials, the "**КТО Я**" dial and the "**РЕЖИМ**" dial.

The "**КТО Я**" (my ID number) dial, can be set 1 through 4 and allows you to set your own data link identification number. Each flight member should be assigned a unique ID number and the flight leader should be assigned ID 1. [\[I + LCTRL\]](#)

The "**РЕЖИМ**" (data mode) dial, allows you to select one of four options regarding how you receive and pass data link information to the rest of your flight. [\[M + LCTRL\]](#) The options include:

1. "**ОТКЛ**" (Disable) disables data link communication with your flight.
2. "**ПРИЕМ**" (Receive) is a receive data only mode (you cannot send data) and it is a secure mode that is difficult to detect by enemy electronic emission detection systems.
3. "**ВЕДОМ**" (Wingman) mode allows you to send and receive information from other flight members including the flight lead (ID 1). Wingman icons will be displayed on the ABRIS.
4. "**КОМ**" (Commander) mode allows you to send and receive information from just the flight leader. Wingman icons will be displayed on the ABRIS.

For more information about sending and receiving data link information, please consult the earlier PRT Data Link Control Panel chapter in this manual.

## RIGHT PANEL, MIDDLE SECTION

This panel is located under the pilot's right arm:

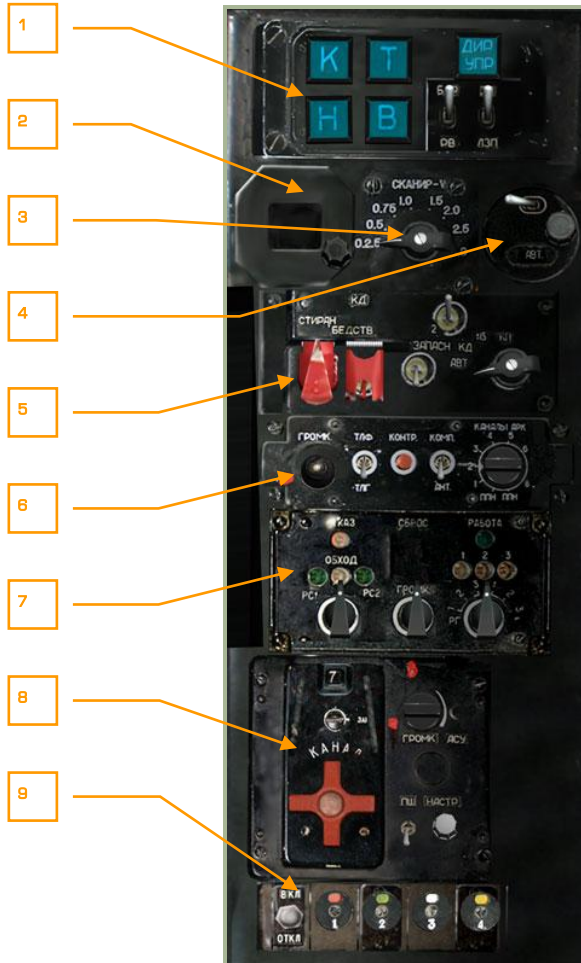

**2-45: Right panel, middle section**

1. Autopilot panel. See Autopilot Panel section
2. Magnetic variation panel. This panel displays the magnetic variation as inputted by the control knob below it. For the Caucasus region, the magnetic variation value is about 5-degrees.

3. Shkval optics scan rate. When placed in automatic scan mode, this dial can be adjusted to control the speed at which the Shkval scans side to side. Increase scan rate [M + LCTRL + LSHIFT] or decrease rate [M + LCTRL + RALT].
4. Latitude correction. Depending on what latitude hemisphere the helicopter is operating in, this switch and knob allow the operator to adjust needed latitude navigation compensation.
5. Identify-Friend-or-Foe (IFF) transponder control, No function
6. Automatic direction finder. See ADF ARK-22 section.
7. Special uplink control, No function
8. R-828 army radio system panel. See R-828 Control Panel section.
9. Signal flares control. See Signal Flare Panel section.

## Autopilot Panel

The autopilot system serves two primary functions. First it can act as a stability augmentation system and second it can be used in conjunction with several automatic flight modes.



### 2-46: Autopilot panel

1. **T** – Pitch dampener - Pitch hold. Enables pitch autopilot channel. [P + LSHIFT]
2. **K** – Bank dampener - Bank hold. Enables bank autopilot channel. [B + LSHIFT]
3. **H** – Lateral dampener - Heading/course hold. Enables lateral autopilot channel. [H + LSHIFT]
4. **B** – Altitude hold. Enables altitude hold. The altitude source depends on the position of the “**БАР - РВ**” (Baro – Radar altitude) switch. [A + LSHIFT]
5. “**ДИР УПР**” – Flight director mode button. Disengages autopilot automatic angular stabilization (except for dampener function) and enables flight director mode on the HUD. [A + LCTRL]
6. “**БАР-РВ**” (Baro – Radar altitude) Autopilot altitude hold data source selection [X + LCTRL]



"БАР" – by pressure altimeter  
"РВ" – by radar altimeter

- "ЗК-ЛЗП" (Desired Heading – Desired Track Angle) Autopilot Heading/Course hold mode [X + LALT]:  
"ЗК" – desired heading hold  
"ЛЗП" – desired track angle hold

## Automatic Direction Finder (ADF) ARK-22

The ARK-22 ADF controls the Radio Magnetic Indicator (RMI) needle on the Horizontal Situation Indicator (HSI), pointing it in the direction of the transmitting signal. Using the ADF, you can select one of eight preset channels, each of which stores two radio frequencies. Upon reaching the transmitter of the currently selected frequency, the ADF automatically begins homing on the second and vice versa. Alternatively, you can manually select which of the two frequencies on the selected channel to home on. For example, the first frequency in a given ADF channel may be set to home on the airfield outer locator beacon and the second on the inner locator beacon, etc. The pilot can verify selection of the correct beacon by configuring the ADF to provide an audio transmission of the beacon's ID. While in real life the frequencies for each ADF channel are set by ground personnel, you can edit these in the ADF configuration files outside the simulation.

The ARK-22 ADF can also be slaved to the R-800L1 VHF radio. In this case, the RMI needle on the HSI is directed toward the transmitter on the frequency currently selected for the R-800L1 radio. For example, the flight leader can maintain bearing to his wingman when the wingman is transmitting a radio call.



### 2-47: ADF panel

The ADF panel is powered-on when either "K-041" is turned on or when the "ПНК" navigation system on/off switch is turned on (right side panel).

- "КОНТР" (Test) self test button. When pressed, the bearing to radio beacon arrow on the HSI rotates to a set angle. When pressed in "АНТ" (antennae) mode, a continuous tone is emitted. Note that the "УКВ-1" VHF-1 R-828 radio switch and "УКВ-2" VHF-2 R-800 radio switch on the right panel should be set to on (up). [T + LALT + LCTRL]
- "ТЛГ-ТЛФ" (Telegraph-Telephone) mode switch. Non-directed beacon (NDB) can transmit in two modes, "ТЛГ" or "ТЛФ". In this simulation, all beacons transmit in the "ТЛГ" mode (switch in the down position). [J + LALT + LCTRL]



3. **“ГРОМК”** (Volume) volume control. Rotating this knob left [= + LALT + LCTRL] and right [- + LALT + LCTRL] controls the volume of the NDB audio signal code and the self test tone.
4. **“АНТ-КОМП”** (Antenna – Compass) ADF mode switch. This switch allows you to select either **“АНТ”** antenna mode or **“КОМП”** compass mode. When in **“АНТ”** mode, the ADF provides you the NDB audio signal as a Morse code. When in the **“КОМП”** mode, the ADF provides you RMI steering data on your HSI and ABRIS HSI. [[ + LALT + LCTRL]
5. **“КАНАЛЫ АРК”** (ADF channels) compass channel dial. This dial has 10 positions, any of which allow you to tune the ADF to a pre-configured NDB pair (**“ДАЛЬНИЙ – БЛИЖНИЙ”**, Outer-Inner beacons). A list of these preconfigured channels can be seen on the white sheet attached to the right wall of the cockpit. You can select between inner and outer beacons by use of the beacon mode switch on the landing and voice message panel. The two service channels (positions 9 and 0) are used for preliminary setup by ground crew. The channels can be selected by turning the dial to the left [= + LCTRL] and right. [- + LCTRL]

ADF in conjunction with ground-based non-direction beacons (NDBs) is an angle-measuring, radio-navigation system that provides you direction towards an active radio transmitter in the VHF frequency range. Each frequency has its own unique callsign or commands transmitted on it. ADF allows the following navigation tasks:

- Flight towards an NDB with visual indication of course angle (bearing)
- Landing approach in **“ОСП”** mode (ICAO 2NDB Approach) in conjunction with other indicators
- Continuous calculation and display of bearing
- Audio reception of NDB callsign tones

Bearing to NDB is indicated on the HSI and on the HSI ABRIS page based on bearing to radio beacon RMI arrow position. To display bearing on ABRIS HSI page, you first need to set the ADF signal source for RMI-1 or RMI-2. To do this, go to the ABRIS MENU page and select OPTIONS. Scroll down the list of options and select RMI-1 or RMI-2, and using the CHANGE button, set the ADF's source to RADIO. On the ABRIS HSI and ARC pages, the corresponding RMI-1 (2) RADIO arrow will now show course angle similar to the RMI arrow on the HSI.

The ADF works as a classic, automatic VHF NDB receiver. The signal emitted by the NDB is received simultaneously by non-directed and a directed stationary frame antennas. The signal from these antennas is transformed, (frequency selection, amplification, and detection) and then phase compared. As a result, a signal is created that corresponds to the bearing misalignment. This signal then drives an electromotor (with gearbox) that moves the directional pattern of the fixed frame antenna until the directional pattern receives a minimum signal to align with the NDB's location (bearing). The rotation of the directional pattern is transmitted electrically and rotates the RMI needle of the HSI and the ABRIS HSI (RADIO caret) to indicate the current NDB bearing.

ADF modes:

- **КОМПАС (КОМП)** – compass mode

- **АНТЕННА (АНТ)** – receiving audio signals from non-directional antenna
- **КОНТРОЛЬ** – ADF self test

ADF operating parameters:

- Frequency range from 150 to 1750 kHz
- 16 channels
- Frequency adjustment step – 0.5 kHz
- Bearing calculation uncertainty  $\pm 1.5^\circ$
- Indication speed no less than 30 deg/sec
- Time to switch between channels no more than 2.5 sec

The initial ADF channel setup is performed by the ground crew from the initial setup panel located at the rear of helicopter. In the game, you may alter the initial setup by editing the following file: BS\Scripts\Plane\Cockpit\Ka-50\ARK\ARK.lua. The default channels are listed on the white sheet of paper attached to the right wall of the cockpit.

In-flight ADF use should be used according to the flight plan or as a backup navigation system in the event of ABRIS failure. The channels can be changed using the **“КАНАЛЫ АРК”** switch or the **“ДАЛЬН-БЛИЖН”** (Outer-Inner beacons) switch on the central pedestal panel (lights and voice message unit control panel).

To hear the audio signal from an NDB radio station, set the **“КОМП-АНТ”** switch to **“АНТ”**. Volume can be adjusted using the volume adjustment knob on the ADF panel.

To select NDB data from ABRIS, you should do the following: on the MAP page, go to INFO and select the desired radio station and press INFO again. Radio station information will be displayed including type, name, frequency, callsign, Morse code coordinates and magnetic deviation. The sound signal should correspond to its Morse code.

#### Pre-set ADF channels

Channel	ДАЛЬНИЙ – БЛИЖНИЙ, (Outer-Inner knob position)	Object	Type	Callsign	Freq. KHz
1	ДАЛЬН	Krasnodar-Center	Outer NDB	OyO; MB	625.0
1	БЛИЖН	Krasnodar-Center	Outer NDB	O; M	303.0
2	ДАЛЬН	Majkop-Hanskaya	Outer NDB	DG; RK	288.0
2	БЛИЖН	Majkop-Hanskaya	Outer NDB	D; R	591.0
3	ДАЛЬН	Krymsk	Outer NDB	KW; YuO	408.0



3	БЛИЖН	Krymsk	Inner NDB	K; O	830.0
4	ДАЛЬН	Anapa-Vityazevo	Outer NDB	AN; AP	443.0
4	БЛИЖН	Anapa-Vityazevo	Inner NDB	N; P	215.0
5	ДАЛЬН	Sochi-Adler	Outer NDB	SO, AD	741.0
5	БЛИЖН	Sochi-Adler	Inner NDB	A	365.0
6	ДАЛЬН	Nalchik	Outer NDB	NL	718.0
6	БЛИЖН	Nalchik	Outer NDB	N	350.0
7	ДАЛЬН	Mineralniye Vody	Outer NDB	NR; MD	583.0
7	БЛИЖН	Mineralniye Vody	Inner NDB	N; M	283.0
8	ДАЛЬН	Kislovodsk	NDB	KW	995.0
8	БЛИЖН	Peredovaya	NDB	PR	1210.0

\\Scripts\Aircrafts\Ka-50\Cockpit\ARK\ARK.lua script for ADF

Aidroms list: \\Scripts\World\Aidromes.lua

Beacons list: \\Scripts\World\Radio\Beacons.lua

Troubleshooting for when an NDB signal is not received:

If the Morse code callsign is heard, check that the **“КОМП-АНТ”** switch is set it to the **“КОМП”** position (audio signal will be heard). The radio physics model calculates every transmission in real time and determines the local signal strength according to numerous variables, including time of day (ionosphere effect), surface type (rough terrain, paved surface, water, etc.), wavelength, range, transmitter power, etc. Because radio traffic is carried “live,” reception can be interrupted at any point by either natural or artificial interference, such as terrain topology or radio configuration. For example, if you change radio frequency, reception will cease, but can resume at its actual point upon reconfiguring the radio back to the transmitter’s frequency.

If the Morse code callsign cannot be heard, check the volume control knob **“ГРОМК”**, the channel selector and the **“ДАЛЬН-БЛИЖН”** selector. If all is set up properly, then the helicopter may be out of station range. If this happens, switch to another station in the vicinity.

## R-828 Radio Control Panel

The R-828 VHF radio is used for communication with a Forward Air Controller (FAC) and other ground force units. The system provides constant radio communication within line-of-sight and it does not require frequency searching and adjustment. The frequency range is 20 - 60 MHz.

The radio is turned on by setting the VHF-1 "YKB-1" switch to the up, on position. The switch is located on the right panel. The communications channel is set using the channel selection knob and the transmission is active when the selector VHF-1 "YKB-1" switch is on.

The control panel allows for:

- Switching between 10 channels that have been set in advance
- Volume control

Noise reduction when noise-reduction system is activated.

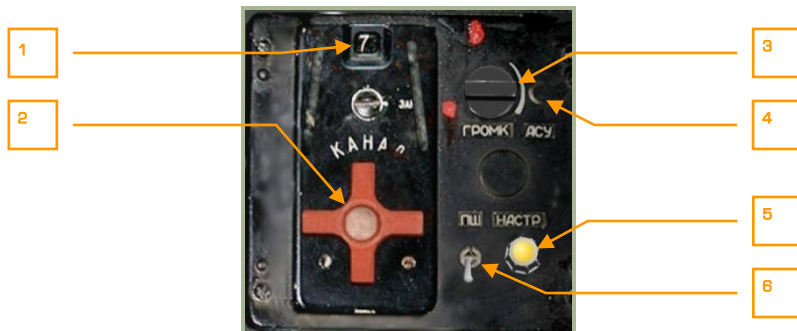

### 2-48: R-828 control panel

The R-828 control panel has the following functions:

1. **Selected channel ID.** The active radio channel selected via the channel selector wheel is displayed in this window. This can display 1 through 10.
2. **"КАНАЛ"** (Channel) selector. This red wheel can be rotated using left [M + RALT + RCTRL] and right [N + RALT + RCTRL] mouse clicks or keyboard input. The wheel cycles channels 1 through 10.
3. **"ГРОМКІ"** (Volume) radio volume control. Rotating this knob left [J + LCTRL + LSHIFT] and right [I + LCTRL + LSHIFT] adjusts the volume level of audio received over the R-828 radio.
4. **"АСУ"** (Automatic tuner) button. After you have selected a channel, you will need to press the tuner button to tune the radio to the selected channel. Every time you select a new channel, you will need to press this button. [T + RCTRL + RSHIFT]

5. “**HACTP**” (Tuner) automatic tuner indicator lamp. If the R-828 is under power and the automatic tuner button is pressed, this will light if the radio has not been tuned to the selected channel.
6. “**ПШ**” (Noise reduction system) switch (squelch). [R + RALT + RCTRL]

Once the required channel is set and you have pressed the “**ACY**” button, the system will tune to the selected channel’s frequency and the tuner indicator lamp will be lit. Once the tuning is complete, the lamp will turn off.

## Signal Flare Panel

The signal flares panel is used to control power to the signal flare system and fire the flares. The flares come in four colors: red, green, white, and yellow. A cassette with four flares is located at the edge of helicopter’s left wing.

Signal flares are most often used when radio systems have failed or when maintaining radio silence.



### 2-49: Signal flare control panel

1. Fire red flare button. [1 + LALT]
2. Power supply ON/OFF switch. Placing the switch in the up position provides power to the signal flare system. [0 + RCTRL]
3. Fire green flare button. [2 + LALT]
4. Fire white flare button. [3 + LALT]
5. Fire yellow flare button. [4 + LALT]

## WALL PANEL

The wall panel is located at the right side of the cockpit and includes several controls for electrical, radio, fuel, and emergency systems. Several of the switches have protective covers that need to be raised before the switch can be placed in the on, up position. When discussing the wall panel, we will divide it into the forward and aft sections.

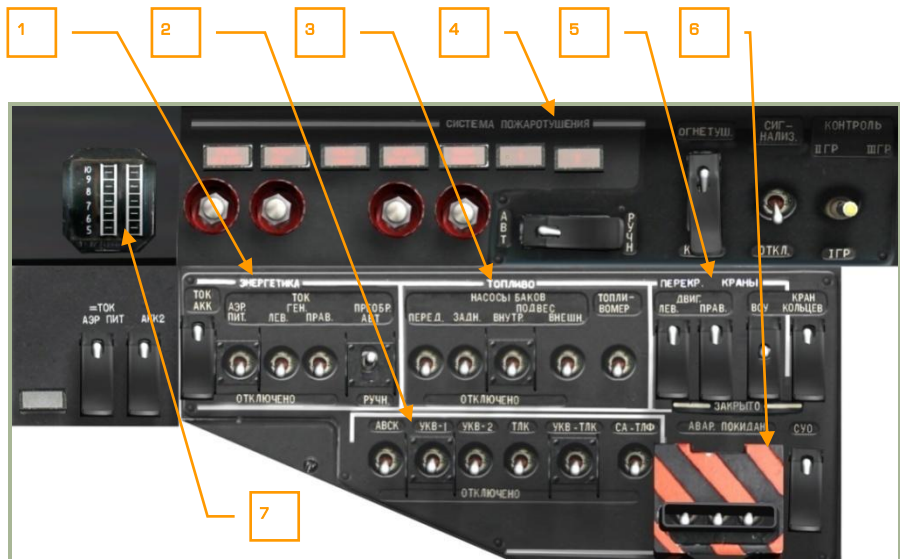

**2-50: Wall panel, forward section**

1. **“ЭНЕРГЕТИКА”** Electrical power controls
2. Radio and data link power controls
3. **“ТОПЛИВО”** Electrical fuel pumps power controls
4. **“СИСТЕМА ПОЖАРОТУШЕНИЯ”** Fire extinguishers control panel
5. **“ПЕРЕКР. КРАНЫ”** Fuel shutoff valves controls
6. **“АВАР. ПОКИДАН”** Pilot ejection system controls
7. Engine power indicator



**2-51: Wall panel, aft section**

1. Transmission and engine oil pressure and temperature gauges
2. Onboard equipment control
3. Lighting control
4. Electronic Engine Governors



## Electrical Power Controls



### 2-52: Electrical power controls

1. **"ТОК АКК"** (Battery 1) After flipping up the cover [E + LALT + LCTRL + LSHIFT] and selecting this switch [E + LCTRL + LSHIFT], electrical power will be drawn from battery 1. When performing a ground start with no ground power, you will need to set this switch to on in order to start the APU and engines.
2. **"ТОК АКК2"** (Battery 2). Enable this switch to draw electrical power from battery 2. This switch [W + LCTRL + LSHIFT] also has a cover. [W + LALT + LCTRL + LSHIFT]

Note: Enable both battery 1 and battery 2 for normal operations.

3. **"=ТОК АЭР ПИТ"** (Ground DC power). If on the ground at an airfield or FARP, you may radio ground maintenance to provide direct current (DC) ground electrical power. Before radioing though, be sure that the SPU-9 intercom dial is set to the **"НОП"** ground crew position. Once this order has been given, use this switch [Q + LCTRL + LSHIFT] to activate DC ground power to start the APU and engines. This switch also has a cover. [Q + LALT + LCTRL + LSHIFT]
4. **DC ground power source lamp**. When DC ground power is on, this lamp will be lit.
5. **"АЭР ПИТ"** (Ground AC power). If on the ground at an airfield or FARP, you may radio ground maintenance to provide alternating current (AC) ground electrical power. Before radioing though, be sure that the SPU-9 intercom dial is set to the **"НОП"** ground crew position. Once this order has been given, use this switch to activate AC ground power to start the APU and engines. [R + LCTRL + LSHIFT]
6. **"ТОК ГЕН. ЛЕВ."** (Left generator) switch. After the left engine is fully operating and the throttles are in automatic mode, you may turn on the left generator. This will supply power to the DC busses and onboard batteries. [Y + LCTRL + LSHIFT]
7. **"ПРЕОБР АВТ – РУЧН"** (Electrical power converter auto – manual) switch. This is a three-position switch that allows DC power to be converted to AC power that is required by several onboard systems. The up **"АВТ"** position

provides automatic conversion, the down "РУЧН" position requires manual conversion and the middle position turns off conversion. [I + LCTRL + LSHIFT]

8. "ТОК ГЕН. ПРАВ." (Right generator) switch. After the right engine is fully operating and the throttles are in automatic mode, you may turn on the right generator. This will supply power to the DC busses and onboard batteries. [U + LCTRL + LSHIFT]

## Radio and Data Link Power Control Panel



### 2-53: Radio and data link power control panel

This panel consists of seven switches that toggle power to the radio and data link systems on the aircraft. Prior to powering any of these systems, the aircraft will have to be supplied with AC power. These controls include:

1. "АВСК" (Intercom) switch. "АВСК" stands for Intercommunication and Radio Commutation system. This switch provides power to the SPU-9 intercom system. The SPU-9 provides simultaneous commutation with the R-800 radio, R-828 radio, ground intercom equipment, voice message system (VMS), and caution tones to pilot's headphones. [Z + LALT + LCTRL]
2. "УКВ-1" switch. VHF-1 R-828 radio power switch. [P + RALT + RCTRL]
3. "УКВ-2" switch. VHF-2 R-800 radio power switch. [P + LALT + LCTRL]
4. "ТЛК" switch. Data link equipment power switch. [O + LCTRL + LSHIFT]
5. "СА-ТЛФ" switch. Radio equipment data link SA-TLF switch. [P + LCTRL + LSHIFT]
6. "УКВ-ТЛК" switch. Data link equipment provides jam-resistant secure communications via VHF-TLK channel for remote target designation. [O + LCTRL + LSHIFT]

## Fuel Boost Pump Controls



### 2-54: Fuel pump controls

In addition to transferring fuel from the storage tanks to the engines using the suction force generated by operating engines, boost pumps are employed to provide uninterrupted flow and for APU and engine start. While the boost pumps need to be on for APU and engine start, they do not always need to be on once the engines are running; it is best though to always have at least the internal front and rear pumps active as long as the engines are operating.

The Ka-50 has two internal fuel tanks (forward and aft) and attachment points for two external fuel tanks on each stub-wing. Each fuel tank has a dedicated boost pump.

The fuel boost pump control panel has the following controls:

1. **"НАСОСЫ БАКОВ ЗАДН"** Aft fuel pumps. Toggles power to the aft fuel boost pumps. [D + LCTRL + LSHIFT]
2. **"НАСОСЫ БАКОВ ПЕРЕД"** Forward fuel pumps. Toggles power to the forward fuel boost pumps. [A + LCTRL + LSHIFT]
3. **"НАСОСЫ БАКОВ ПОДВЕС ВНУТР"** Inner stub-wing station external tank pumps. Toggles power to the two inboard stub-wing station pumps that can support external fuel tanks. [F + LCTRL + LSHIFT]
4. **"НАСОСЫ БАКОВ ПОДВЕС ВНЕШН"** Outer stub-wing station external tank pumps. Toggles power to the two outboard stub-wing station pumps that can support external fuel tanks. [G + LCTRL + LSHIFT]
5. **"ТОПЛИВОМЕР"** Fuel metering system ON/OFF power switch. [H + LCTRL + LSHIFT]

## Fire Extinguisher Control Panel

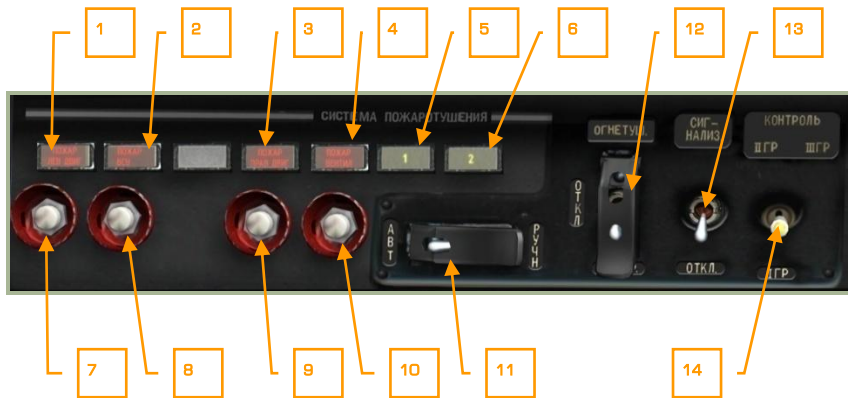

### 2-55: Fire extinguisher control panel

The Ka-50 has an extensive suite of fire monitoring and fire extinguisher systems that are controlled from the fire extinguisher panel. Each fire extinguisher system uses fire retardant contained within a pressurized bottle to flood the desired compartment. The fire extinguisher panel has the following functions:

1. **"ПОЖАР ЛЕВ ДВИГАТЕЛЯ"** (Left engine) fire lamp. This lamp indicates that a fire has been detected in the left engine bay.
2. **"ПОЖАР ВСУ"** (Auxiliary Power Unit (APU)) fire lamp. This lamp indicates that a fire has been detected in the APU bay.
3. **"ПОЖАР ПРАВ. ДВИГАТЕЛЯ"** (Right engine) fire lamp. This lamp indicates that a fire has been detected in the right engine bay.
4. **"ПОЖАР ВЕНТИЛ"** (Oil-coolers) fire lamp. If a high temperature has been detected in the oil-coolers compartment, this lamp will light.
5. **"1"** Automatic mode discharge lamp. If the **"БАЛЛОНЫ"** switch has been placed in the automatic, left, position, the fire extinguishers will automatically discharge when a fire has been detected. When in this mode, a "1" will be displayed on the lamp. Generally, keep the switch in the automatic position unless you want to fire the second extinguisher manually.
6. **"2"** Manual mode discharge lamp. When the **"БАЛЛОНЫ"** switch is in the right position, you will need to manually press one of the four fire extinguisher buttons to discharge in case of fire. When in the manual mode, a "2" will be displayed on this lamp.
7. **Discharge left engine fire extinguisher button.** Press this button when in manual mode to discharge the fire extinguisher to the left engine bay. [F + LSHIFT]

8. **Discharge APU fire extinguisher button.** Press this button when in manual mode to discharge the fire extinguisher to the APU bay. [F + LALT + LSHIFT]
9. **Discharge right engine fire extinguisher button.** Press this button when in manual mode to discharge the fire extinguisher to the right engine bay. [F + RSHIFT]
10. **Ventilator extinguisher.** Press this button when in manual mode to discharge the fire extinguisher to the oil-coolers compartment. [F + LALT + LCTRL + LSHIFT]
11. **"БАЛЛОНЫ АВТ - РУЧН"** (Fire extinguisher select) Fire extinguisher activation mode switch. This switch can be placed in the left position to select the first fire extinguisher ("АВТ"), in automatic mode or placed in the right position to select the second fire extinguisher ("РУЧН") manually. Generally, keep the switch in the automatic position unless you want to fire the second extinguisher manually. Cover [Z + RALT + RCTRL + RSHIFT], switch. [Z + RCTRL + RSHIFT]
12. **"ОГНЕТУШ – ОТКЛ – КОНТР"** (Fire extinguisher Work – Off – Test) Fire extinguisher Work – Off – Test switch. Cover [Z + LALT + LCTRL + LSHIFT], switch. [Z + LCTRL + LSHIFT]
13. **"СИГНАЛИЗ – ОТКЛ"** (Alarm - OFF). Enable the fire monitoring and alarm system. [Z + RALT + RSHIFT]
14. **"КОНТРОЛЬ ДАТЧИКОВ I ГР – II ГР – III ГР"**. Select 1<sup>st</sup>/2<sup>nd</sup>/3<sup>rd</sup> fire warning sensors groups BIT selector. [Z + RSHIFT]

## Fuel Shutoff Valve Control



### 2-56: Fuel shutoff valve control

This panel controls flow of fuel from the fuel tanks to the engine and allows the main fuel tanks to cross feed from each other. This panel is also used to open fuel flow to the APU. Prior to APU and engine start, you will need to enable these switches.

1. **"ДВИГ. ЛЕВ. – ЗАКРЫТО"** (Left engine – Closed) left engine fuel valve switch [J + RCTRL + RSHIFT] and cover. [J + RALT + RCTRL + RSHIFT] Placing this switch in the up position opens the fuel valve between the fuel tanks and the left engine. Open this valve prior to left engine start. Placing it in the down position closes the valve.

2. **"ДВИГ. ПРАВ. – ЗАКРЫТО"** (Right engine – Closed) right engine fuel valve switch [K + RCTRL + RSHIFT] and cover. [K + RALT + RCTRL + RSHIFT] Placing this switch in the up position opens the fuel valve between the fuel tanks and the right engine. Open this valve prior to right engine start. Placing it in the down position closes the valve.
3. **"ВСУ – ЗАКРЫТО"** (APU – Closed) APU fuel valve [L + RCTRL + RSHIFT] switch and cover. [L + RALT + RCTRL + RSHIFT] Placing this switch in the up position opens the fuel valve between the fuel tanks and the APU. Prior to starting the APU, this valve must be open. Placing it in the down position closes the valve.
4. **"КРАН КОЛЬЦЕВ. – ЗАКРЫТО"** (Cross feed – Closed) fuel tank cross feed switch [; + RCTRL + RSHIFT] and cover. [; + RALT + RCTRL + RSHIFT] When this switch is in the up position, the two main fuel tanks will automatically transfer fuel between them. This helps better balance the aircraft but note that damage to one main tank can then cause both tanks to lose fuel. Unless you have damage to one of the main fuel tanks, it is better not to isolate them and allow them to cross feed from each other.

## Transmission/Oil Pressure and Temperature Gauges



### 2-57: Transmission and engine oil pressure and temperature gauges

This set of six gauges provides monitoring of oil pressure, transmission oil pressure, and engine oil pressure for both engines.

1. Left engine oil pressure
2. Right engine oil pressure
3. Transmission oil pressure
4. Left engine oil temperature
5. Right engine oil temperature
6. Transmission oil temperature

## Onboard Equipment Control Panel

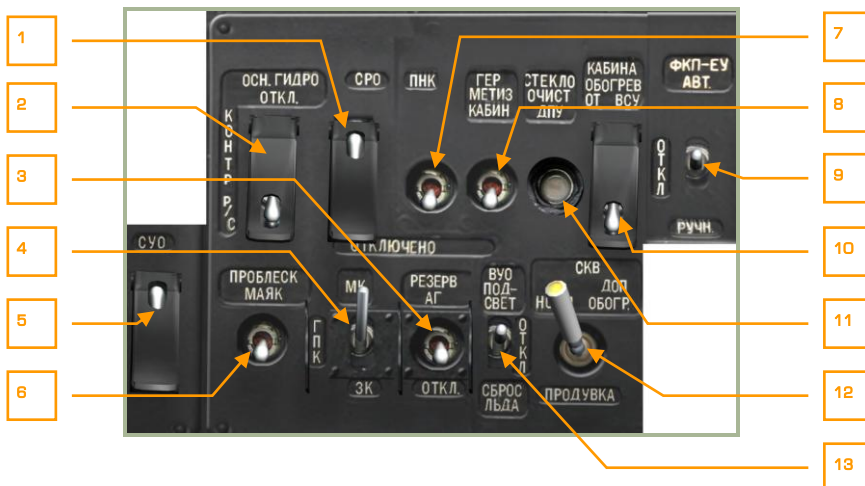

### 2-58: Onboard equipment control

Unlike other panels on the right side of the cockpit that are grouped into like-controls, this panel has a wide assortment of controls. These controls include:

1. **"СРО - ОТКЛ"** (IFF power – OFF) IFF power switch [I + LALT + LSHIFT] and cover. [I + LALT + LCTRL + LSHIFT] No function.
2. **"ОСН ГИДРО – ОТКЛ"** (Main hydraulics – OFF) switch [H + LALT + LSHIFT] and cover. [H + LALT + LCTRL + LSHIFT] Switch flight control system hydraulic source between main and common hydraulics.
3. **"РЕЗЕРВ АГ – ОТКЛ"** (SAI – OFF) Standby Attitude Indicator ON-OFF. Provides power to the SAI. [N + RSHIFT]
4. **"МК – ГПК – ЗК"** (Magnetic Heading - Flight gyroscope – Manual Heading) switch. Heading data selector for INU alignment. Flight gyroscope is used by default. [G + LALT + LSHIFT]
5. **"СУО – ОТКЛЮЧЕНО"** (Weapon system – OFF) Weapon control system power (WCS), ON-OFF switch [D + LSHIFT + LALT] and cover [D + LCTRL + LSHIFT + LALT] Provides power to weapon control system.
6. **"ПРОБЛЕСК МАЯК"** (Anti-collision beacon). When placed in the up position, the rotating, red anti-collision beacon will operate. To turn off the beacon, place the switch to the down position. [J + RSHIFT]
7. **"ПНК ВКЛ – ОТКЛ"** (Targeting Navigation system ON – OFF) switch. This switch governs power and ground checks for the targeting navigation system. [N + LSHIFT]

**Note:** When in flight, use the K-041 switch to provide electrical power for both navigation and targeting systems.

8. **"ГЕРМЕТИЗ КАБИН – ОТКЛЮЧЕНО"** (Cockpit pressurization ON – OFF) switch. No function.
9. **"ФКП-ЕУ АВТ – ОТКЛ – РУЧН"** (Gun camera, Automatic – OFF – Manual) switch. No function.
10. **"КАБИНА ОБОГРЕВ ОТ ВСУ – ОТКЛ"** (Cockpit heating from APU, ON-OFF) switch. No function.
11. **"СТЕКЛОЧИСТ ДПУ"** (Windshield wiper Shkval optics ON-OFF) button [M + LSHIFT + RCTRL].
12. **"СКВ НОРМ – ДОП ОБОГР – ПРОДУВКА"**. Air conditioner ON – Additional Heat-Fan ON, middle position – OFF. No function.
13. **"ВУО ПОДСВЕТ – ОТКЛ – СБРОС ЛЬДА"** Deicing system, back lighting ON – OFF – Deicing ON. No function.

## Lighting Control Panel



### 2-59: Lighting control

This panel is devoted to external and cockpit lighting controls. Functions include:

1. **"КОНТУР. ОГНИ"** (Rotor tip lights) switch. Tip lights on the lower three blades can be turned on by setting this switch to the up position. Tip lights can be useful in helping to gauge blade clearance to nearby obstacles and for formation flying. [J + RALT]
2. **"СТРОЕВ. ОГНИ"** (Formation lights) switch. Formation lights are low-intensity light-strips located on the back of the fuselage and the wings. The switch has four positions that include off and three levels of brightness (10%, 30% and 100%). Formation lights can only be seen at close range, so they are often used for formation flying at night without being too visible to enemy units. [J + RCTRL]
3. **"ПОДСВЕТ АГР ПКП."** (SAI and ADI lighting) switch. Although most of the panels and controls can be illuminated with the cockpit panel lighting switch, the SAI and ADI must have their own lighting controlled with this switch. [K + RALT + RSHIFT]
4. **"ПОДСВЕТ ПРИБОРЫ"** (Night vision cockpit lighting) switch. [K + RSHIFT]. When using night vision goggles (NVG), it is best to use this setting to provide reduced illumination compared to the general cockpit lighting panel. You may further wish to adjust the brightness of the NVGs to maximize cockpit clarity. Night vision brightness adjustment is done with the **"ЯРКОСТЬ ПОДСВЕТА"**





**ПРИБОРЫ**" (Brightness instruments) knob on the lower part of the control panel.

5. **"ПОДСВЕТ ПУЛЬТЫ"** (Cockpit panel lighting) switch. Except for the ADI and SAI, this switch turns on panel lighting for the cockpit. You would generally use such lighting when in low-light conditions and not using the night vision goggles. [K + RCTRL]

Note that the flood light switch is located along the rear left panel of the cockpit and the navigation lights are located on the overhead panel.

## Electronic Engine Governors

Two ERD-3VMA electronic engine governors are installed on the Ka-50. Each Electronic Engine Governor (EEG) is part of the electronic engine control system and is intended to control the fuel flow at high gas-generator (GG) RPM and to shut down the engine in case of power (free) turbine (PT) over-speed.

Each EEG functionally consists of GG RPM limitation contour and automatic PT protection and has the following functions.

For the GG contour:

- Maximum GG RPM limitation as a function of the ambient temperature and barometric pressure, with the purpose of maintaining constant takeoff power.
- Maximum physical GG RPM limitation up to 101%.

When the maximum GG RPM has been reached for a given temperature and pressure, the EEG reduces fuel flow via a solenoid valve. Simultaneously, the **"ОГРАН РЕЖ ЛЕВ"** (LEFT ENG PWR LIMIT) or **"ОГРАН РЕЖ ПРАВ"** (RIGHT ENG PWR LIMIT) yellow lights on the overhead panel illuminate.

For the PT protection:

- This generates an engine shut down command signal with a flashing MWL and illumination of the **"n ст ПЕРЕД ЛЕВ ДВИГ"** (LEFT ENG PT OVRSPD) and **"n ст ПЕРЕД ПРАВ ДВИГ"** (RIGHT ENG PT OVRSPD) red lights on the left portion of the main instrument panel. Simultaneously, the audio message **"Раскрутка турбины левого двигателя"** (Left engine power turbine over-speed) or **"Раскрутка турбины правого двигателя"** (Right engine power turbine over-speed) is played.

The control panel for turning EEG off and on is located on the right wall panel. There are switches for turning off and on both EEG's (left and right engines), a selector switch for GG channel test, and another switch to test both the channels of the PT contour.

When the **"ЭРД ЛЕВ"** (EEG LEFT) and **"ЭРД ПРАВ"** (EEG RIGHT) switches are in the ON (up) position and the two **"КОНТР. ЭРД"** (EEG TEST) selectors are in the **"РАБОТА"** (OPERATION) position, the electronic governors are ready for normal operation.

The **"СТ-1"** (PT-1) and **"СТ-2"** (PT-2) channels operate independently from each other. To generate an engine shut down signal it is necessary that both channels have detected a PT over-speed with a time difference of no more than 0.2 seconds. In case of a PT RPM

over-limit detection by only one channel, or by both of them but with a time gap of more than 0.2 seconds, the signal is ignored as a false alarm and no action is taken.

If during test mode with an illuminated warning light and a rotor RPM of 86.5%, the selector can be rapidly switched to the other channel (**CT-1 – CT-2**) without holding it in the middle **"РАБОТА"** (OPERATION) position; the tested engine will shut down.



## 2-60: Electronic Engine Governors

1. **"ЭРД ЛЕВ"** (Left EEG – Off) Left engine Electronic Engine Governor switch [[HOME + RCTRL](#)] and cover. [[HOME + RALT + RCTRL](#)]
2. **"ЭРД ПРАВ"** (Right EEG – Off) Right engine Electronic Engine Governor switch [[END + RCTRL](#)] and cover. [[END + RALT + RCTRL](#)]
3. **"КОНТР. ЭРД ТК – РАБОТА"** (EEG GG Test – Operation) Electronic engine governor gas generator test – Operate switch [[END + RALT + RSHIFT](#)] and cover. [[END + RCTRL + RSHIFT](#)]
4. **"КОНТР. ЭРД СТ-1 – РАБОТА – СТ-2"** (EEG PT-1 Test – Operation – EEG PT-2 Test) EEG power turbine channel 1 test – Operate – EEG power turbine channel 2 test, three-switch contactor [[END + LALT + LCTRL](#)] and cover [[END + LSHIFT + LCTRL](#)].

## Engine Power Indicator

The Engine Power Indicator is a tool to measure the equipment used to control engine power. Monitoring and control of the engines is based on the measurement of the compressor's outlet air pressure, whose value is indicated by the two yellow markers on the vertical scale. These are then compared to the central red markers on the scale that represent different engine operating modes. The position of these mode markers is proportional to the ambient air pressure and temperature.

On the central index there are three red markers: **"B"**, **"H"**, **"K"**. These correspond to the compressor's outlet air pressure at takeoff, maximum continuous, and cruise modes.

To control the operation of any mode, it is necessary to compare the position of the yellow index markers with the red mode marks (B, H, K) on the scale.

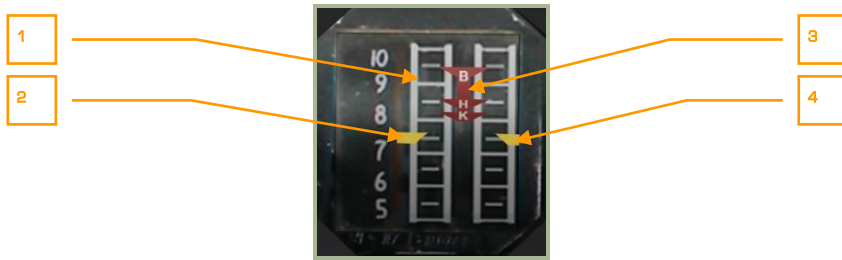

### 2-61: Engines power indicator

1. Compressor outlet air pressure scale. Scaled from 5 to 10 kgf/cm<sup>2</sup>. One division equals 0.5 kgf/cm<sup>2</sup>.
2. Left engine marker
3. Central index with marks:
  - **B** – takeoff mode
  - **H** – maximum continuous mode
  - **K** – cruise mode
4. Right engine marker

## REAR AUXILIARY PANEL

This panel is located on the back wall of the cockpit, to the pilot's right side. Like the onboard equipment control panel, this panel also has a wide assortment of controls.

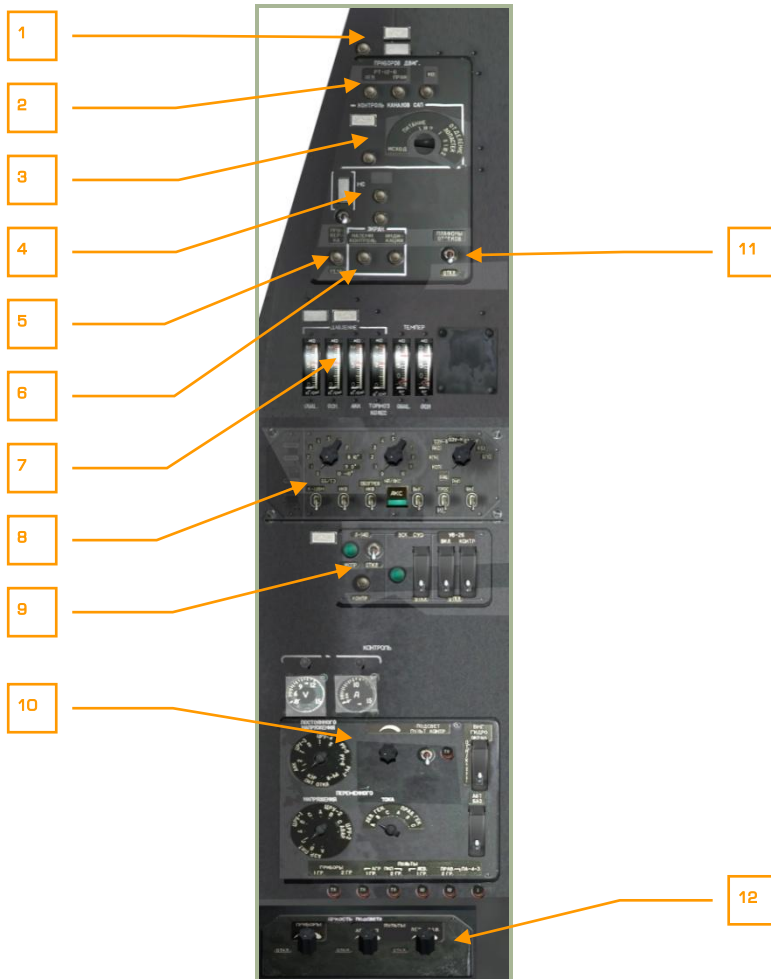

### 2-62: Rear auxiliary panel

1. Deicing control panel.
2. Engine indicators control panel.
3. Ejection system BIT panel.

4. "ABCK" Intercommunication and Radio Commutation system BIT panel.
5. Voice message unit system ("Betty") BIT.
6. EKRAN warning system Built-In Test (BIT) controls.
7. Hydraulic temperature and pressure indicators.
8. PPK-800 systems preparation and check panel.
9. L-410 laser warning system, weapon system, and UV-26 countermeasure system controls.
10. Electrical system control panel.
11. Equipment bays lighting switch.
12. Lighting brightness control panel.

## Ice Defrosting Control Panel

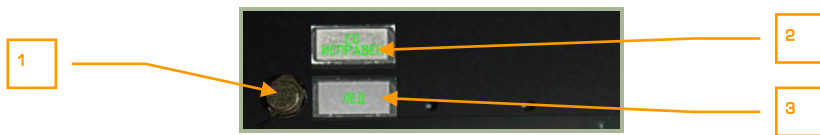

### 2-63: Ice defrosting control panel

1. Heating system BIT button. No function.
2. Heating system intact indicator.
3. Ice detected.

## Engines Control Instruments Panel



### 2-64: Engines' control instruments panel

1. "РТ-12-6 ЛЕВ" left EGT governor button. [G + RALT + RSHIFT]
2. "РТ-12-6 ПРАВ" right EGT governor button. [G + RCTRL + RSHIFT]
3. "ИВ" engines vibrations monitoring system control button. No function. [V + RALT + RCTRL + RSHIFT]

"РТ-12-6 ЛЕВ" and "РТ-12-6 ПРАВ" buttons decrease the control threshold of the EGT governors to check the serviceability of the EEG. When either of these buttons are pressed, the GG contour of the EEG disengages. If the EGT is no less than 850°C and

GG RPM is no less than 87%, then the EGT decreases by 30°C or more and the GG RPM decreases to 84% of the maximum value.

## Automatic Ejection System BIT Panel



### 2-65: Automatic ejection system BIT panel

1. Ejecting system check lamp.
2. Circuit test button. This is a circuit test of the egress system. Perform this test after the three egress switches on the wall panel have been armed. You may further set the egress mode dial to each position and press the circuit test (with the exception of the ИСХОД position. [E + RCTRL + RSHIFT])
3. **ИСХОД – ПИТАНИЕ – ОТДЕЛЕНИЕ ЛОПАСТЕЙ** – egress mode: manual, assisted, or full ejection with rotor blade separation.

## Intercom Check Panel

Intercom check panel serves for conducting pre-flight intercom SPU-9 and video tape recorder checks.

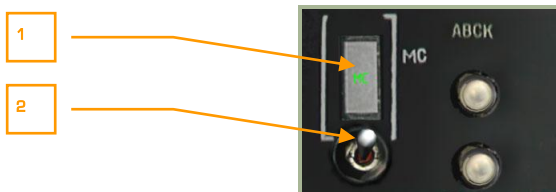

### 2-66: Intercom check panel

1. Tape recorder on/off indicator. No function.
2. Tape recorder ground check switch. No function.

## EKRAN and Voice Warning System Control



**2-67: EKRAN Warning System and ALMAZ Voice Message Unit ("Betty") BIT controls**

1. "ПРОВЕРКА РЕЧЬ" (ALMAZ Voice message ("Betty") system BIT) button. Pressing this button will run a built in test (BIT) of the EKRAN system. If the test passes, you will receive an affirmative voice message. [V + RALT + RCTRL]
2. EKRAN ground control button. No function.
3. EKRAN revert to flight control button. No function.
4. Equipment bays lighting switch. No function.

## Hydraulic Temperature and Pressure Indicators

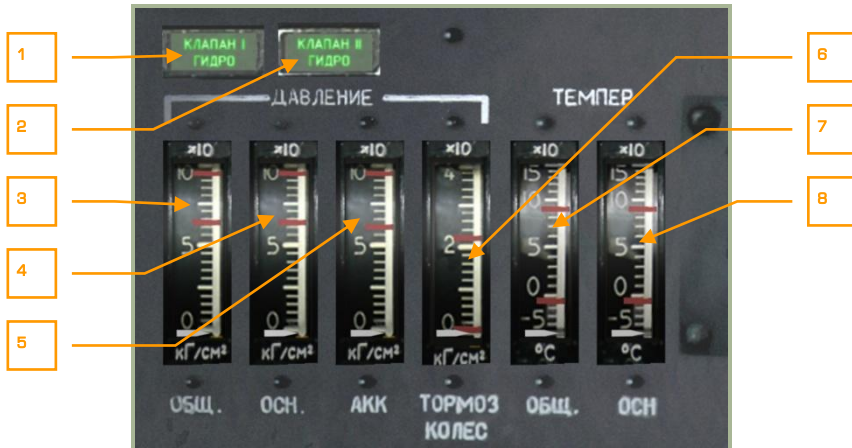

**2-68: Hydraulic Temperature and Pressure Indicators**

This set of indicators monitor the hydraulic pressure to the aircraft's sub-systems and the state of the hydraulic systems.

1. "КЛАПАН I ГИДРО" (Hydraulic valve #1) lamp. When the main hydraulic switch on the right console is set to on, the right hydraulic valve will open and this lamp will light.

2. **“КЛАПАН II ГИДРО”** (Hydraulic valve #2) lamp. When the main hydraulic switch on the right console is set to on, the right hydraulic valve will open and this lamp will light.
3. **“ДАВЛЕНИЕ ОБЩ”** (Common pressure) hydraulic pressure indicator.
4. **“ДАВЛЕНИЕ ОСН”** (Main pressure) hydraulic pressure indicator.
5. **“ДАВЛЕНИЕ АКК”** (Accumulators pressure) hydraulic pressure indicator.
6. **“ДАВЛЕНИЕ ТОРМОЗ КОЛЕС”** (Wheel brakes pressure) hydraulic pressure indicator.
7. **“ТЕМПЕР ОБЩ”** (Common temperature) common hydraulic temperature indicator.
8. **“ТЕМПЕР ОСН”** (Main temperature) main hydraulic temperature indicator. Please refer to the hydraulics section of this manual for greater detail.

## PPK-800 Systems Preparation and Check Panel



### 2-69: System preparation and check panel

Located mid-way down the back right panel, the PPK-800 panel provides additional weapon and navigation controls. These include:

1. Computer malfunction lights. There are five lights that illuminate in regards to a computer malfunction:
  - **“ЦВМ-Б”** (combat computer)





- **"ЦВМ-Н"** (navigation computer)
  - **"ЦВМ-И"** (indication computer)
  - **"ЦВМ-Ц"** (data link computer)
  - **"УВВ"** (input-output device). No function.
2. **"ББ/ТЗ"** selector. Outside temperature setting for anti-tank guided missile (ATGM) flight control system pre-launch adjustments. No function.
  3. **"НР/АКС"** selector. Unguided rocket and gun pods ballistics data settings.
    - 0 – S-8KOM rockets with anti-tank/antipersonnel warhead
    - 1 – S-8Tsm rockets with smoke warhead
    - 2 – S-13 rockets
    - 3 – S-24 heavy rockets. Not used
    - 4 – S-25 heavy rockets. Not used
    - 5 – UPK-23 gun pods, twin 23mm

The ballistic data is used for impact point calculation. The selector position must match the selected weapon; if not, the impact point will not be calculated correctly.

At the start of a mission, the rocket selector switch will be automatically set to comply with selected rockets from the mission planner. If more than one rocket type is selected, the selector will set first rockets by hard point number (outer on the left wing is #1 and outer on the right wing is #4).

Before a second rocket type is used, you must select the dial position manually for the rocket type of gun pod.

The same operation must be done after rearming the helicopter during a mission.

4. **"РНП"** selector. Weapon control BIT mode selector. No function.
5. **"К-ЦВМ – ОТКЛ"** switch. Computer BIT. No function.
6. **"ИКВ – ОТКЛ"** (INU – OFF) switch. Inertial Navigation Unit (INU) power. INU starts alignment procedure automatically upon power on [I + RCTRL + RALT].
7. **"ОБОГРЕВ ИКВ – ОТКЛ"** (INU heater – OFF) switch. This switch is turned on prior to Inertial Navigation Unit (INU) alignment and must be enabled during INU operation [I + RSHIFT + RALT].
8. **"АКС"** button. Weapon control system BIT. No function.
9. **"Вн.К – ОТКЛ"** switch. No function.
10. **"ТРОС – ОТКЛ"** (Stabilization of sling load suspension cable - Off) switch. No function.
11. **"ФКП – ОТКЛ"** (HUD video recorder – Off). No function.

## LWS, WS and CMS Power and Test Panel

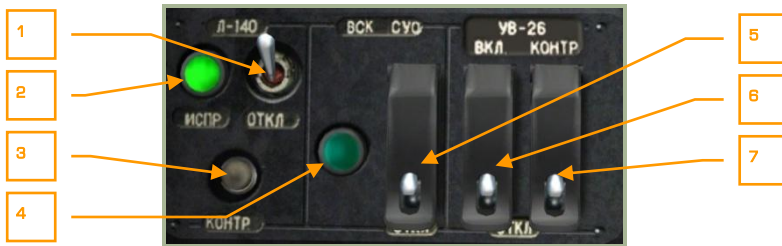

### 2-70: Laser warning system L-140, weapon system and UV-26 countermeasures system control equipment panel

This panel is the power and test panel for the laser warning system (LWS), weapon system (WS), and counter measures system (CMS).

1. “**Л-140 – ОТКЛ**” (LWS power – OFF) switch. Setting this switch to the up position provides power to the LWS system. Once power is provided, you may perform a self-test and use the LWR panel. [\[N + LCTRL\]](#)
2. “**Л-140 ИСПР**” (LWS operation) lamp. After the LWS has been provided power and the system has fully powered up after approximately 30 seconds, this green indicator lamp will come on. If you perform an LWS self-test, the lamp will shut off for approximately 30 seconds while the test is performed.
3. “**Л-140 КОНТР**” (LWS self-test) button. Pressing this button while the LWS is powered will initiate a 30 second self-test. During this time, the operation lamp will be off to indicate that the LSW is offline. [\[N + LALT + LCTRL\]](#).
4. “**ВСК-СУО**” (Weapon system built-in test) indicator. No function.
5. “**ВСК-СУО – ОТКЛ**” (Weapon system built-in test) switch. No function.
6. “**УВ-26 ВКЛ – ОТКЛ**” (Countermeasures system power) switch [\[C + LCTRL + LSHIFT\]](#) and cover. [\[C + LALT + LSHIFT\]](#) Placing this switch in the up position will provide power to the UV-26 system and the control panel over the front dash will be operational.
7. “**УВ-26 КОНТР – ОТКЛ**” (Countermeasures system self-test) switch [\[C + LALT + LCTRL\]](#) and cover. [\[C + LALT + LCTRL + LSHIFT\]](#) Setting this switch to on will place the UV-26 in a self test mode as long as the switch is in the up position. If the system is operating normally, the UV-26 will display a “990” status code.

## Electrical System Control Panel



### 2-71: Electrical System Control panel

1. **Amp meter.** No function.
2. **Volt meter.** No function.
3. **DC volt meter electric distribution assembly selection.** No function.
4. **Alternate current ammeter phase selector.** No function.
5. **AC voltmeter electric distribution assembly selection.** No function.
6. **Rear panel lighting brightness knob.** By rotating this knob, you can control the brightness of the rear panel illumination. Increase [U + LSHIFT + CTRL + LALT] and decrease [U + LSHIFT + CTRL + RALT].
7. **“ПОДСВЕТ ПУЛЬТ КОНТРОЛЯ – ОТКЛ”** (Panel lighting – Off) switch. Place this switch in the up position to turn on rear panel switch and indicator illumination. [L + RALT + RShift]
8. **“ВМГ ГИДРО ЭКРАН – ОТКЛ”** (Hydraulics/transmission group and EKРАН power supply) switch [N + CTRL + LSHIFT] and cover. [N + LALT + CTRL + LSHIFT] Provides power to EKРАН Warning System, hydraulics, and transmission group control sensors.
9. **Circuit breakers.** No function.

## Lighting Brightness Control Panel



### 2-72: Lighting brightness control panel

1. **"ПРИБОРЫ"** Blue cockpit lighting brightness for night operations. Rotating this knob allows you to adjust the brightness level of the blue cockpit lighting. Increase [K + LCTRL + LALT] and decrease [K + LSHIFT + LCTRL].
2. **"ПУЛЬТЫ АГР. ПКП"** SAI/ADI brightness regulator. Increase [J + LCTRL + LALT] and decrease [J + LSHIFT + LCTRL].
3. **"ПУЛЬТЫ ЛЕВ. ПРАВ."** Left/right panels brightness regulator. Increase [L + LCTRL + LALT] and decrease [L + LSHIFT + LCTRL].

## LEFT PANEL



### 2-73: Left panel

The left panel is comprised of four primary areas that include:

1. R-800L1 command VHF radio station control
2. Targeting mode control panel
3. Engine start-up control panel
4. Radio intercom control

## R-800L1 VHF Radio Control System

The R-800L1 is a VHF-2 command radio system. The radio system is turned on using the VHF-2 ("УКВ-2") switch on the right panel. This radio can be used to communicate with other airborne units and provide reception of ADF signals.

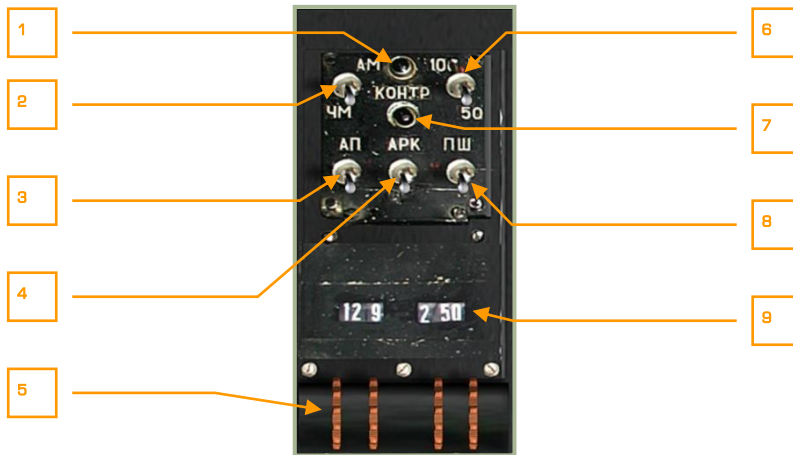

### 2-74: R-800L1 radio control system

The R-800L1 is a VHF transceiver radio that can operate in both FM and AM bands and also has the ability to receive navigation beacon signals. To receive information from this radio, you will need to set the radio intercom dial to the "(CA)УКВ-2" position.

1. "КОНТРОЛЬ" (Test) lamp. If the "КОНТРОЛЬ" built-in-test (BIT) test button is held down and the radio passes the test, this lamp will light. Note that the "УКВ-1" VHF-1 R-828 radio switch and the "УКВ-2" VHF-2 R-800 radio switch on the right panel should be set to on (up).
2. "АМ-ЧМ" (AM-FM) switch. Selecting this switch allows you to toggle between AM (up) and FM (down) bands on the radio. [M + LALT + LCTRL]
3. "АП" (Emergency radio receiver) switch. When placed in the up position, this places the radio in a fixed emergency radio receiver frequency, used to receive emergency signals. In the western world, this may be viewed as a guard channel. When activated, the frequency automatically switches to 121.5 MHz and the transmitter is turned off. [E + LALT + LCTRL]
4. "АРК" (ADF) switch. When this switch is moved to the up, on position, the radio is used for automatic direction finding (ADF). The radio compass antenna is then connected to the R-800L1 radio receiver, and the receiver controls radio compass antenna direction (this in turn controls direction of the HSI RMI arrow). The HSI RMI arrow will now point in the direction of the transmitter with the frequency that is defined on the R-800L1. [A + LALT + LCTRL]  
A complete list of available ADF channels can be viewed in the Automatic Direction Finder (ADF) ARK-22 section of this manual.
5. Radio frequency thumb wheels. These four ridged wheels can be rotated to input frequencies. The frequency is entered in kHz in 25 kHz steps. The two left wheels indicate integer MHz values and the two right wheels indicate one-thousandths of MHz values.

- Rotary 1 up [1 + LCTRL + LSHIFT]



- Rotary 1 down [1 + LALT + LCTRL]
  - Rotary 2 up [2 + LCTRL + LSHIFT]
  - Rotary 2 down [2 + LALT + LCTRL]
  - Rotary 3 up [3 + LCTRL + LSHIFT]
  - Rotary 3 down [3 + LALT + LCTRL]
  - Rotary 4 up [4 + LCTRL + LSHIFT]
  - Rotary 4 down [4 + LALT + LCTRL]
6. "100-50" switch. This switch controls data transfer rate [5 + LCTRL + LALT].
  7. "КОНТРОЛЬ" (BIT) button. Pressing this button performs radio system self-diagnostics. If self-diagnostics passes, the "КОНТРОЛЬ" indicator test lamp will light. [T + LCTRL + LSHIFT]
  8. "ПШ" (Noise reduction) switch. Placing this switch in the up position activates the noise reduction system (squelch). This reduces volume if the inputted frequency is not detected. [R + LALT + LCTRL]
  9. Selected frequency display. These two fields combine to show the inputted frequency as determined by the thumb wheels.

When flying in the region of Maikop City, you can set the radio to AM mode with a frequency of 125675. If you are within a 70 km radius of the radio tower at Maykop airdrome, you will here broadcasts from "Radio Mayak". If you are not a fan of their top 40 list, you can replace it with your own audio files:

||*Sounds\Samples\RadioMayak* folder

The files will need to be in OGG or WAV format.

## Targeting Mode Control Panel

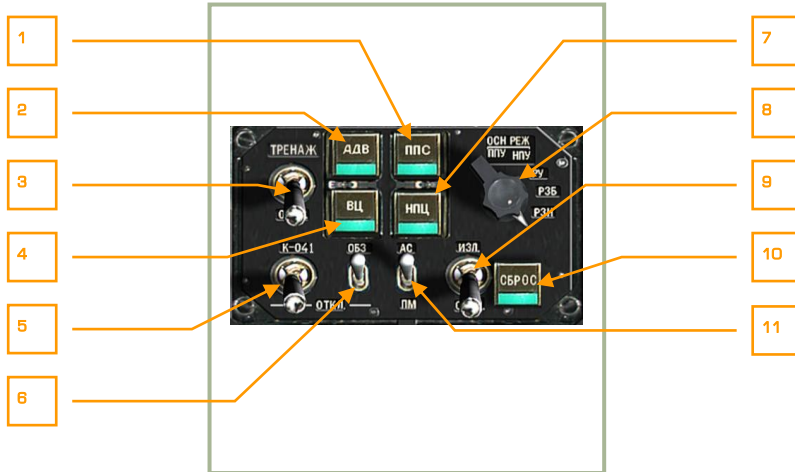

**2-75: Targeting mode control panel**

The targeting mode control panel is your primary means of manipulating the Ka-50 as an integrated weapon system. From this panel you can control aspects of the sensors, weapons, and laser.

If you have a programmable joystick, you may find it useful to map some of these functions to your stick. In the heat of battle, taking your hand off the stick to activate a targeting mode may get you killed.

1. **"ППС"** (Head-on airborne target) button. Pressing this button will adjust the fuze of the Vikhr ATGMs onboard to use a proximity fuze suited to attacking airborne targets in the forward hemisphere (high aspect). [[S](#) + [LALT](#)]
2. **"АДВ"** (Automatic turn on target) button. If you have a target designated with the Shkval and press this button, the aircraft will automatically point its nose towards the target. This is a useful function when you have locked a target far off the weapon system boresight. [[Q](#)]
3. **"ТРЕНАЖ – ОТКЛ"** (Training mode – OFF) switch. Placing this switch in the up **"ТРЕНАЖ"** (Training mode) position places the weapon system in training mode and it will not allow a weapon to be released. However, full weapon aiming and target locking is allowed. When in the lower **"ОТКЛ"** (OFF) position, the system is taken out of training mode.
4. **"ВЦ"** (Airborne target) button. When targeting an aircraft with Vikhr and the aspect is changing or is other than high-aspect, press this button to set the missile to use a general proximity fuze. With a proximity fuze, the warhead will detonate when it is close to the target and does not require a direct hit. [[V](#)]
5. **"К-041 – ОТКЛ"** (K-041 Targeting and Navigation systems power – OFF) switch. When this switch is in the up position, power is sent to the K-041.



targeting and navigation systems and the Shkval display will activate. This system is turned off by setting the switch to the down position. [D + LSHIFT]

6. **“ОБЗ – ОТКЛ”** (Helmet-Mounted Sight (HMS) / night vision goggle system power – OFF) switch. This switch allows you to either enable the HMS or NVG systems. These can be interchanged when you are on the ground and in radio contact with the ground crew. Returning the switch to the down position turns them off. [H]
7. **“НПЦ”** (Moving ground target mode) button. If the Shkval is tracking a moving target and you press this button prior to launching a Vikhr ATGM, the weapon control system will adjust the Vikhr launch parameters to account for a moving target and thereby increase accuracy. The targeting system will also calculate lead for gun and rockets employment. [N]
8. **“ОСН РЕЖ”** Weapon system mode selector dial can be rotated left [F + LCTRL] and right. [F + LALT] This five position dial allows you to adjust the fire control system. These positions are:
  - **“НПУ”** (Moving canon – automatic weapons mode) allows the cannon to be slaved to the Shkval line of sight. The ATGMs launchers will adjust their vertical angle automatically. This is the primary automatic mode and all functions are calculated using a full set of weapon data for employment.
  - **“НПУ”** (Fixed cannon) fixes the cannon boresight along the zero sight line of the aircraft fuselage. This is generally used in case of a cannon-drive malfunction.
  - **“ПУ”** (Backup/manual mode) can be used as a backup/manual mode for weapon employment. In this mode, range and lead are not calculated, the gun is fixed, the ATGMs launchers do not adjust their vertical angle, the Shkval tracking gate does not adjust automatically, and there is no memory mode target tracking.
  - **“РЗН”** (Backup navigation tasks on the combat computer) mode can be used to update the aircraft’s inertial navigation unit (INU). This is a less capable of way of updating navigation but both the navigation and weapon computers can partially replace each other.
  - **“РЗБ”** (Backup combat tasks on the navigation computer) mode. In case of a combat computer malfunction, you can select this mode to route combat tasks to the navigation computer with limited functionality.
9. **“ИЗЛ – ОТКЛ”** (Laser standby – OFF) switch. Place this switch in the up position to arm the laser. Note that to get accurate targeting range and be able to designate for the Vikhr ATGM, the laser must be active. [O + RSHIFT]
10. **“СБРОС”** (Targeting mode reset) button. To the cease targeting and return the HUD to the navigation mode, press this button. [BACKSPACE]
11. **“АС – ПМ”** (Automatic tracking – gun sight) automatic tracking/targeting without Shkval system with manual laser sight ranging. Without laser ranging, the gun reticle is adjusted to a fixed range of 1100 m. [P]

## Engine and APU Start-Up Controls



### 2-76: Engine start-up controls

This panel provides you the controls to start either engine or the APU. To start an engine though, several conditions must be met:

- APU running (see APU section below and the steps needed to start the APU)
- Left/right engine fuel shutoff valves to open
- Left/right engine cutoff levers to the up position
- Rotor brake to the down position
- Engine / APU select switch to either engine 1 or engine 2
- Press engine start button
- Monitor engine RPM and temperature

The engine start-up panel has the following functions:

1. **"ЗАПУСК"** (Start) engine/APU start button. Assuming all start-up conditions are met, pressing this button will start either the APU or one of the engines, depending on the position of the engine selector switch. [[HOME](#)]
2. **"ЗАПУСК – ПРОКРУТКА – ЛОЖНЫЙ ЗАПУСК"** (Start up – crank – false start) start-up mode selector. This is a three position selector that determines the method of start-up ignition. The most often used mode will be the top **"ЗАПУСК"** (start) setting. The middle **"ПРОКРУТКА"** (crank) position is used to purge fuel after a failed start and the bottom **"ЛОЖНЫЙ ЗАПУСК"** (false start) setting is used for start-up check procedure during ground maintenance. [[E + LALT](#)]
3. **"КЛАПАН ЗАПУСКА"** (APU air bleed valve) lamp. Indicates when lit that the APU air bleed valve is working during the engine start-up cycle.

4. **“СТОП ЗАПУСК”** (interrupt start-up sequence) button. If during an engine start cycle you need to abort it, you may press this button to shut down the engine start. [HOME + RALT]
5. **“ОСТАНОВ ВСУ”** (APU shutdown) button. After both engines are running normally and the batteries are recharging from the generators, you may press this button to turn off the APU. With both engines running, there is no need for it. [END]
6. **“ТУРБОПРИВОД – ВСУ – ДВИГ ЛЕВ – ДВИГ ПРАВ”** (Turbo gear – APU – Left Engine – Right Engine) select switch. This is a four position switch that enables you to select either the APU (center), left engine (lower left), or right engine (lower right). When set to the top position, the system is placed in “turbo gear” mode and allows for system tests (generators and hydraulics primarily) without starting the engines. This is generally done only for maintenance and must be requested through a maintenance radio command. [E]

## Radio Intercom SPU-9 Panel



### 2-77: Radio panel

This SPU-9 panel allows you to select the radio audio source that you hear through your headphones and what radio you transmit on. This is a rotary dial with four possible selections:

1. **“СБРОС”** (Reset) button. This button resets the jam-resistant secure communications codes. No function.
2. The intercom source selector dial for the SPU-9 has four settings: [ / + LALT + LCTRL]
  - **“(СА)УКВ-2”** (VHF-2) – Selects the VHF-2 R-800L1 radio.
  - **“УКВ-1”** (VHF-1) – Selects the VHF-1 R-828 radio for communications with ground units.
  - **“КВ”** (SW) – Short waves band. Not used.
  - **“НОП”** (Ground crew intercom) – used to communicate with ground crew through the wired telephone. When rearming or refueling at an airfield or FARP, you will need to select this setting to communicate with the ground crew unless the cockpit door is open and the rotors are not turning.

## Auxiliary Power Unit (APU) Control

The control panel for the auxiliary power unit (APU) is located along the left side of the cockpit, next to the collective. The APU serves two primary functions: it can provide bleed air to start the engines, and it can generate electrical power (via turbo gear). In order to start the engines, you must first have the APU operating.

To power on the APU, you must first satisfy the following conditions:

- 1- Electrical power on (batteries or ground power source)
- 2- Forward and aft fuel tank pumps turned on
- 3- Open the APU fuel shutoff valve
- 4- Set the Engine / APU select switch to the APU position
- 5- Press the engine start button



### 2-78: Auxiliary Power Unit (APU) panel

1. **"КРАН ВСУ ОТКРЫТ"** (APU fuel shutoff valve is open) light. This light indicates that the APU fuel shutoff valve is set to open.
2. **"ОСТАНОВ ВСУ ПО n"** (APU shutdown due to RPM limit) light. Although you will not see this often, this light indicates that the APU has stopped running due to an over-revving state. This would most likely happen if you are operating at high altitudes such as a mountain FARP.
3. **"П МАСЛА ВСУ"** (Oil pressure) light. This light will be visible when APU oil pressure is detected within acceptable limits.
4. **"ВСУ ВКЛЮЧЕНА"** (APU operate) light. If the APU has been started successfully, this light will indicate nominal operation.
5. APU exhaust gas temperature gauge. After the APU has been started, it will begin generating heat and this can be monitored from this gauge. The APU will peak at 680°C at start but will generally stabilize at 590...600°C.

After both engines have been started and are running normally, you may turn off the APU. To turn off the APU, it is best to press the stop APU button and then close the APU fuel shutoff valve.

ВНИМАНИЕ!  
ПРИМЕНЯТЬ КАСЕТЫ  
С ЗАВОДСКОГО № 50180551



КОНТРОЛЬ Т° ГАЗ  
ДВИГ

РАБОТ НЕ РАБОТ



3

ABRIS  
AMMS

## 3 ADVANCED MOVING MAP SYSTEM AMMS (ABRIS)

### PURPOSE

The ABRIS is designed to supplement other onboard navigation systems, like the PVI-800, and to accomplish aerial navigation through: route preparation and planning, map support in all the sortie phases, processing of information from the navigational sensors, output of information to interfaced systems, navigation calculations, tactical situation display, and data link of target coordinates.

The ABRIS provides:

- Storage and presentation of electronic, topographic maps on the color display and the ability to electronically update and reload multiple map data-sets.
- Continuous determination of ownship "ACFT" position coordinates and display of the ACFT position on the moving map (on a scale suitable for the operator).
- Creation and display of flight plan information for tasks in different sortie phases.
- Creation of a flight route, the recording of the route in the database, and being able to load a route from the database.
- Ability to quickly modify a route while in-flight.
- The reception and display of information from interfaced systems and the output of information to other interfaced systems.

### ABRIS PANEL CONTROLS

The ABRIS controls are arranged along the bottom of the control panel and the controls include:

- **Function select keys (FSK).** There are five function select buttons that have a variable function according to the system's current operation mode or sub-mode.
  - Button 1 [1]
  - Button 2 [2]
  - Button 3 [3]
  - Button 4 [4]
  - Button 5 [5]

- **Brightness control knob.** Located to the left of the FSK buttons, this knob may be rotated to adjust the backlighting of the display up [0] and down. [9]
- **Cursor manipulator knob.** Located in the bottom right corner of the panel, this knob allows the on-screen cursor to be moved horizontally and vertically. A press of the button [6] cycles a function or toggles vertical control and horizontal control. Rotating the knob moves the cursor either left [7] and right [8] or up and down depending on movement mode. This knob can also be used to input alphanumeric information, selection of menu items, and input desired track angle. When in Alphanumeric/numeric data input mode, rotate the knob (mouse wheel) to search for the necessary characters and then press and release the knob (mouse right button click) to switch to the next character position. When the cursor manipulator is pressed in the position of the right-most character, it automatically switches to the leftmost (first) character (home).

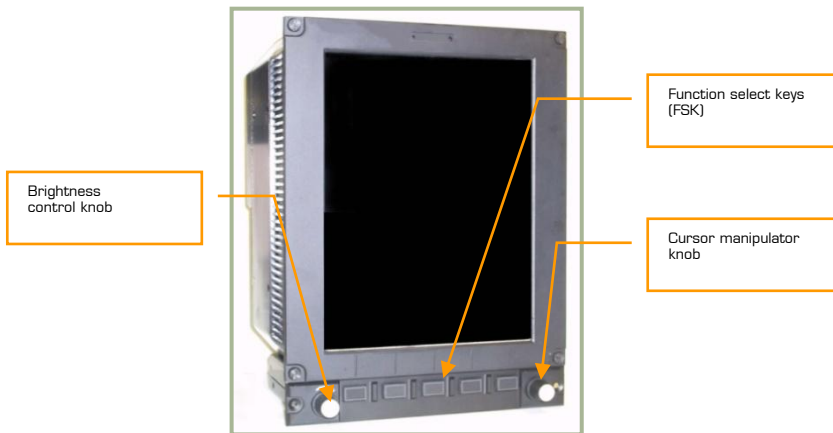

### 3-1: The ABRIS panel and controls

For the brightness and cursor manipulator knobs, you can also rotate them by clicking on them and while holding the left mouse button down, moving the mouse either side to side or up and down.

## DISPLAY AND INPUT OF INFORMATION IN ABRIS

Digital and graphical information is shown in different colors on the ABRIS display depending on its function:

Message type	Color displayed in
Warnings	Yellow
Cautions	Green



Scales	White
Currently measured parameters	White
Mode	Green
Activated route	Blue

Data input is possible in all ABRIS operating modes:

The ABRIS consists of many menus and these can be navigated through by use of the cursor manipulator (right knob on control panel) or by using the '↑' and '↓' arrow FSK buttons. Rotating the cursor manipulator clockwise moves menu item selection up and rotating it counter-clockwise moves selection of menu items down. When the cursor manipulator is used to select items from a menu, it ensures a smooth transition from one item to the next with a mandatory stop on each item. When two of the function select key (FSK) buttons are set as "Up" and "Down" arrows, these can be used to select items from a menu; one press corresponds to one item step up or down.

Input of alphanumeric values is also provided via the cursor manipulator:

- Clockwise rotation of the cursor manipulator increases the digital value and cycles through the letters of the alphabet, numbers, and special symbols. A counter clockwise rotation reduces/moves backwards through the selections.
- To switch from one character to the next, press the cursor manipulator axially.

## TURNING ABRIS ON/OFF

After AC electrical power is supplied (ground power, batteries, or generators) and the ABRIS power switch has to be set to on, the ABRIS will start to function. Using the batteries, the AC/DC converter must set to "ABT" (Auto position). Once turned on, the ABRIS will start an automatic self-test that can take up to 120 seconds. After the self-test is complete, the self-test page will be replaced by the MENU operating mode page. At start up, the ABRIS will automatically go through an alignment process and NAV ERROR will be displayed at the top of the MENU page in yellow until alignment is complete. To shut down the ABRIS, turn off the ABRIS power switch or remove electrical power. [0 + RSHIFT]



```
STARTING BIOS.....
CPU :486DX4.....OK
MEMORY :2097152KB.....OK
VIDEO :EDGA32768KB.....OK
MOUNTED FLASH
BOOTING EDOS.....
ABRIS STARTED
ABRIS PERFORMING FULL TEST
```

3-2: ABRIS in self-test mode

```
MENU 30 09:00:13L
DATA DATE SETUP: 22:06:2004
NAVIGATION DATA 22:06:2004
TOPO DATA 22:06:2004
COMPANY ROUTES 1 22:06:2004
ADDITIONAL INFO 2 22:06:2004
TERRAIN DATA 22:06:2004
PERF 22:06:2004
ROUTES 2 22:06:2004
METEO 22:06:2004
SEA CHARTS ND

NAV_SENSORS
GNSS READY
ALTIMETER READY

RESOURCE 15
S/N BP8UVCR0C84NYE0FCRES35J7
VERSION SW L012BETA

OPTION CTRL PLAN GNSS NAV
```

3-3: ABRIS MENU page after self-test and alignment

# DISPLAY OF INFORMATION IN ABRIS

The ABRIS display is divided into the following areas:

- System bar
- Main field
- Chart field
- Flight information area
- Fields for dynamic Function Select Keys
- Pop-up menu

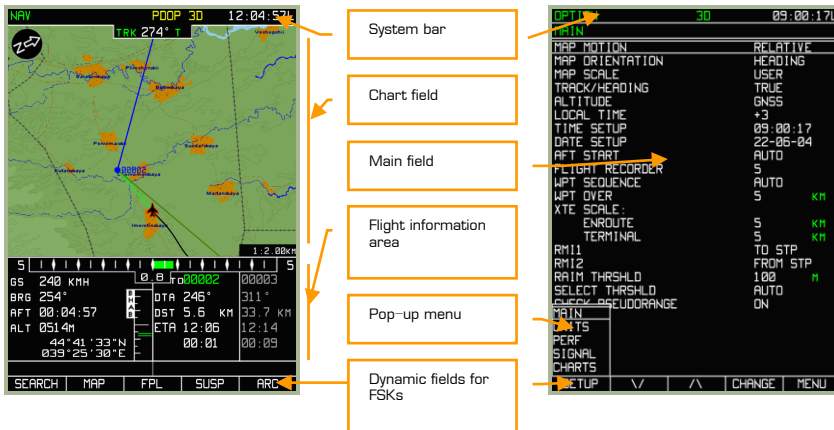

## 3-4: Main information display areas

### System Bar

The system bar is used to display current time, Global Navigation Satellite System (GNSS) sensor status, and the selected ABRIS operating mode. The system bar is displayed along the top of the display regardless of the selected operating mode. The system bar consists of the three main fields.



## 3-5: System bar fields

For modes that have sub-modes, the current sub-mode is indicated in the top left corner of the screen under the mode field.

Navigation and GNSS messages that can be displayed in the system bar field are listed in the table below:

Message	Meaning
3D	3D navigation supplied by onboard sensor
EXCL 3D	3D navigation with one satellite in constellation turned off manually
PDOP 3D	Position precision dilution
HDOP 3D	Bad geometric factor
RAIM 3D	Loss of data integrity provided to the GNSS receiver
2D	ABRIS is only providing 2D navigation
ADSB 3D	3D navigation based on data transponder
ADSB	Transponder mode: 2D or unknown.
DR	Calculations of aircraft motion parameters in case of the GNSS failure, using the last received data on the ground speed and actual track angle. This mode is used for one minute after the GNSS failure, whereupon the NAV ERROR message is displayed
NAV ERROR	Impossible to determine aircraft coordinates
THRESHOLD	If the manually entered RAIM threshold value exceeds the value suitable for the route leg: non-precision approach (0.3 nm), approach (1 nm), otherwise - 1 nm

### 6-2: Navigational sensor operating mode messages

Two formats can be used in the current time field:

HH:MM:SS Z

HH:MM:SS L

In this format, HH - for hours, MM – for minutes, and SS – for seconds. If no time zone value is entered, Greenwich Time is defaulted to; in such a case the "Z" (Zulu time) indicator appears after the time. If a time zone value is entered, the field displays local time, and the time value is followed by an "L" indicator.

## OPERATING MODES

The ABRIS has four principal operating modes: **MENU**, **NAV**, **ARC**, and **HSI**. In each mode you can switch to various sub-modes using the FSK buttons. After the ABRIS has been turned on and gone through its self-test, the main MENU mode page is displayed. With each successive press on the right-most FSK button, the main modes are cycled as shown.

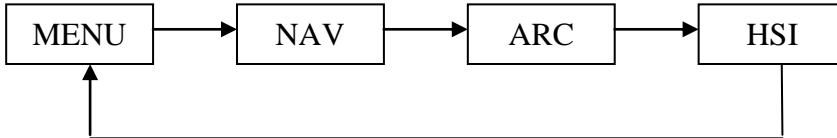

The current mode is indicated on the left side of the system bar. Navigational calculations and reception and transmission of information are performed continuously regardless of the current operating mode.

## MENU Page

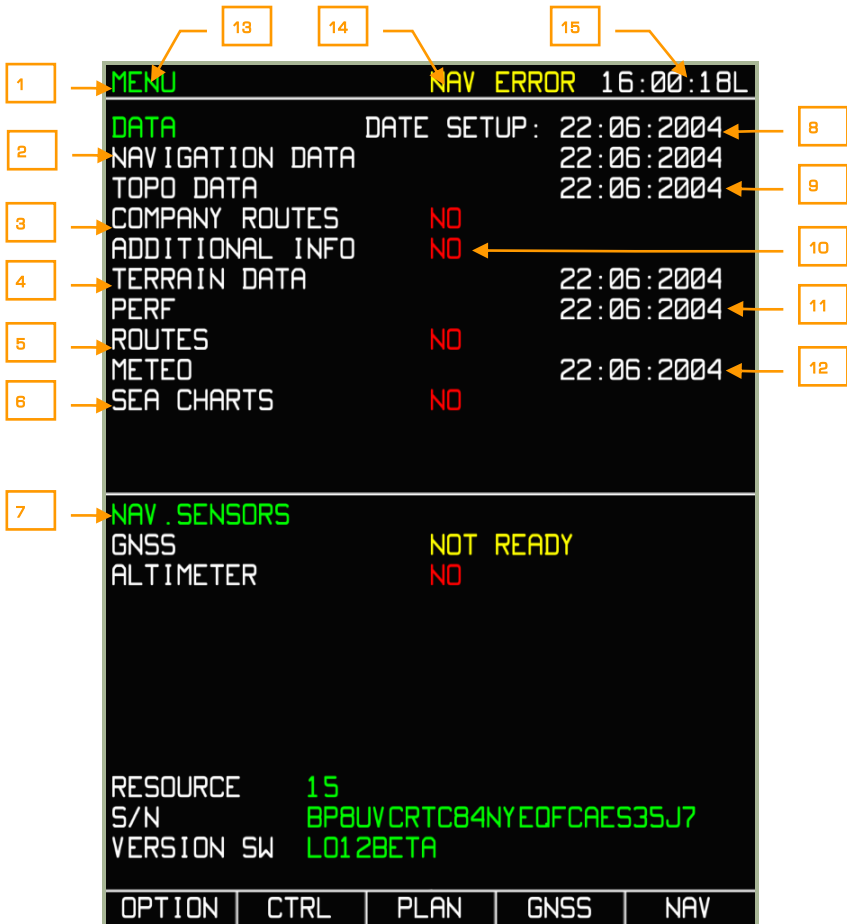

### 3-6: MENU

1. System bar
2. Aeronautical database expiration date
3. Default route of mission
4. Terrain information and database generation date
5. Number of user routes and date when latest was created
6. Sea charts, No function
7. Status of linked navigation sensors



8. Current date
9. Date when topographic data was created
10. User defined database
11. Date when data of aircraft performance characteristics was created
12. Date when METEO data was created
13. Operating mode name
14. Navigation sensors status
15. Current time

## NAV Page

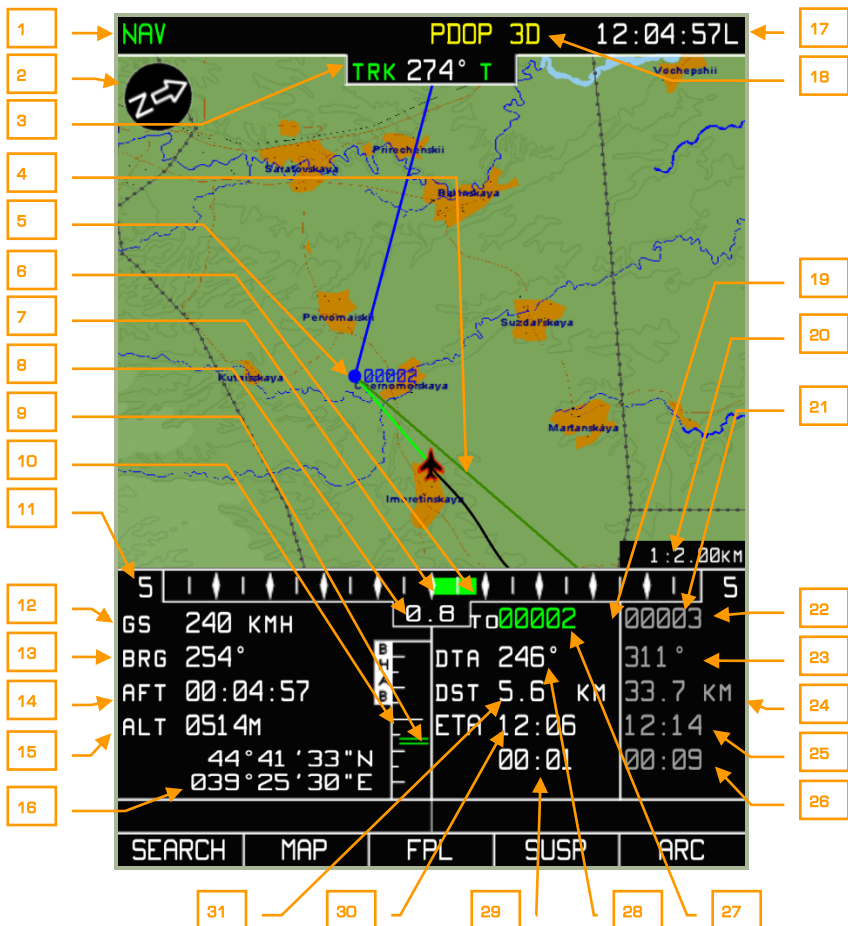

### 3-7: NAV page

1. Operating mode name
2. North arrow
3. Current track/heading. T – true or M – magnetic
4. Desired track (DTK) angle
5. Steerpoint
6. Graphical representation of lateral cross-track error (XTE)
7. XTE scale center point (on course)



8. Digital XTE level
9. Graphical representation of altitude deviation from flight plan
10. Vertical navigation scale
11. XTE scale
12. Ground speed
13. Bearing to steerpoint
14. Flight time
15. Current altitude
16. Current geographic coordinates
17. Current time
18. GNSS status
19. Current route leg combined data field
20. Map scale
21. Next route leg combined data field
22. Next Steerpoint callsign
23. Desired track angle (DTA) of next steerpoint
24. Next steerpoint leg distance
25. Next steerpoint estimated time of arrival (ETA)
26. Time left before reaching current steerpoint
27. Steerpoint callsign
28. Desired track angle (DTA)
29. Time late before reaching next steerpoint
30. Steerpoint estimated time of arrival (ETA)
31. Distance to go to steerpoint



## ARC Page

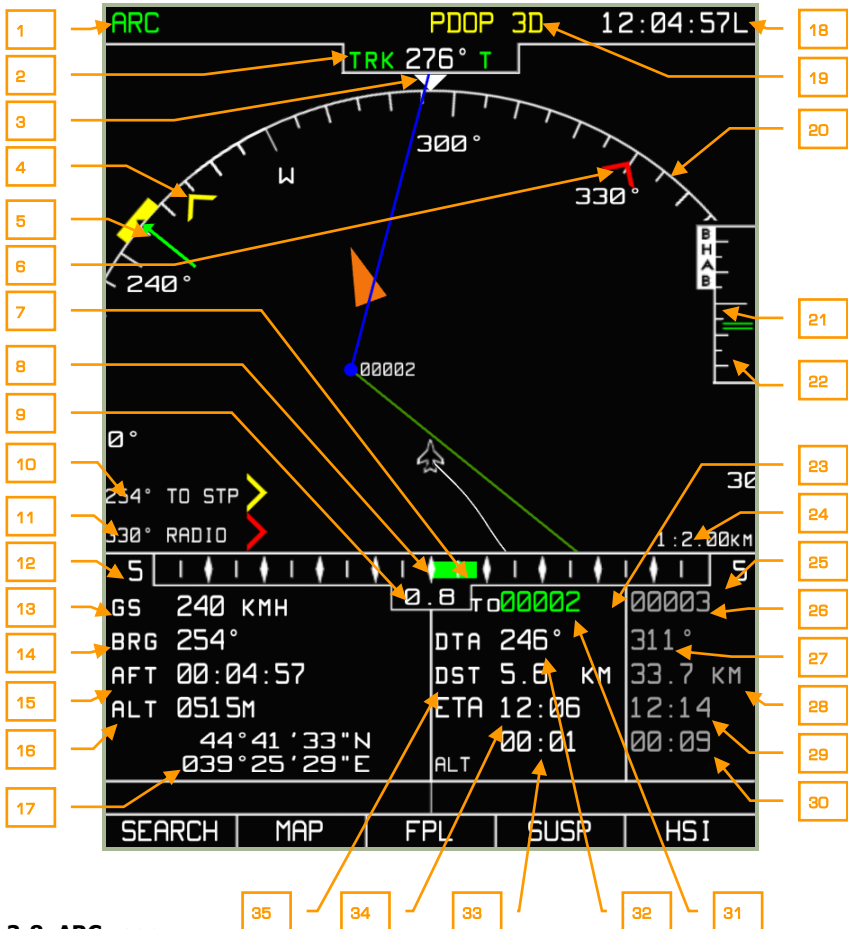

### 3-8: ARC page

1. Operating mode name
2. Current track/heading. T – true or M – magnetic
3. Actual track angle caret
4. RMI-1 - Bearing to steerpoint in this example
5. Desired track (DTK) angle
6. RMI-2 – Bearing to ADF radio beacon in this example
7. Graphical representation of cross track error (XTE)
8. XTE scale center point (on course)



9. Digital XTE value
10. RMI-1 – Digital bearing to steerpoint in this example
11. RMI-2 – Digital bearing to ADF radio beacon in this example
12. XTE scale
13. Ground speed
14. Bearing to steerpoint
15. Time enroute – actual flight time
16. Current altitude
17. Current geographic coordinates
18. Current time
19. GPS status
20. Heading scale arc
21. Vertical navigation scale
22. Graphical representation of altitude deviation from flight plan
23. Current route leg combined data field
24. Map scale
25. Next route leg combined data field
26. Callsign of next steerpoint
27. Desired track angle (DTA) for next steerpoint
28. Next leg distance
29. Next steerpoint estimated time of arrival (ETA)
30. Time late before reaching next steerpoint
31. Steerpoint callsign
32. Desired track angle (DTA)
33. Time left before reaching current steerpoint
34. Steerpoint estimated time of arrival (ETA)
35. Steerpoint distance

## HSI Page

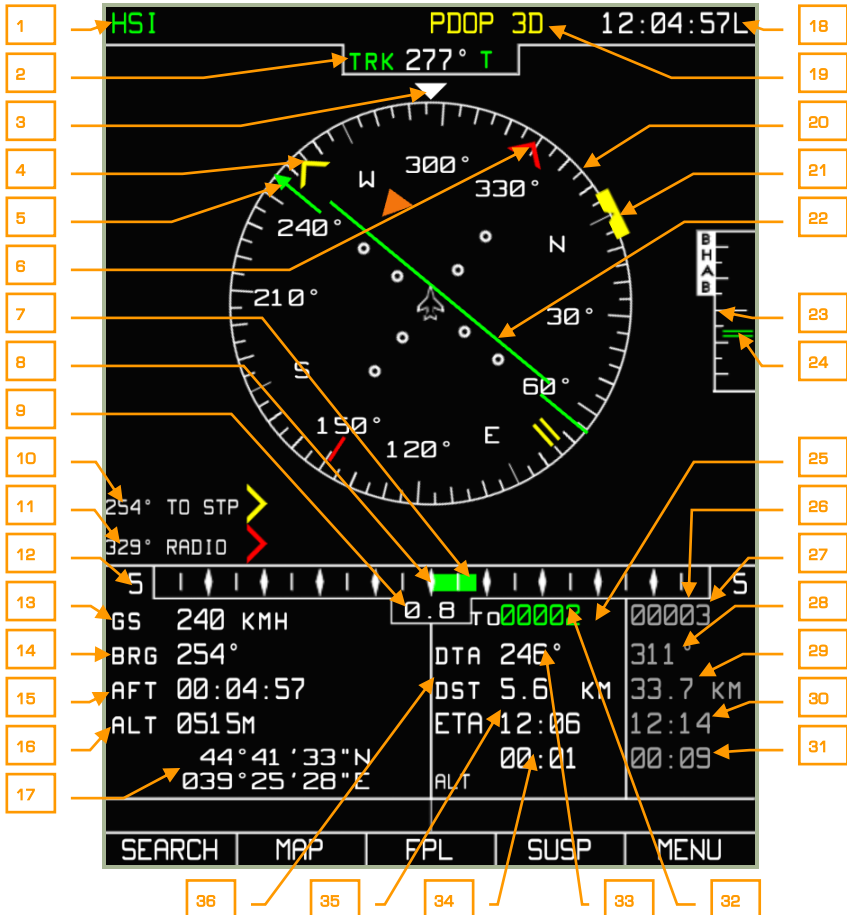

### 3-9: HSI page

1. Operating mode name
2. Current track/heading. T – true or M – magnetic
3. Actual track angle caret
4. RMI-1 - Bearing to steerpoint in this example
5. Desired track (DTK) angle
6. RMI-2 – Bearing to ADF radio beacon in this example
7. Graphical representation of cross track error (XTE)



8. XTE scale center point (no cross track error)
9. Digital XTE value
10. RMI-1 - Bearing to steerpoint in this example
11. RMI-2 - Bearing to ADF radio beacon in this example
12. XTE scale
13. Ground speed
14. Bearing to steerpoint
15. Time enroute – flight time
16. Current altitude
17. Current geographic coordinates
18. Current time
19. GPS status
20. Heading compass
21. Desired course mark
22. Graphical representation of cross track error (XTE)
23. Vertical navigation scale
24. Graphic indicator of vertical deviation from flight plan leg
25. Current route leg combined data field
26. Next route leg combined data field
27. Callsign of next steerpoint
28. Next desired track angle (DTA)
29. Next Leg distance
30. Next steerpoint estimated time of arrival (ETA)
31. Time late before reaching next steerpoint
32. Desired track angle (DTA)
33. Steerpoint name
34. Steerpoint estimated time of arrival (ETA)
35. Distance to steerpoint
36. Desired track angle

When viewing the operating mode pages for NAV, ARC, and HSI, the following items are displayed:

**Current track/heading** (digital and graphical representation). The value varies between 0 and 359 degrees and is displayed with a precision of one degree. It is



displayed over the compass scale and is supplemented with the letter (M) for magnetic or (T) for true. The value is displayed if information from the navigation sensor is available. If no heading data has been supplied, the screen displays the track value received from the GNSS sensor, or the heading value is shown in yellow. The format of the number is: DDD. E.g., 023 – course value of 23-degrees.

**Radio bearing** (digital and graphical representation). The value varies between 0 and 359 degrees and is displayed with a precision of one degree. It is displayed on the outer-circle of the static HSI and ARC mode scales. If the value is outside the display scale, only the digital azimuth value is displayed. The format of reading is DDD°. E.g., 025° – radio bearing value of 25-degrees from the aircraft's longitudinal axis. The azimuth value is shown when RMI-1(RMI-2) option is activated on the MENU/OPTIONS page.

**Desired track angle** (digital and graphical representation). The value varies between 0 and 359 degrees and is displayed with a precision of one degree. It is displayed in the flight information area and on the compass azimuth card as a green arrow and line. The format is: DDD. E.g., 043 – heading value of 43-degrees.

**Ground speed** (digital representation). The ground speed value ranges from -200 km/h to +1,500 km/h. The ground speed value is displayed with a precision of the selected measurement input device. In the case of a negative ground speed value (flying backwards), a "-"minus sign is displayed. Ground speed can be displayed in either kilometers per hour (KH) or knots (KNOTS). The unit type of measurement is selected from the MENU/OPTIONS/UNITS sub-mode from pop-up window. The format of the number is: DDDD. E.g.: 123 – ground speed value of 123.

**Cross track error (XTE)** – digital and graphical representation. The XTE value can range from 0 to 999. The readout is in the unit of measurement selected from the MENU/OPTIONS/UNITS sub-menu that can be selected from the pop-up window. It should be noted that if the XTE is less than 10 measurement units, the value is shown with a digit after the decimal point (D.D format); if it is more or equal to 10 units of measurement, it is shown in whole numbers (DDD format). E.g., 3.4 (12) – the XTE is 3.4(12) km (nautical miles). This is displayed in the flight information area.

**XTE scale.** The XTE scale provides a graphical display of up to 20 measurement units with a level of precision according to the unit of measurement. It can be displayed in kilometers, statute miles, or nautical miles. The XTE display scale is changed automatically with the flight leg.

**Altitude** (digital presentation). Altitude is displayed in the flight information area and can vary from -600 to +48,000 feet. The altitude is displayed in meters – m or feet – ft. The unit of measurement is selected from the MENU/OPTIONS/SETUP/UNITS sub-mode.

**Current leg route combined data field** (digital and graphical representation). This is located in the bottom right of the display and is visible in the NAV, ARC, and HSI operating modes. It contains several information fields that provide the following data:

- Steerpoint callsign code (STP designation)
- Desired track angle that can vary between 0- and 359-degrees, and it is displayed with a precision of one degree
- Distance to steerpoint from the current aircraft position. This value can range between 0 and 9,999. It is displayed in kilometers – km or nautical miles – nm. The unit of measurement is selected from the MENU/OPTIONS/SETUP/UNITS sub-mode

- Steerpoint estimated time of arrival (ETA) can vary from 00:00 to 23:59. The time value is displayed with a precision of one minute when in route flight and it has a precision of up to one second when in the terminal area. If it is impossible to calculate the time value, the time field displays "--:--".
- Time late in reaching steerpoint can vary between 00:00 and 23:59 (MM : SS)

**Next route leg combined data field.** Similar to the current leg information field as described above, but this field is in regards to the next leg in the route. The difference is displayed as the "S" value that shows the distance between waypoints.



### 3-10: Current and next route leg combined information fields

1. Current route leg information field
2. Current steerpoint callsign
3. Desired track angle
4. Distance to steerpoint
5. Estimated time of arrival at steerpoint
6. Estimated time late at reaching steerpoint
7. Next route leg information field
8. Next steerpoint callsign
9. DTA to next steerpoint
10. Distance to the next route leg
11. Estimate time of arrival at next steerpoint
12. Estimated late time at reaching next steerpoint

**Current geographic coordinates** (graphical and digital representation). This displays the latitude and longitude of the aircraft's current position. Display format:

- For latitude: DD°MM.MM N(S) or DD°MM'SS"N(S)
- For longitude: DDD°MM.MM E(W) or DDD°MM'SS"E(W)

DDD indicates degrees, MM indicates minutes, SS indicates seconds, and N(S), E(W) for the hemisphere. The parameters are displayed so that the longitude degrees are exactly under latitude degrees, longitude minutes are under latitude minutes, and the longitude hemisphere letter is under the latitude hemisphere letter.

**Map.** The map is displayed in the map field. The set of objects displayed on the map depends on the map scale in use.

**Map scale.** The current scale of the map is displayed on the map field. Map scale is indicated by showing the centimeter/kilometer and centimeter/mile ratio. The following scales are used: 1:100 km; 1:50 km; 1:40 km; 1:30 km; 1:25 km; 1:20 km; 1:15 km; 1:12,5 km; 1:10 km; 1:7.5 km; 1:6 km; 1:5 km; 1:4 km; 1:3 km; 1:2,5 km; 1:2 km; 1:1.5 km; 1:1.25 km; 1:1 km; 1:0.75 km; 1:0.6 km; 1:0.5 km; 1:0.3 km; 1:0.25 km; 1:0.2 km; 1:0.15 km.

**North arrow** (graphical representation). The graphical representation shows an arrow pointing towards north and has the letter "N" on it.

**Compass card** (graphical representation). This is a schematic display of a compass card with digital designations every 30-degrees and degree marks with an interval of no more than 5-degrees. It is displayed in HSI and ARC modes.

**Active route** (graphical representation). The current route is displayed in the form of a blue line with a steerpoint symbol.

#### Value display formats in the ABRIS

Parameter	Format/Symbol	Color	Note
TK	DDD	Green	Actual track angle
DTK	DDD	White	Desired track angle
HDG	DDD	White	True/magnetic heading
GS	DDDD	White	Ground speed
TAS	DDDD	White	True airspeed
XTE	D.D or DDD	White	Cross track error
XTE SCALE	DD	White	XTE scale
ALT	DDDDD M(FT)	White	Altitude
STP name	CCCCC	Green	5 character steerpoint designation
PCT	DD.D or DDDD	White	Distance to go to STP
Twpt	HH:MM:SS	White	Estimated time of arrival at STP
	HH:MM:SS	White	Time to STP OVER
LAT	DD°MM.MM N(S) or DD°MM'SS" N(S)	White	Aircraft position latitude
LON	DDD°MM.MME(W) or	White	Aircraft position longitude

	DDD°MM'SS"E(W)		
NAV, HSI. ARC		Green	Operating mode indication
NET NAV 2D 3D PDOP NAV ERROR		Yellow Yellow Green Yellow Yellow	GNSS status indication
RAIM		Yellow	RAIM status indication
		White	Map scale display

## MENU OPERATING MODE

The Main MENU contains the following information and functions:

MENU	30	09:00:13L
DATA	DATE SETUP:	22:06:2004
NAVIGATION DATA		22:06:2004
TOPO DATA		22:06:2004
COMPANY ROUTES	1	22:06:2004
ADDITIONAL INFO	2	22:06:2004
TERRAIN DATA		22:06:2004
PERF		22:06:2004
ROUTES	2	22:06:2004
METED		22:06:2004
SEA CHARTS	NO	
NAV SENSORS		
GNSS	READY	
ALTIMETER	READY	
RESOURCE	15	
S/N	BFBUVCRTCB4NYE0FCAES35J7	
VERSION SW	L012BETA	
OPTION	CTRL	PLAN
	GNSS	NAV

### 3-11: Main MENU page

- **System bar that includes:** name of the page, GNSS status, and current time
- **NAVIGATION DATA** – Navigation database and the expiration date of the database
- **TOPO DATA** – Topographic database and date that the data was created



- **COMPANY ROUTES** – Airline routes: number of recorded routes and the creation date of the most recent route
- **ADDITIONAL INFO** – User defined information and the date of the most recent modification (map points and lines)
- **TERRAIN DATA** – Terrain information and the date that the data was created
- **PERF** – Information date of the aircraft performance characteristics
- **ROUTES** – Number of recorded routes and the date that the most recent route was created
- **METEO** – Weather information and the date that the data was created
- **SEA CHARTS** – The date that the data was created, No function
- **NAV. SENSORS** – Displays the status of integrated navigational sensors (GNSS and radar ALTIMETER). To test the altimeter, press the test button on the radar altimeter gauge. This will also be checked after the K-041 self-test. This will take approximately 12 seconds
- **RESOURCES** - Servicing information that serves no role in the simulation
- **Serial number of ABRIS unit**
- **Main software version.** This will display your current version of "DCS: Black Shark"
- **Information bar on the database status:** When the aeronautical database is outdated, a DATABASE OUTDATED message is displayed in the bottom part of the page.

From the MENU page, you can select **OPTION**, **CTRL**, **PLAN**, and **GNSS** sub-modes. Below, we will discuss the functions of each of these sub-modes in detail. The right-most FSK button is used to cycle between the operating modes (MENU – NAV – ARC – HSI).

## MENU/OPTION Sub-Mode

Selected by pressing the left-most FSK button when in the MENU operating mode, the OPTION sub-mode page affects all the modes of ABRIS operation and is stored in non-volatile memory. Options can have values selected from a list or from a defined digital range.

**ATTENTION!** It is advised that you do not change option values unless you are certain of the consequences on ABRIS functionality.

Modified OPTION values are saved at the time of exiting from the sub-mode – a press of the OPTION button.

Note that when entering data for coordinates, date, time, etc., that after selecting the line item and pressing the CHANGE FSK button that the bottom of the display will change to allow you to select the field you wish to edit, and by rotating the cursor manipulator control you select the value.

OPTION		30	09:00:19L
MAIN			
MAP MOTION	RELATIVE		
MAP ORIENTATION	HEADING		
MAP SCALE	USER		
TRACK/HEADING	TRUE		
ALTITUDE	GNSS		
LOCAL TIME	+3		
TIME SETUP	09:00:19		
DATE SETUP	22-06-04		
AFT START	AUTO		
FLIGHT RECORDER	5		
WPT SEQUENCE	AUTO		
WPT OVER	5	KM	
XTE SCALE :			
MIN	5	KM	
MAX	5	KM	
RM11	TO STP		
RM12	FROM STP		
RAIM THRSOLD	100	M	
SELECT THRSOLD	AUTO		
CHECK_PSEUDORANGE	ON		
MAIN			
UNITS			
PERF			
SIGNAL			
CHARTS			
SETUP	∇	∧	CHANGE MENU

**3-12: MENU/OPTION display with MAIN sub-mode selected**

## Procedure to Change ABRIS Settings

In the OPTION sub-mode, there are five sub-modes that can be displayed by pressing the SETUP FSK button. When this button is pressed, a pop-up menu is displayed with the following options:

- MAIN – Main options
- UNITS –Set the type of measurement units that are displayed
- PERF – Enter aircraft parameters in the non-volatile memory
- SIGNAL – Adjust time intervals for alert generation alarms
- CHARTS – Adjust map display content

You may then select one of the options by pressing the up and down arrow FSK buttons or by rotating the cursor manipulator. Once a line item has been selected (boxed in the menu), press the SETPUP FSK button again or press the cursor manipulator to display the page.

To change between the pre-determined option/values, use the CHANGE FSK button; to switch from one line-option to another in the menu, use FSK buttons with the ∇ or ▲ symbols or the cursor manipulator knob. The selected function is highlighted with a box.

## MENU/OPTION/MAIN Sub-mode

The default page of the MENU/OPTION sub-mode is the MAIN sub-mode page. Using the sub-mode pop-up window, you may select MAIN to return to this page. The table below lists MAIN page options, possible values (values or formats) of options, and their effect on ABRIS functionality.

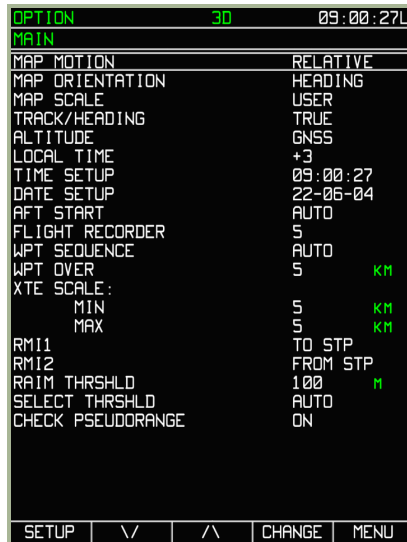

**3-13: MENU/OPTION/MAIN sub-mode page**

**List of options, possible values (values or formats) and their effect on ABRIS functionality in the MAIN sub-mode**

Option	Measurement units; format	Arguments	Effect on the ABRIS functionality
MAP MOTION		RELATIVE	The aircraft symbol is always located 20% up from the map's bottom edge
		TRUE	The aircraft symbol moves across the map and the map view update is performed automatically
MAP ORIENTATION		HEADING	Map orientation according to aircraft heading
		TRACK	Map orientation according to aircraft track angle
		NORTH	Map orientation in reference to North
SCALE		AUTO	Map display scale depends of aircraft altitude
		MANUALLY	Map scale is manually set by operator
TRACK/HEADING		TRUE	Displayed from the true meridian
		MAG	Displayed from the magnetic meridian



ALTITUDE		GNSS	From built-in GNSS sensor
		BARO	From barometric sensor
		RADIO	From radar altimeter
LOCAL TIME		+12/-12	Local time shift
TIME SETUP	HH:MM:SS		Current time
DATE SETUP	DD-MON-YY		Current date
AFT START		AUTO	Flight time logging is started when the aircraft attains a speed of 25 km/h
		USER	Flight time logging is manually initiated by the operator
FLIGHT RECORDER	Sec	1-60	Time length of flight recorder
WPT SEQUENCE		AUTO	Automatically switches from one waypoint to the next when the steerpoint has been reached
		USER	Cycling of waypoints is done manually by the operator
STP PASSED	km	0-10	Set the radius of a circle with the center being the steerpoint (STP). When this circle is crossed, a "STP PASSED" message is displayed (5 by default)
XTE SCALE MIN MAX	KM	1, 2, 5, 10, 20	Set the MIN and MAX XTE scale for automatic switching depending on the level of route error
RMI1		TO STP FROM STP VOR RADIO OFF	Symbol and digital display of the direction (yellow): from aircraft to STP from STP to aircraft to VOR to non-directional beacon nt display
RMI2			Symbol and digital display of the direction (red):

		TO STP FROM STP VOR RADIO OFF	from aircraft to STP from STP to aircraft to VOR to non-directional beacon no display
RAIM THRESHLD	M	0-9999	Set the radius of a circle with the center based on the coordinates obtained after the processing of GNSS sensor data. This is then used to calculate the probability of the aircraft's actual coordinates being within this circle
SELECT THRESHLD		AUTO/USER	Option for selecting the threshold value of RAIM calculations
CHECK PSEUDORANGE		ON/OFF	To take into account (ignore) the pseudo-range values provided by the satellites in regards to RAIM calculations

### MENU/OPTION/UNITS Sub-mode

To adjust the type of units that will be used for measurement by the ABRIS, select the UNITS option from the SETUP pop-up menu.

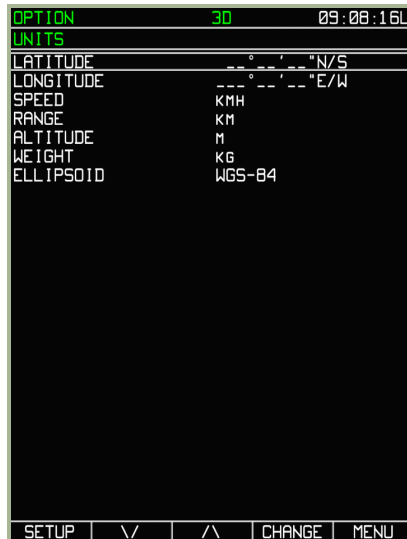

**3-14: MENU/OPTION/UNITS sub-mode page**



The effect of the option values and their permissible ranges are described in the table below.

**List of options, possible option values, and their effect on ABRIS functionality in the MENU/OPTION/UNITS sub-mode**

<b>Option</b>	<b>Arguments</b>	<b>Effect on the AMMS functioning</b>
LATITUDE/LONGITUDE	DDD*MM.MM DDD°MM SS	Display of lat-long geographic coordinates
SPEED	KMH M/S KNOTS	Use of measurement units for calculations. KMH – kilometers per hour; M/S – meters per second, and KNOTS - knots
RANGE	KM NM	Use of measurement units for calculations. KM – kilometers and NM – nautical miles
ALTITUDE	FT M	Use of measurement units for calculations. M – meters and F - feet
WEIGHT	KG LB	Use of measurement units for calculations. KG – kilograms and LB - pounds
ELLIPSOID	WGS-84/Krasowsky	Use of the ellipsoid model for calculations

## MENU/OPTION/PERF Sub-menu

The PERF sub-menu is used to adjust ABRIS flight performance parameters.

OPTION	30	09:08:39L
PERFORMANCE SETUP		
SPEEDS AND BANKS		
V1	120	KMH
V2	160	KMH
V4	120	KMH
V SPEED IN CLIMB	130	KMH
V ECONOMIC SPEED IN CLIMB	130	KMH
V CRUISING SPEED	200	KMH
V ECONOMIC SPEED	180	KMH
V SPEED IN DESCENT	120	KMH
V ECONOMIC SPEED IN DESC.	120	KMH
VY RATE OF CLIMB	5	M/S
VY RATE OF DESCENT	4	M/S
ENROUTE BANK	15°	
BANK ON APPROACH	15°	
FUEL		
TAXI FUEL	20	KG
TAKEOFF FUEL	20	KG
CRUISE CONSUMPTION	786	KG
ECONOMIC CONSUMPTION	1000	KG
SETUP	∨	∧
		CHANGE MENU

### 3-15: MENU/OPTION/PERF sub-mode page

The effect of the option values and their permissible ranges are described in the table below.

#### List of options, possible option values and their effect on ABRIS functionality (PERFORMANCE SETUP sub-mode)

Option	Measurement units (format)	Range	Effect on the AMMS functioning
SPEEDS AND BANKS			Option parameters are used for calculations of the aircraft trajectory
V1. Not used in calculations, reference only.	km/h	0–350	
V2. Not used in calculations, reference only.	km/h	0–350	
V4. Not used in calculations, reference only.	km/h	0–350	
V SPEED IN CLIMB (normal). Not used in calculations, reference only.	km/h	0–350	



V ECONOMIC SPEED IN CLIMB. Not used in calculations, reference only.	km/h	0-350	
V CRUISING SPEED, normal. Not used in calculations, reference only.	km/h	0-350	
V ECONOMIC SPEED. Not used in calculations, reference only.	km/h	0-350	
V SPEED IN DESCENT, normal. Not used in calculations, reference only.	km/h	0-350	
V ECONOMIC SPEED IN DESCENT. Not used in calculations, reference only.	km/h	0-350	
Vy RATE OF CLIMB. If the vertical speed exceeds that programmed for the leg, this value will be colored yellow.	m/s	0-50	
Vy RATE OF DESCENT. If the vertical speed exceeds that programmed for the leg, this value will be colored yellow.	m/s	0-50	
ROUTE BANK. This is used for lead turn distance calculations. The larger the value, the smaller the lead turn distance will be. This value should not exceed 60 for a helicopter.	degrees	0-60	
BANK OF APPROACH. This is used for lead turn distance calculations. The larger the value, the smaller the lead turn distance will be. This value should not exceed 60 for a helicopter.	degrees	0-60	
FUEL			
TAXI FUEL. Used to calculate remaining fuel predictions.	kg	0-100	
TAKEOFF FUEL. Used to calculate remaining fuel predictions.	kg	0-100	



CRUISE CONSUMPTION. Used to calculate remaining fuel predictions.	kg	0-1500	
ECONOMIC CONSUMPTION. Used to calculate remaining fuel predictions.	kg	0-1500	

### MENU/OPTION/SIGNAL Sub-mode

The SIGNAL page allows you to set the parameters that messages are displayed at the bottom of the ABRIS display. See the image below for a signal message example:

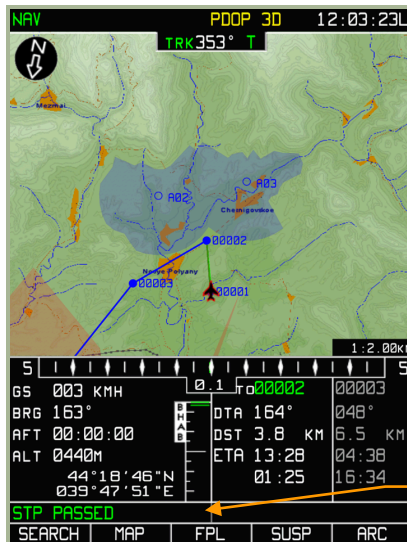

3-16: Example of SIGNAL message string

OPTION	30	09:09:26L
ALARMS		
APPROACH TO		
WPT		1 MIN
TOP-OF-CLIMB		1 MIN
TOP-OF-DESCENT		1 MIN
POINT OF TURN		1 MIN
FIR/UIR BOUNDARY		1 MIN
RESTRICTED		1 MIN
CONTROLLED		1 MIN
LIMITS		
XTE		1
CDI		20°
OBSTACLES PROT ZONE		
RADIUS		1
VERTICAL		1
TERRAIN ELEVATION		OFF
SETUP	∨	∧
	CHANGE	MENU

### 3-17: MENU/OPTION/SIGNAL sub-mode page

The effect of the option values and their permissible ranges are described in the table below.

#### List of options, possible option values and their effect on ABRIS functionality when in the SIGNAL sub-mode

Parameter	Measurement units	Range	Effect on the AMMS functioning
APPROACH TO:			
WPT	min	0-10	Time interval for warning about the approach to a route element. The message string will be displayed in yellow
TOP-OF-CLIMB CLIMB POINT. This marks the point at which a climb is initiated in the flight plan. (xx) Minutes prior to passing this waypoint that the warning message will appear.	min	0-10	
TOP-OF-DESCENT DESCENT POINT. This marks the point at which a descent is initiated in the flight plan. (xx) Minutes prior to passing this waypoint, the warning message will appear.	min	0-10	



POINT OF TURN. This message indicates the start of the turn point between waypoints. This is selected from the WPT OVER option.	min	0-10	
FIR/UIR BOUNDARY. No function	min	0-10	
RESTRICTED AIRSPACE BOUNDARY. No function	min	0-10	
CONTROLLED ATC AREA BOUNDARY. No function	min	0-10	
LIMIT:			When these values are exceeded, cautions are provided. The message string will be displayed in yellow
XTE	km	0-20	
CDI BY TRACK ANGLE	degrees	0-99	No function
OBSTACLES PROT ZONE:			
RADIUS		1	
VERTICAL		1	
TERRAIN ELEVATION		OFF	No function

## MENU/OPTION/CHARTS Sub-mode

The CHARTS page allows you to filter the information that is displayed on the moving map. Select the item you wish to edit and then use the CHANGE FSK button to toggle it on or off (+ or -).



### 3-18: MENU.OPTION/CHARTS sub-mode page

List of possible options and their effect on ABRIS when in the NAV operating mode.

Parameter	Options	Effect on the AMMS functioning
MAP	ALL SEL OFF	Aeronautical information displayed on the map. Compound option, determines option values in all items:  ALL – all "+"  SEL – selected by user  OFF – all "-"
AIRPORTS	+,-	Airports
RUNWAY	+,-	Runways
AIRPORT COMM	+,-	Communication frequency in terminal areas
ILS	+,-	Instrumental landing system
ILS MARKERS	+,-	Instrumental landing system markers
TERMINAL	+,-	Terminal non-directional radio beacon

NDB		
VHF NAVAID	+,-	Very high frequency navigation aids
NDB	+,-	Non-directional beacon navigation aid
ROUTE AIRWAYS	+,-	Route airways
FAN MARKERS	+,-	Fan markers (not implemented)
ROUTE WAYPOINTS	+,-	Intermediate route WPT's
HOLDING PATTERNS	+,-	Holding patterns
ROUTE COMM	+,-	Communication frequencies
RESTRICTED AIRSPACE	+,-	Restricted airspace
TACTICAL SITUATION	+,-	Tactical information. Wingman's symbols and target icons
POPULATION PLACES	+,-	Inhabited locality shown on the map as a built-up area
LAKES	+,-	Lakes
RIVERS	+,-	Rivers
RAILWAYS	+,-	Railways
ROADS	+,-	Roads
CABLE/PIPELINES	+,-	Cable lines/power transmission lines
TEXT	+,-	Text information and signs
LINE OBJECTS	+,-	Line objects plotted by user

The selected OPTION values are saved when the mode is exited by pressing NAV button.

## MENU/CONTROL Sub-mode

To select the CONTROL sub-mode page, press the "CTRL" FSK button from the MENU operating mode page.

The CONTROL sub-mode is indicated on the system message line with the indicator "CTRL".

From the CONTROL sub-mode page you can switch to the following sub-modes: MSG (messages), K-041 (targeting system), and DTB (database). To select the sub-page pop-up window, click on the SETUP FSK button. When the pop-up window is visible, you can cycle through sub-mode choices by using the up and down arrow FSK buttons ( $\Delta$ ,  $\nabla$ ) or by rotating the cursor manipulator. Once you have made your selection, press the SETUP FSK button again to display the page.

The selected page is indicated by its name below the system bar, under the current mode display position.

### MENU/CONTROL/MESSAGES Sub-mode



#### 3-19: MENU/CONTROL/MESSAGES sub-mode page

To switch to the MESSAGE page, select the MSG line in the pop-up menu. This page displays the last 20 messages generated by the system or received via the data link. To switch to another page, press the SETUP FSK button and the pop-up menu will appear.

### MENU/CONTROL/K-041 Sub-mode

CTRL	30	09:00:20L
K-041		
MODE	WORK	
TIME OUT	279	
LATITUDE	44°58'15"N	
LONGITUDE	038°00'51"E	
HONG	140.4	
TRK	0.0	
SPEED	0.0	
SETUP		CHANGE MENU

#### 3-20: MENU/CONTROL/K-041 sub-mode page

The K-041 page is used to check the status of the K-041 navigation and targeting system. When in "WORK" MODE, a countdown timer in seconds is displayed next to the TIME OUT field. This indicates the time until the next INS navigation fix from GNSS. Current aircraft coordinates; heading, track angle, and speed are also displayed here.

## MENU/CONTROL/DTB Sub-mode

CTRL	3D	09:00:36L
<b>ONBOARD LOADER</b>		
NAVIGATION DATA	NO	
TOPO DATA	NO	
COMPANY ROUTES	NO	
ADDITIONAL INFO	2	22:06:2004
TERRAIN DATA	NO	
PERF	NO	
ROUTES	2	22:06:2004
METEO	NO	
SEA CHARTS	NO	
<b>ONBOARD STORAGE</b>		
NAVIGATION DATA		22:06:2004
TOPO DATA		22:06:2004
COMPANY ROUTES	1	22:06:2004
ADDITIONAL INFO	2	22:06:2004
TERRAIN DATA		22:06:2004
PERF		22:06:2004
ROUTES	2	22:06:2004
METEO		22:06:2004
SEA CHARTS	NO	
SETUP	LOAD	SAVE
		MENU

### 3-21: MENU/CONTROL/DTB sub-mode page

Database information displayed on this page is similar to the display on the MENU operating mode page. Indications of information status/availability in data storage are based on the same principle.

You may save data on your PC storage device (script files) by editing these available strings:

- **NAVIGATION DATA** – Navigation database, navigation points and map objects and other navigation information.
- **ADDITIONAL INFO** – Point and Line objects entered by user.
- **ROUTES** – Routes entered by user.



## Saving Route Plans to ABRIS Database

Although you can save route plans into the ABRIS system RAM through the PLAN sub-mode pages, you can also save a route plan into the ABRIS permanent database (i.e. your hard drive). If you do so, you will have the ability to load it the next time you fly the same mission. To do so:

1. Select the MENU operating mode and press the **CTRL FSK** button.
2. Press the SETUP FSK button. This will display a pop-up menu. Using the **Δ-Δ** FSK buttons or cursor manipulator control, select the DTB (DATABASE) option and press the SETUP FSK button again.
3. Press the SAVE FSK button and this will box NAVIGATION DATA in the ONBOARD STORAGE section.
4. Press the SAVE FSK button again and this will save the route plan in the navigation database.
5. Move the cursor to ROUTES and press the SAVE **FSK button**. This will save all the flight plan data.
6. Finally, once everything is saved, press the MENU FSK button to go back to **MENU** operating page.

CTRL	TRSLD	12:00:49M
<b>ONBOARD LOADER</b>		
NAVIGATION DATA	NO	
TOPO DATA	NO	
COMPANY ROUTES	NO	
ADDITIONAL INFO	1	22:06:2004
TERRAIN DATA	NO	
PERF	NO	
ROUTES	1	22:06:2004
METEO	NO	
SEA CHARTS	NO	
<b>ONBOARD STORAGE</b>		
NAVIGATION DATA		22:06:2004
TOPO DATA		22:06:2004
COMPANY ROUTES	1	22:06:2004
ADDITIONAL INFO	1	22:06:2004
TERRAIN DATA		22:06:2004
PERF		22:06:2004
ROUTES	1	22:06:2004
METEO		22:06:2004
SEA CHARTS	NO	
SETUP	∨	∧
SAVE	MENU	

CTRL	TRSLD	12:01:15M
<b>ONBOARD LOADER</b>		
NAVIGATION DATA	NO	
TOPO DATA	NO	
COMPANY ROUTES	NO	
ADDITIONAL INFO	1	22:06:2004
TERRAIN DATA	NO	
PERF	NO	
ROUTES	1	22:06:2004
METEO	NO	
SEA CHARTS	NO	
<b>ONBOARD STORAGE</b>		
NAVIGATION DATA		22:06:2004
TOPO DATA		22:06:2004
COMPANY ROUTES	1	22:06:2004
ADDITIONAL INFO	1	22:06:2004
TERRAIN DATA		22:06:2004
PERF		22:06:2004
ROUTES	1	22:06:2004
METEO		22:06:2004
SEA CHARTS	NO	
SETUP	∨	∧
SAVE	MENU	

### 3-22: To save NAVIGATION DATA

### 3-23: To save ROUTE

This saves all flight routes to a script file that will be associated with the mission. Next time you start this mission you will be able to load the flight plan using the ABRIS **PLAN** page.

## Saving Map Points and Map Lines to ABRIS Database

To save map points and lines to ABRIS permanent storage (i.e. your hard drive), with the ability to load them the next time you fly the same mission, please do the following:

1. Select the MENU operating mode and press the **CTRL** FSK button.
2. Press the SETUP FSK button. This will display a pop-up menu. Using the **▲-▲** FSK buttons or cursor manipulator control, select the DTB (DATABASE) option and press the SETUP FSK button again.
3. On the **CTRL** page, press the SAVE button and this will display a box-cursor in the ONBOARD STORAGE section.
4. Move the cursor to the ADDITIONAL INFO entry and press the SAVE FSK button. This will save map points and lines.
5. Once everything is saved, press the MENU FSK button to go back to the **MENU** operating page.

CTRL	TRSLD	12:01:02M
<b>ONBOARD LOADER</b>		
NAVIGATION DATA	NO	
TOPO DATA	NO	
COMPANY ROUTES	NO	
ADDITIONAL INFO	1	22:06:2004
TERRAIN DATA	NO	
PERF	NO	
ROUTES	1	22:06:2004
METEO	NO	
SEA CHARTS	NO	
<b>ONBOARD STORAGE</b>		
NAVIGATION DATA		22:06:2004
TOPO DATA		22:06:2004
COMPANY ROUTES	1	22:06:2004
ADDITIONAL INFO	1	22:06:2004
TERRAIN DATA		22:06:2004
PERF		22:06:2004
ROUTES	1	22:06:2004
METEO		22:06:2004
SEA CHARTS	NO	
SETUP	∨	∧
SAVE	MENU	

**3-24: Saving map points and lines in ADDITIONAL INFO**

## MENU/PLAN Sub-mode

The **PLAN** sub-mode is used for route planning and correction and is a useful tool for when you need to modify the flight plan after new intelligence on enemy positions becomes available. **PLAN** sub-mode is selected by pressing the **PLAN** FSK button on the main **MENU** operating mode page.

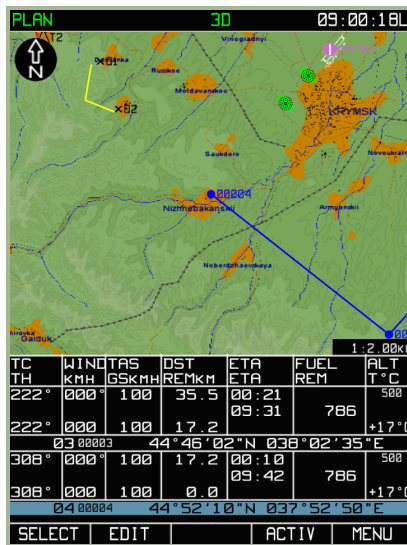

### 3-25: MENU/PLAN sub-mode page

After the **PLAN** sub-mode FSK button has been selected, the ABRIS display will appear as shown above. Note that the display is static and may not accurately represent the aircraft's current position and state. It may be helpful to think of this as an in-cockpit mission editor.

## Route Handling

One of the most important functions of the **PLAN** sub-mode is the ability to edit and create new flight plans in ABRIS. **PLAN** mode offers the following functions to support this:

- Creation of a route in either manual or automatic mode with the use of waypoint (WPT) callsigns.
- Storage of routes in the ABRIS database with the capability to save, load, and delete routes from the database.
- Automated route calculations based on entered parameters: true airspeed, altitude, weather information, distance between waypoint legs, fuel level, and fuel flow data.

Enhanced ABRIS capabilities are provided by the implementation of a number of additional functions:

- Manual input of WPTs not available in the loaded ABRIS database.
- Manual input of line type objects: points, boundaries, area object contours, etc.

A route created in ABRIS consists of an airfield departure point, a set of waypoints, and an airfield destination (terminal) point. To provide flight plan (FPL) calculations, the route may include TAS data, flight altitude, weather information, fuel loading, and fuel flow in different sortie phases.

After pressing the PLAN FSK button, the main **PLAN** sub-mode page will display the active route.



3-26: MENU/PLAN sub-mode

### Unload Active Route

To unload the current route displayed on the ABRIS and create a new route, press the **SELECT** FSK button and then select the **UNLOAD** option from the pop-up menu. In doing so, you will erase the route that was created in the mission editor. The **DRAW** FSK button will now be visible next to the **SELECT** FSK button and provide you the ability to draw a new flight route. It is important to understand that you must unload the current route before creating a new one.



**3-27: UNLOAD route selected from pop-up menu**

**3-28: View of the PLAN sub-mode after unloading of current plan**

### Manual Waypoint Entry

A route consists of two or more waypoints joined sequentially. As such, we'll first need to learn how to place waypoints. After unloading the current plan, press the **DRAW** FSK button. The ABRIS map will now display a green-colored box . In the example below, the box is centered over the starting airfield. Additionally, a grey field with information appears in the flight information area.



**3-29: MENU/PLAN display when waypoint entry mode is entered**

The new waypoint information field (grey box) includes the following data:

1. **01** – Waypoint number in the route. This number is automatically assigned.
2. **NEW STP** – A conventional name of the steerpoint is added to the route; a yellow color indicates that if the steerpoint is included in the route, the field value will have to be changed (or it will be changed automatically). This is an editable field.
3. **Waypoint-over option**. Allows three options to determine how steering information will be provided between waypoints (FBY, OVR, or FIN)
4. **MVR** – The magnetic declination value for the area where the active marker is positioned.
5. **Active marker's coordinates**. Displayed as latitude and longitude values, this field indicates the coordinates on the map of the green box marker.

To add a waypoint to a route, press ADD button:

Before performing this operation, it may be necessary to change the coordinates of the waypoint to be entered. In doing so, it may be best to change the scale of the map by pressing the SCALE+ or SCALE- FSK buttons the necessary number of times. The current map scale value is displayed in the bottom right corner of the map.

After the map scale has been appropriately set, use the cursor manipulator to move the cursor to the map coordinate/object where you wish to place the waypoint. In the case of a first waypoint, this should be an airfield. Left click on the cursor manipulator knob to toggle between horizontal marker movement and vertical marker movement. Note that when the marker is moved that the coordinates are updated on the left side of the flight information area. When objects already plotted on the map are used to place a waypoint, the marker should be placed on top of the map object to be used (waypoints, airdromes,

beacons, etc.). A precise placement is not required (the available object will be entered into the waypoint input field by pressing the ADD FSK button), but the marker center is required to be over the map object.

After a waypoint has been added to the route, the following options are possible:

If there is no map object point under the active marker when the waypoint was created, the WPT conventional number in the route plan is assigned automatically and cannot be changed. Within the flight information area, a white colored box indicates the field to be edited; by default it is the waypoint name field. Information field values can be changed using the cursor manipulator knob. To cycle between the fields to be edited, press the ►► FSK button:

- **WPT name field** – To edit this field, rotate the cursor manipulator; right clicking the knob cycles to the next character space. Cycling to a different field enters the name.
- **WPT OVER** option – Determines the passing order of the aircraft turn. The permissible field values and their characteristics are shown in the table below.

**Values of WPT OVER option field**

Displayed symbols	Value in the route calculations
FBY	Mandatory passing of a WPT with a FIN turn lead distance
OVR	Mandatory passing over a WPT along the previous route leg track
FIN	Mandatory passing over a WPT along the following route leg track

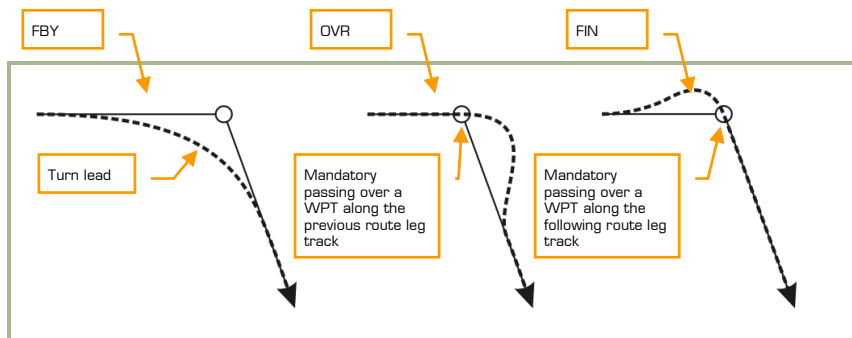

**3-30: Examples of the WPT OVER options**

- **Magnetic declination field** – The value can be changed by using the cursor manipulator control and the permissible value is +/- 90.
- **WPT coordinate field** – This value is automatically changed by using the cursor manipulator control.

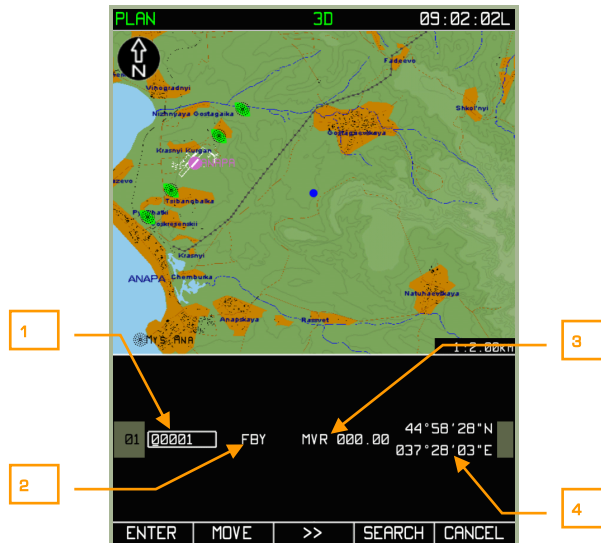

**3-31: View of MENU/PLAN display after a WPT is entered at an arbitrary map point**

1. WPT name
2. WPT OVER option
3. Magnetic declination field
4. WPT coordinates

When there is an aeronautical point under the active maker:

When the marker has been placed over a map object creating a waypoint, the waypoint information fields have values similar to those described above, the difference being an additional field: AERONAUTICAL POINT TYPE. This displays the object type stored in the ABRIS database as white symbols against black background next to the WPT OVER field. The possible fields and their characteristics are shown in the table below:

#### AERONAUTICAL POINT TYPE data fields

Displayed symbols	Value in the route calculations
<b>A</b>	Airport
<b>N</b>	Non-directional radio beacon (NDB)
<b>V</b>	VOR
<b>I</b>	Unmarked aeronautical point or an aeronautical point determined by the operator





### 3-32: MENU/PLAN display after a waypoint is created over a map point

Only the WPT OVER options and MAGNETIC DECLINATION data fields are active in this case. The values of the other fields are determined by values stored in the aeronautical database for the map point: WPT name, AERONAUTICAL POINT TYPE, GEOGRAPHIC COORDINATES.

#### To complete the procedure for adding a WPT to the route:

Once the waypoint has been created, press the **ENTER** FSK button. After this is done, the screen will display a blue ● WPT marker on the map. To cancel addition of a WPT to the route, press the **CANCEL** FSK button.

### Enter Waypoint by Callsign

The ABRIS includes a database of navigational points that can be fed to the **PLAN** sub-mode using the **SEARCH** FSK button. The **SEARCH** FSK is available from the **PLAN** sub-mode after you have added a waypoint to a route.

A search in the navigational point database is made according to callsign. To enter a callsign search, press the **SEARCH** FSK button and then enter a callsign name in the field. As the first character of the WPT callsign is entered (by default, a 00001 string is used for the callsign), the field is cleared. To switch to the next character position, right click the cursor manipulator.

Attention! To correctly select the WPT from the database, it may be necessary to enter ALL the callsign characters!

If you have switched from the first character position to the next without changing it, the field you are editing will be left intact. When a WPT is selected in this manner, only the WPT OVER field can be edited in the flight information area. Press the **SEARCH** FSK button a second time to save the WPT.

**Use the following procedure to add a WPT by use of callsign:**

1. Press the **DRAW** FSK button and the screen will display the map with a green colored box marker on it - , a grey field with WPT information appears in the flight information area.
2. Press the **ADD** FSK button after moving the marker with the cursor manipulator control. If there is a navigational point under the marker, it will be automatically included in the route. In case of an unintentional WPT input, press the **CANCEL** button.

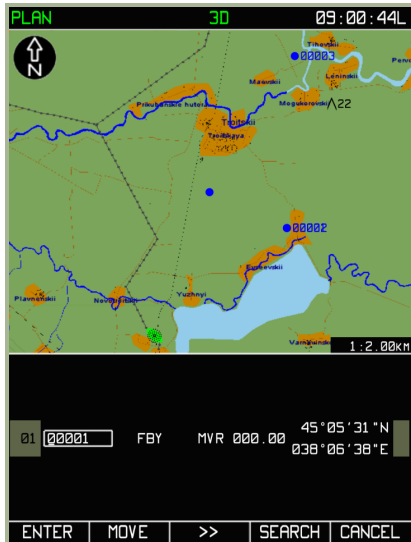

**3-33: MENU/PLAN sub-mode with available SEARCH function**

3. Press the **SEARCH** FSK button and in the WPT (name) callsign field (box with blinking cursor) enter a full callsign.

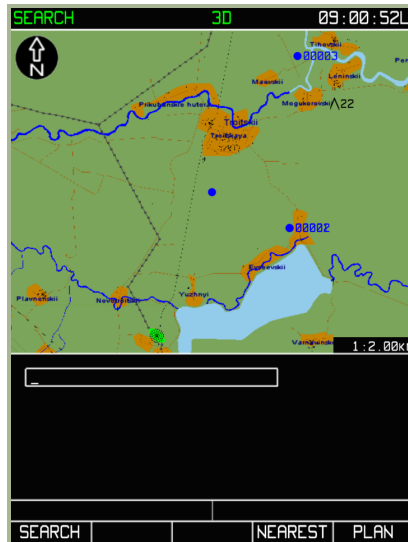

**3-34: Callsign input in search mode**

4. Press the **SEARCH** FSK button again. There will be two possible results:
  - The navigational point was found and the map view will center on that location. Careful: there may be several points with the same callsign in the database but with differing geographic coordinates or aeronautical point type. In such a case, press **SEARCH** again and try to find the desired point.



**3-35: MENU/PLAN sub-mode display after successfully completing a navigational point search by use of callsign**

- The navigational point was not found. In this case, the screen displays “NOT FOUND” message. The appearance of the message could be the result of the callsign not existing in the navigational point database or an error in the callsign input.

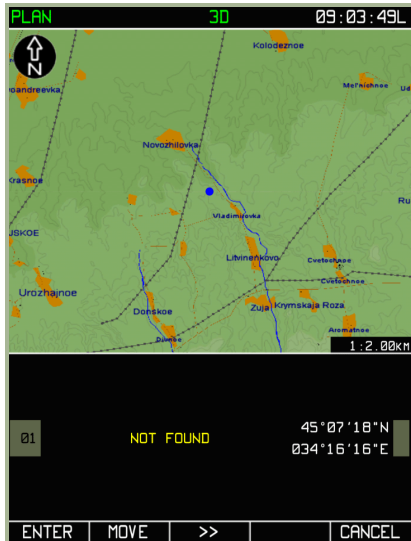

**3-36: MENU/PLAN sub-mode display when callsign is not found in database**

5. To complete the procedure of adding a WPT, press the ENTER FSK button.

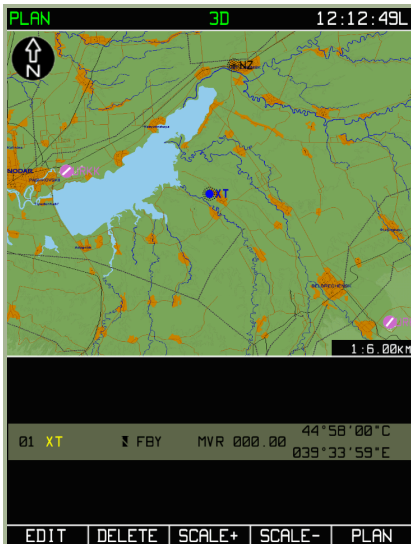

**3-37: MENU/PLAN sub-mode after waypoint has been saved**

### Editing a waypoint's properties:

After you have created a waypoint and entered it, you can always go back and edit its parameters. To do so, select the waypoint and press the **EDIT** FSK button. This will display the pop-up window; from this, select the **EDIT** option by rotating the cursor manipulator to the **DRAW** option. Upon doing so, you will be returned to the editing page for that waypoint.

In addition to editing the initial properties, you can also select **SPEED**, **VNAV**, **METEO** and **FUEL** from the **EDIT** sub-menus.

When you have a route consisting of multiple waypoints, you may rotate the cursor manipulator to cycle between the waypoints. The currently selected waypoint will have its entry line shaded in blue.

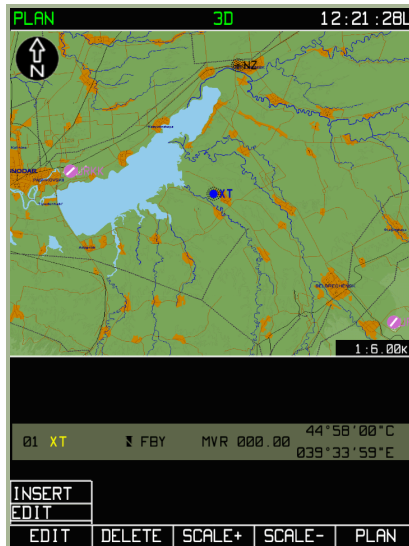

3-38: MENU/PLAN/EDIT sub-mode

### Editing a waypoint's location:

If you wish to adjust the coordinates of a waypoint, use the following procedure:

- From the main **PLAN** sub-mode page, press the **EDIT** FSK and then select the **DRAW** option from the pop-up menu.
- Select the waypoint you wish to edit (rotate cursor manipulator control when you have more than one waypoint in the route).
- Press the **EDIT** FSK button and then select the **EDIT** sub-mode option.
- Press **MOVE** FSK button. At this stage, a cursor in the form of a green box will appear over the waypoint you have selected .



- Use the cursor manipulator to adjust the coordinates of the waypoint. Note that green lines will connect the new waypoint position to the waypoints before and after it in the route.
- When you adjusted the waypoint's location to your satisfaction, press the **ENTER FSK** button to finalize the adjustment.

The coordinates of new position WPT and ranges are calculated automatically.

If it is necessary to correct parameters of another route point (leg), repeat the procedure detailed above.

Note that this function will not work for waypoints assigned to airfields or beacons

### **Deleting a waypoint:**

After you have added a waypoint to a route, you can always delete it. To do so:

- From the **PLAN** sub-mode page, press the **EDIT** FSK and then select the **DRAW** option from the pop-up menu.
- Select the waypoint you wish to delete (rotate cursor manipulator when you have more than one waypoint in the route).
- Press the **DELETE** FSK button to remove the selected waypoint from the route.

After this is done, the selected waypoint point will be deleted from the route and its graphic representation will disappear from the map. The graphic representation of the route will change to suit the new succession of waypoints.

If it is necessary to delete several route points, repeat the operations described above.

### **Inserting a new waypoint in route:**

Whereas a WPT is a single geographic point, a route is a collection of two or more waypoints linked together sequentially. Each WPT is represented by a blue dot and connecting them will be a blue line. This is the course line between them.

One you have created your first WPT as described above, you now need to add a second to make an actual route. To do so, first press the **EDIT** FSK button from the **PLAN** sub-mode page and then select **DRAW** from the pop-up window. Next, press the **EDIT** FSK button and then select the **INSERT** option from the pop-up menu. This will allow you to add a waypoint in succession after the waypoint you currently have selected.

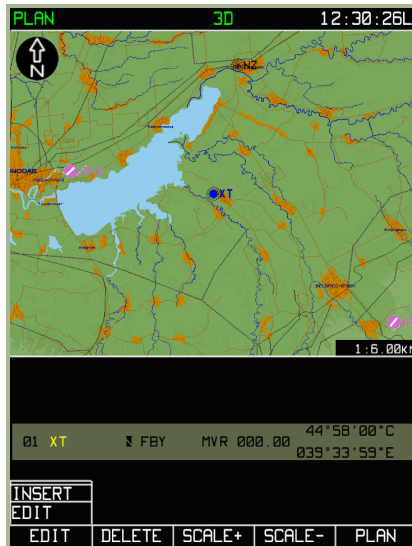

### 3-39: MENU/PLAN/EDIT sub-mode to add a new waypoint to route

After you select the **INSERT** sub-mode option, you will see a green box over the currently selected waypoint. Use the cursor manipulator control to move the box. The location of this box will determine the coordinates of the new waypoint you are inserting into the route. If the new waypoint is entered in the middle part of a route, the previous waypoint will shift upwards. Note that a blue line will connect the current waypoint to the new waypoint. When you have placed the marker at the desired location of the next waypoint, press the **ADD FSK** button.

After having placed the new waypoint, you can then assign it its properties.

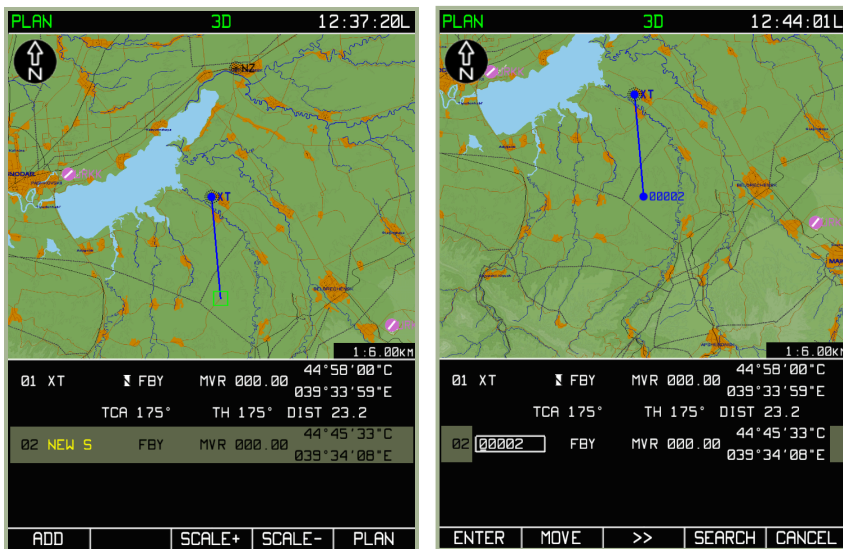

**3-40: Inserting new WPT in the MENU/PLAN sub-mode**

**3-41: Editing new WPT in the MENU/PLAN sub-mode**

Pressing the **ENTER** FSK will return you to the initial waypoint insertion list. You may rotate the cursor manipulator to cycle selection of all the waypoints in the route. In this manner, you may repeatedly add waypoints to a route to create a route plan from start to finish. You can also go back at any time and select any of the route waypoints for edit.

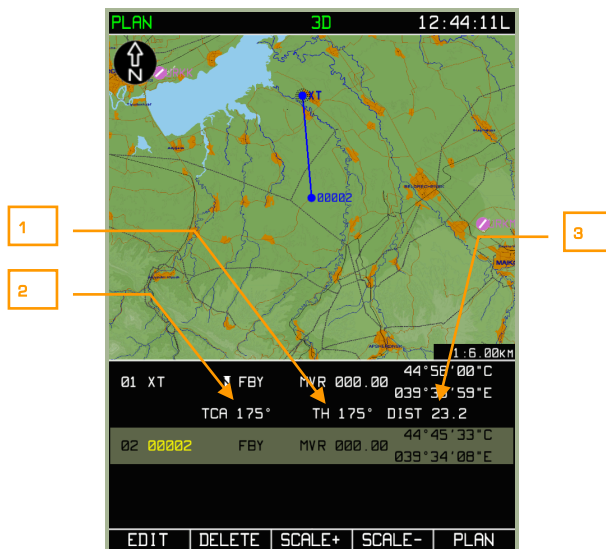



### 3-42: MENU/PLAN sub-mode view after WPT has been added to route

When there is more than one waypoint in a route, the ABRIS will provide additional information concerning legs and the entire route.

1. ACFT True Heading on the route leg - TH
2. True Track Angle - TCA
3. DiStance between the WPT - DST

When the next WPT is entered in the middle part of the flight information, the previous one is shifted upwards. An additional information line appears between them and contains TCA, TH, and DST.

### Return to the Initially Activated Route

If the route is altered during a sortie (the mission editor-created route is corrected or replaced with a new one), and it becomes necessary to return to the mission editor route, you can use the following procedure:

- Select the **PLAN** sub-mode page and press the **SELECT** FSK button
- From the pop-up menu, select the **REVISE** option and press the **SELECT** button again
- Press the **ACTIV** FSK button



### 3-43: Return to the Initially Activated Route

## Editing a waypoint's data for route calculations

In addition to setting a waypoint's initial properties such as name, WPT OVER type, magnetic declination, point type and coordinate, you may also enter data to assist in route calculations. This includes:

- Time of departure from the IWP and the aircraft's true airspeed on the route legs.
- Flight altitude on the route leg (flight altitude on the route leg and distance from/to the WPT).
- Weather information on the route legs (wind speed and direction, air temperature on the planned flight level).
- Data on the amount of fuel and fuel flow on the route legs.

## MENU/PLAN/SPEED Sub-mode

For prepared route legs, press the **EDIT** FSK button from the **PLAN** sub-mode page, and from the pop-up menu, select the **SPEED** option. Then press the **EDIT** FSK button. The screen will now display information fields containing data on each of the flight legs:

- Waypoint number that marks the start of each leg
- Waypoint callsign
- True airspeed on the flight leg
- Route leg length
- Time enroute on the route leg
- Estimated time of arrival at each waypoint



3-44: MENU/PLAN/SPEED sub-mode menu



3-45: Entering the time of departure from the IWP and true airspeed

1. TAS
2. WPT callsign
3. WPT number
4. Leg length

5. WPT time flight
6. Departure time / Predicted WPT OVER time

To cycle between legs, rotate the cursor manipulator. When you have selected the leg you wish to edit, press the **EDIT** FSK button. To change the value of the departure time for the IWP or TAS on the route leg, rotate the cursor manipulator (to select a parameter, press the knob axially or use the **EDIT** button). To save the leg edits, press the **ENTER** FSK button. To exit from the **SPEED** sub-mode, press **PLAN** FSK button.

The automatically calculated values are re-calculated after each value change. As the TAS value is changed on one of the route legs, the ETA value is automatically adjusted for all of the later legs.

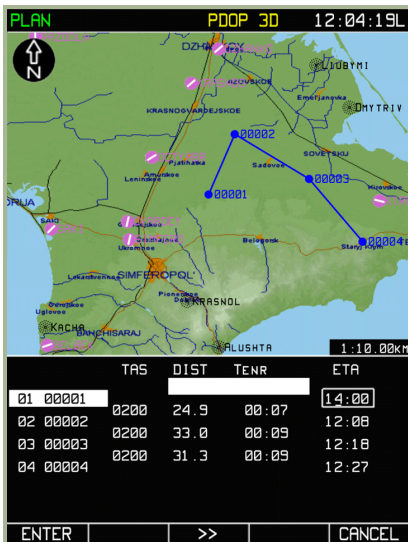

3-46: Entering time of departure from the IWP

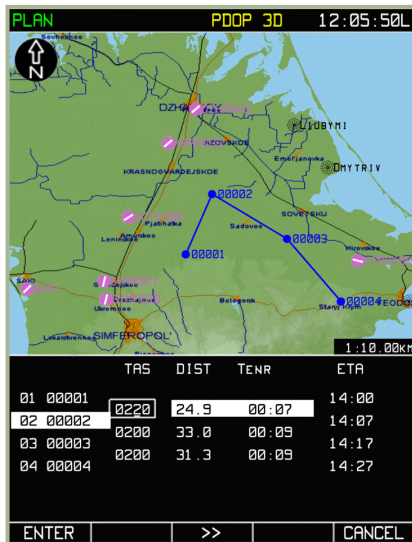

3-47: Setting TAS values for 01 to 02 leg

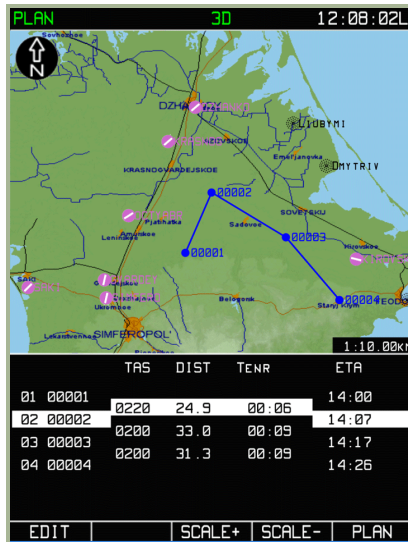

3-48: View SPEED sub-mode with values entered for time of departure and TAS for route legs

## MENU/PLAN/VNAV Sub-mode

This sub-mode allows you to set the aircraft's leg vertical airspeed (in meters per second  $-V_y$   $m/s$ ), altitude of leg, (in meters -  $H_m$ ), and the leg distance to/from the waypoint (in kilometers  $-S_{km}$ ).

To access the **VNAV** sub-mode page, press the **EDIT** FSK button from the main **PLAN** sub-mode page and select the **VNAV** option from the pop-up menu. Press the **EDIT** FSK button again to enter the page. The bottom part of the screen will display information boxes for entering the altitude values and distances from waypoints.

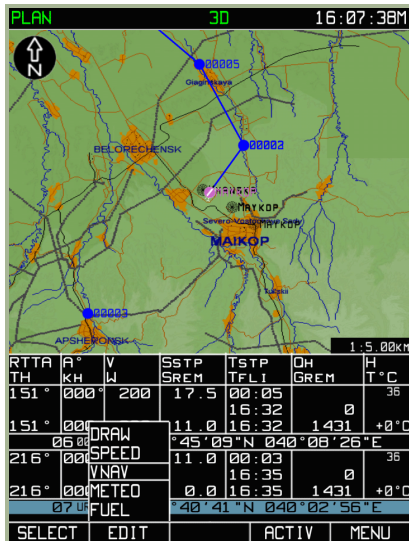

3-49: Selecting MENU/PLAN/VNAV sub-mode



### 3-50: MENU/PLAN/VNAV sub-mode page

- Waypoint altitude
- Distance from/to WPT. ("-" to reach the altitude "S" km before the WPT, "+" to reach the altitude "S" km after the WPT OVER)
- WPT callsign
- WPT number
- Vertical speed

The information field displays the following boxes:

- Information** – Waypoint number and callsign
- Entered by the operator** – Distance from waypoint and route leg altitude
- Automatically calculated from entered values** – Aircraft vertical speed

As values are entered, the ABRIS automatically plots a rectilinear profile of climb or descent from the leg start WPT to the leg end WPT. The start point is the initial leg WPT where the flight altitude is set ( $H_M$ ). The end point is the terminal leg WPT, the distance from/to it ( $S_{km}$ ) and the sign of this distance ("-" to reach the altitude "S" km before the WPT, "+" to reach the altitude "S" km after the WPT OVER) is taken into account. A profile with a permanent gradient is plotted from the start point to the end point. After pressing the **ENTER** FSK button, the ACFT VERTICAL SPEED -  $V_y$  m/s, is automatically calculated and displayed – white if the value does not exceed the rated value set in the ACFT PERF and yellow if the value is exceeded.

The entered flight information is used in the VERTICAL NAVIGATION sub-mode for calculating the CLIMB and DESCENT points. This sub-mode is available in-flight from the FPL mode.

Use the following procedure for entering values:

To enter  $S_{km}$  and  $H_M$  values, use the cursor manipulator to select a line for editing, either press the cursor manipulator axially or press the **EDIT** FSK button. To switch to the next character, press the cursor manipulator axially, and to start editing of the next field, press the **▶▶** FSK button. The value is recorded in the plan after pressing the **ENTER** FSK button. After this is done, the flight altitude fields are filled in automatically, from the current field to the route terminal point.



### 3-51: Entering flight altitude values for the first waypoint

### 3-52: Results of automatic filling in of flight altitude fields on the route legs

This mode enables you to reach an altitude (at a constant vertical speed) over several waypoints without using a stepped process. To reach an altitude at a constant vertical speed, follow these steps:

1. Enter a value in the  $H_M$  field of the route leg that you wish to start the altitude planning from.
2. Use the cursor manipulator to switch the active field to the next leg and press the **CLEAR** FSK button. Perform this operation successively for the entire intermediate route legs that require altitude planning.
3. For a route leg where the set altitude will be reached, enter its value.
4. Press the **ENTER** FSK button and the screen will display the calculated flight altitudes for the route legs and vertical speeds.





**3-53: Clearing flight altitude values for the intermediate altitudes**

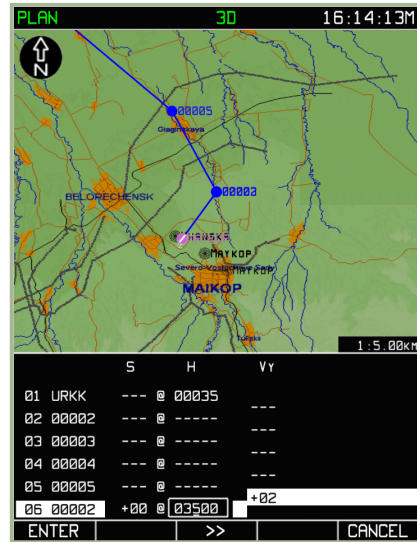

**3-54: Input of the final desired altitude**

This will result in calculating the vertical speed needed to reach a desired altitude. If the aircraft PERF values are exceeded, the altitude values will be shown in yellow.

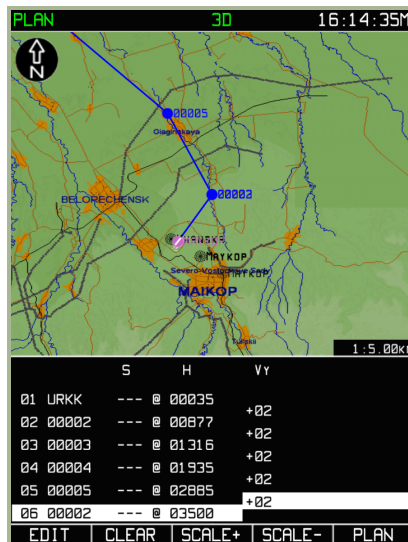

**3-55: Results of automatically reaching the set altitude without steps**

## MENU/PLAN/METEO Sub-mode

This PLAN/METEO sub-mode is intended for entering weather data along the planned route. The entered values are used to calculate the predicted aircraft ground speed and flight time between legs of the route. To view this sub-mode, select the PLAN sub-mode and press the **EDIT** FSK button. Select **METEO** from the pop-up menu and press the **EDIT** FSK button.

RTTA	A°	V	SSTP	TSTP	QH	H
TH	KH	W	SREM	TFLI	GREM	T °C
				16:00	786	.34
				1234		+20 °C
DRAW			02°05'N	039°05'45"E		
061°	00°	SPEED	23.9	00:14		500
		VNAV		16:14	786	
061°	00°	METEO	00.1	16:14	1234	+17 °C
02		FUEL		07°20'N	039°26'24"E	
SELECT	EDIT			ACTIV	MENU	

3-56: Selecting the METEO sub-mode from MENU/PLAN sub-mode

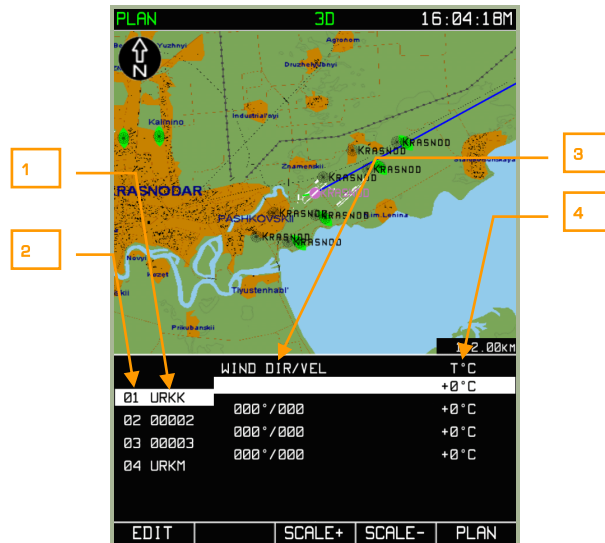

### 3-57: MENU/PLAN/METEO sub-mode page

1. WPT callsign
2. WPT number
3. Wind direction / speed
4. Ambient air temperature

In the data fields, you may enter the wind direction, wind speed, and ambient air temperature T°C for each of the route legs. To edit a route leg, select a waypoint with the cursor manipulator and press the **EDIT** FSK button (or axial press on the cursor manipulator knob). To change the values of a leg, you can use the **►** FSK button to cycle between fields, press the cursor manipulator to cycle between characters within the field, and then rotate the cursor manipulator to adjust the character values. Once you have made all your edits to a leg, press the **ENTER** FSK to enter your changes.

To exit from the **METEO** sub-mode, press **PLAN** FSK button.

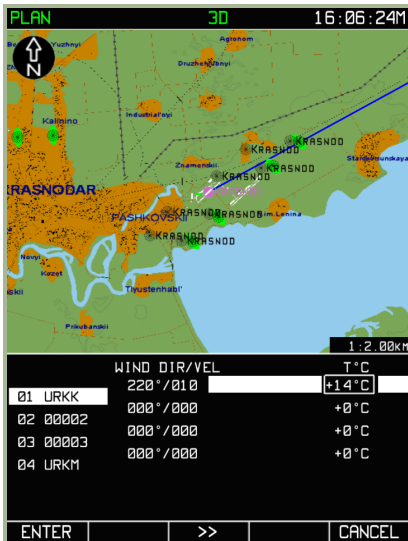

3-58: Example of entering ambient temperature value



3-59: Result of modifying METEO data value in MENU/PLAN/FUEL Sub-mode

## MENU/PLAN/FUEL Sub-mode

The FUEL sub-mode allows you to input data on the fuel quantity and fuel flow during the flight along the planned route. The entered values are used to calculate remaining fuel after each leg in the route is passed. To view this sub-mode, press the **EDIT** FSK button from the main **PLAN** operating page, and then select the **FUEL** option from the pop-up menu. With **FUEL** selected, press the **EDIT** FSK a second time.

The flight information area displays leg-lines containing the following fields:

- **Information:** WPT number, WPT callsign, and time enroute on the leg.
- **Editable:** Fuel quantity at the IWP (REM kg - kilogram) and predicted fuel consumption on the route legs (FUEL CON - kilograms per hour).
- **Calculated:** Predicted fuel remaining when passing a WPT (REM kg - kilogram).

With the input of data on the amount of fuel at the IWP and predicted fuel flow on the first leg of the route, the following calculations are performed:

- All the FUEL CON boxes of all the route legs are automatically filled in.
- Fuel remaining is calculated for the passing of each WPT.

If it is necessary to specify the predicted fuel flow for the route legs, the remaining fuel for each WPT cannot be edited. A yellow color is used to display zero calculated values of fuel remaining. Rotate the cursor manipulator to select a leg-line and then press the **EDIT** FSK button to enter values. To cycle characters within an edit field, right click the

cursor manipulator and rotate it to cycle character values. When you have finished your edits to a leg-line, press the **ENTER** FSK button to enter your changes. To exit the **FUEL** sub-mode, press the **PLAN** FSK button.

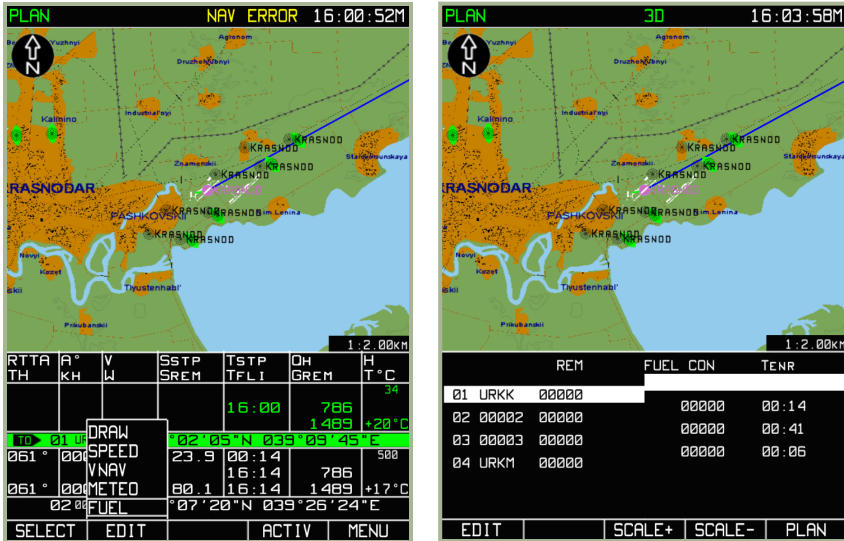

3-60: Selecting FUEL sub-mode from MENU/PLAN/FUEL

3-61: FUEL sub-mode

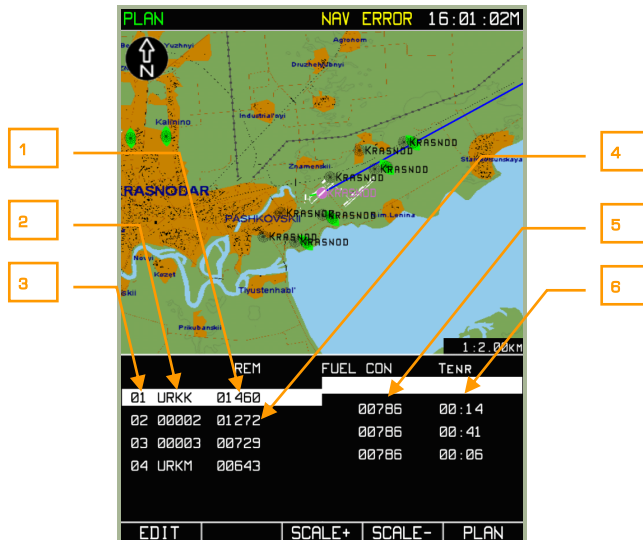

3-62: MENU/PLAN/FUEL sub-mode after being updated with fuel quantity and predicted flow



1. Fuel quantity in the IWP
2. WPT callsign
3. WPT number
4. Predicted remaining fuel residual after passing of WPT
5. Predicted fuel flow on the route leg
6. Time enroute on leg

### **Saving a route to ABRIS RAM**

ABRIS RAM stores a route consisting of:

- Route WPT's (IWP's, FWP's, WPT's)
- True airspeed values, flight altitudes, fuel quantity, and fuel flow per leg

Use the following procedure to save a route:

1. When you wish to save a newly created or modified route, press the **SELECT** FSK button from the **PLAN** sub-page.
2. By rotating the cursor manipulator knob, highlight the **SAVE** option and press the **SELECT** FSK button.
3. At the bottom of the display, "NAME OF ROUTE" is shown. Below that is a field in which you can enter a name for the route.
4. Use the cursor manipulator,  $\Delta$ ,  $\nabla$  buttons and  $\triangleright$  to enter the ROUTE NAME as you wish.
5. Press the **SAVE** FSK button to commit the route to the ABRIS RAM memory. The screen will switch to the **PLAN** sub-mode page where a saved navigation table appears below the map. The active marker will be positioned on the IWP.



## Route activation (ACTIV)

A newly created, modified, or loaded from the database route needs to be ACTIVATED if it is to be used in current navigation calculations.

To switch from planning (PLAN) mode to flight mode (the mode whereby the current navigational information is calculated, displayed and outputted to the interfaced systems, after the route has been prepared and loaded), you should:

1. In the **PLAN** sub-mode page press, press the **ACTIV** FSK button. The ABRIS will then switch to the **NAV** operating mode.
2. The **NAV** page displays the following:
  - Current route on the map (initial leg with the IWP).
  - Current navigational parameters in the left part of the flight information area.



3-66: MENU/PLAN sub-mode view prior to activation

## Route Loading

The ABRIS database can store routes prepared by operators using the ABRIS while on board the aircraft. To load a route, use the following procedure:

Select the **PLAN** sub-mode and press the **SELECT** FSK button. A pop-up menu containing available route handling operations will appear over the button.

Attention! Before loading a route, be sure to use the **UNLOAD** option to remove the current route. Remember to press the **SELECT** FSK button after selecting **UNLOAD** to clear the route.

After the current route has been unloaded, use the cursor manipulator to highlight the **LOAD** option and then press the **LOAD** FSK button. The screen will display a list of



routes saved in the database. Note that routes can only be saved to the database through the MENU/CONTROL/SETUP/DTB process discussed earlier.

Use the cursor manipulator to highlight the name of the route to be loaded.

Press the **LOAD** FSK button and the route will be loaded from the ABRIS database.

After the route has been loaded for viewing, the IWP will be centered on the map, and in the route table located below the map, the line corresponding to the IWP and the first route leg will be highlighted. When the cursor manipulator is rotated, the next WPT will be selected and this will move the center of the map to correspond with that waypoint location.

**Attention!**  
Before using a loaded route as your operating one, remember to first activate it.



**3-67: Selecting MENU/PLAN/LOAD sub-mode**

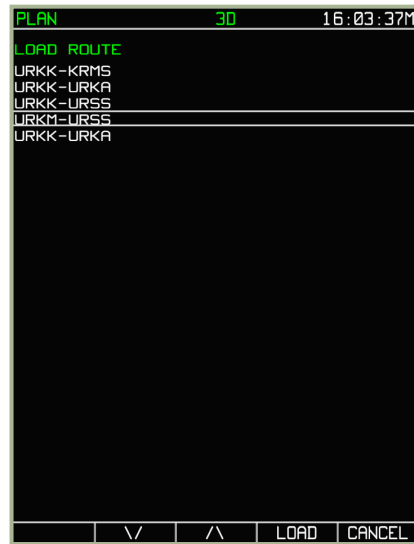

**3-68: Selecting route to load**



**3-69: PLAN sub-mode after route is loaded**

## Route Viewing

A prepared or loaded route is always available for viewing. To do this, use the following procedure:

1. Press the **PLAN** FSK button when in the **MENU** operating mode. If the viewing is done when a route is active, the active plan is automatically loaded for viewing.
2. To view waypoints included in the route, move the active marker by using the cursor manipulator control. It is possible to review the entire route, waypoint by waypoint (from the route initial to the route terminal point), checking the following for each route leg:
  - Point location on the map
  - Topographic and aeronautical terrain features along the route
  - Text (numeric) parameters of the route points and legs

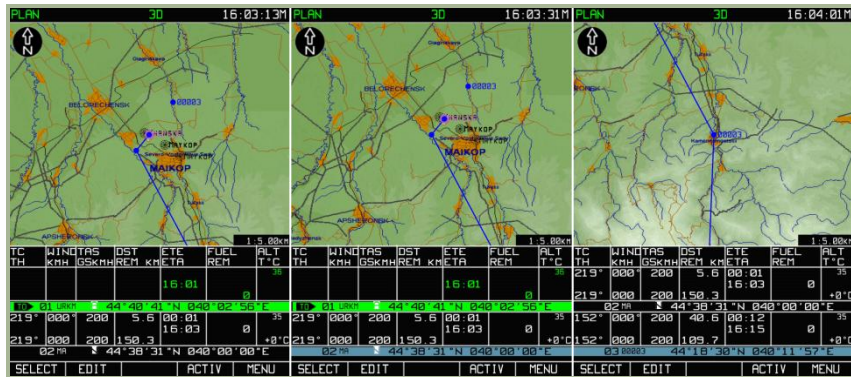

### 3-70: Viewing first three waypoints of route

In this mode, it is possible to edit the route. If the route being viewed has been edited, it is advisable to record a new route version to the system database.

To exit the **PLAN** sub-mode, press the **MENU** FSK button.

### Inverting a Route

Inverting a route allows you to swap the route terminal and initial points. Route inverting is only applicable to a non-activated route.

To invert a route:

1. Press the **SELECT** FSK button from the **PLAN** sub-mode.
2. Use the cursor manipulator to select the **INVERT** option and then press the **SELECT** FSK button.
3. The display will then display the inverted route.



3-71: Loaded route before inverting



3-72: Selecting MENU/PLAN/INVERT sub-mode



3-73: Result of inverting route

The inverted route can be subjected to all the operations for route editing and saving in the ABRIS database.

## Deleting a Route

Routes that are deemed of no further use can be deleted from the database. To do so:

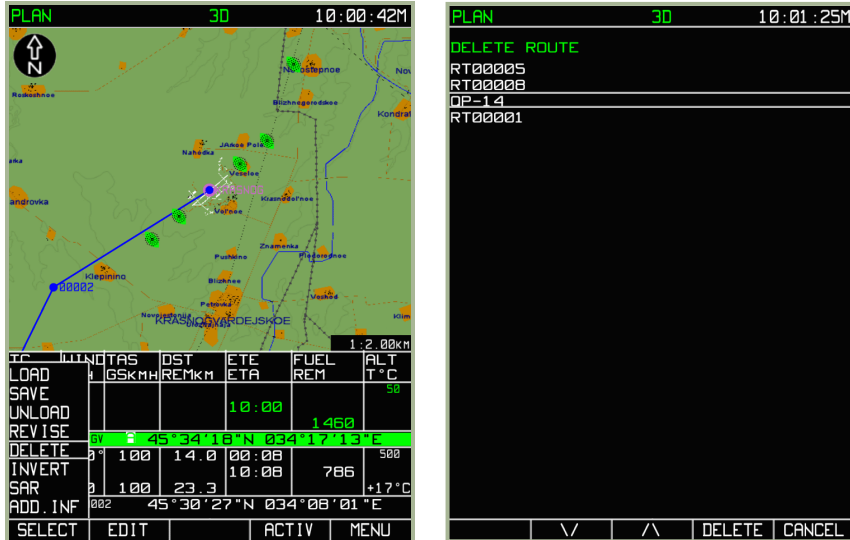

### 3-74: Selecting MENU/PLAN/DELETE function

### 3-75: Selecting route for deleting

1. Press the **SELECT** FSK button from the **PLAN** sub-mode.
2. Use the cursor manipulator to select the **DELETE** option and then press the **SELECT** FSK button.
3. From the **DELETE** sub-mode page, use the  $\nabla$ ,  $\Delta$  FSK buttons or the cursor manipulator control to select the route to be deleted with the active marker and press the **DELETE** FSK button. Should it become unnecessary to delete the route, press the **CANCEL** FSK button instead of **DELETE**.
4. To exit the **DELETE** sub-mode page, press the **CANCEL** FSK button.

## Adding and editing map points (DIRECTLY mode)

To help denote important point locations on the moving map like targets, landmarks, airfields, etc., you may add map points with labels to the map. This can be a useful tool for marking friendly positions, enemy positions, and battle positions (BP) prior to taking off.

To add and edit map points, press the **SELECT** FSK button from the **PLAN** sub-mode and then select the **ADD INF** (add information) option from the pop-up menu.

Move the black box marker to the location you wish to place a map point and then press the **ADD PNT** FSK button. From the pop-up menu, select **DIRECTLY** and press the **ADD PNT** FSK again or press the cursor manipulator control. If the cursor is over an existing

map point, an **EDIT** FSK button will be displayed instead. By pressing the **EDIT** FSK button, you can modify the data entered for an existing map point.

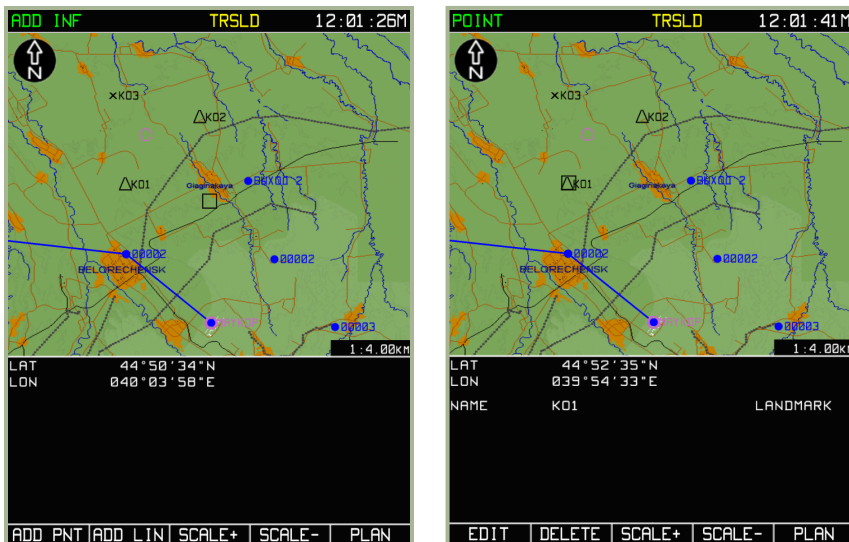

**3-76: Marker positioned to create a new map point**

**3-77: Marker positioned to edit an existing map point**

To change type of map point, press the **TYPE** FSK button to cycle through your choices – AIRPORT, NDB, LANDMARK, OBSTACLE, REFPOINT, or VOR.

PARAMETER	POINT TYPE					
	VOR	ARP	NDB	LANDMARK	OBSTACLE	INT
Name	+	+	+	+	+	
Latitude	+	+	+	+	+	+
Longitude	+	+	+	+	+	+
Callsign	+		+			+
Band	+		+			
Altitude	+	+	+		+	
Display symbol	V	A	N			I

Note: Plus (+) sign is used for marking parameters characterizing concrete point types.

Below the map are three fields that you can edit. Use the ►► FSK button to cycle between the three fields – NAME, Coordinate, and ALTITUDE. Use the cursor manipulator to edit the active line.

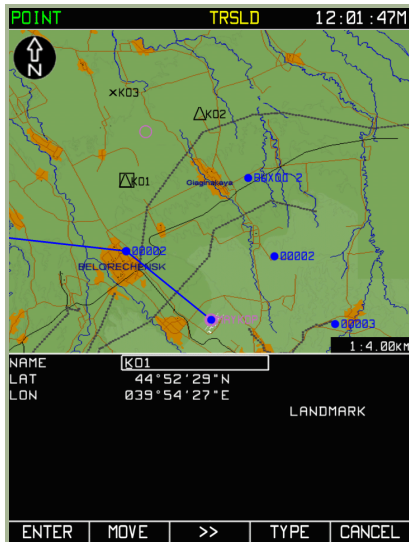

3-78: Entering name of map point

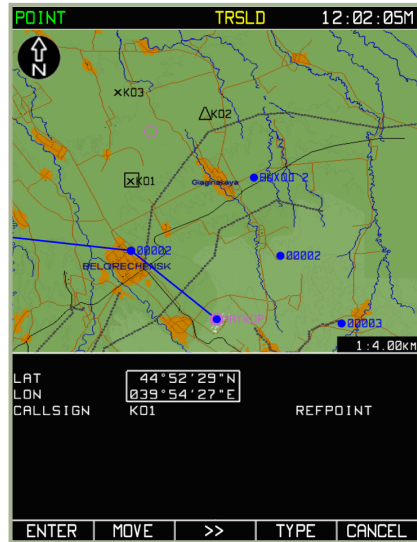

3-79: Entering coordinate of map point

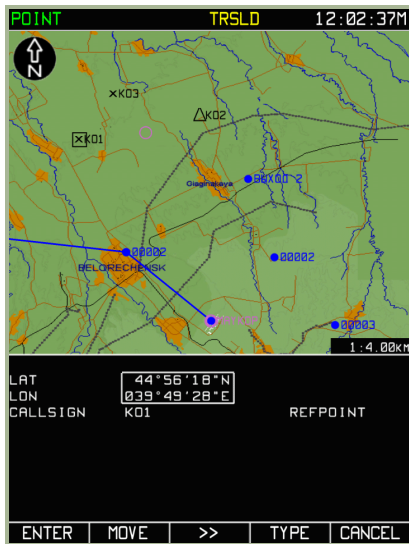

3-80: Moving a map point

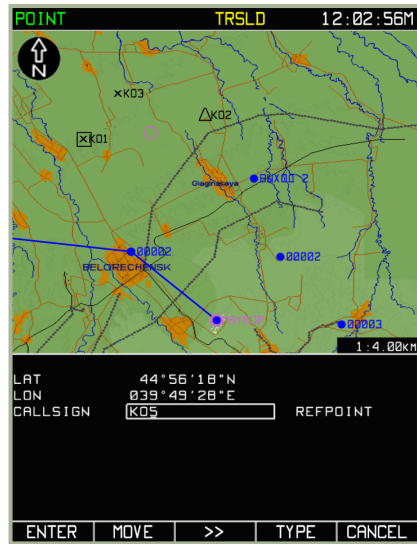

3-81: Editing callsign

In map point **EDIT** mode, a **MOVE** FSK button is available. To move a map point, press the **MOVE** FSK button and move the map point with the cursor manipulator.

To delete a map point, place the cursor over the map point you wish to remove and press the **DELETE** FSK button.

Once you have finished creating a new map point, or editing an existing one, press the **ENTER** FSK button.

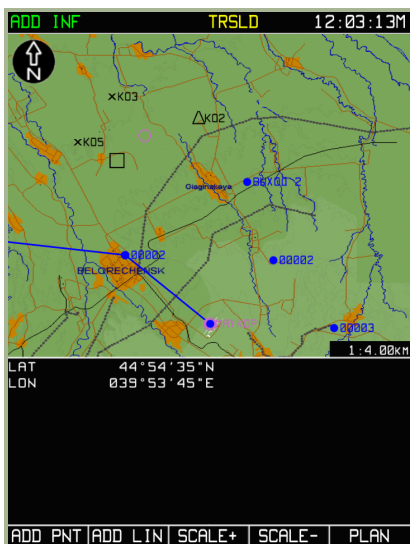

**3-82: ADD INF sub-mode page after pressing ENTER FSK button**

### Adding and editing map points (RELATIVE mode)

To save map points into the ABRIS database, please review the earlier section of this manual regarding the MENU/CTRL/SETUP/DTB functions. You can add map points using known bearing and range (RELATIVE mode).

This mode is used to create a navigation point from the database that's bearing and ranges are known.

From the **ADD INF** sub-mode option, press the **ADD PNT** FSK button. Use the cursor manipulator to highlight the **RELATIVE** option line and then press the **ADD PNT** FSK button. The flight information area will be displayed and divided into top and bottom parts. The top part contains information on the new navigation, whereas the bottom part shows information on a point available in the database.



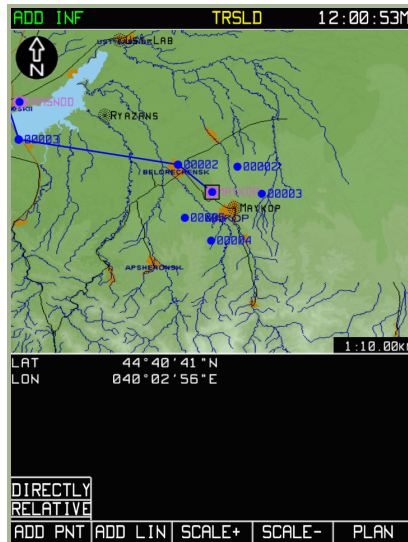

### 3-83: Plot point by known azimuth and range (RELATIVE) mode

Use the **TYPE** FSK button to select the point type. Then use the ►► FSK button to cycle between the active lines for the new navigation point properties and use the cursor manipulator control to adjust the values.

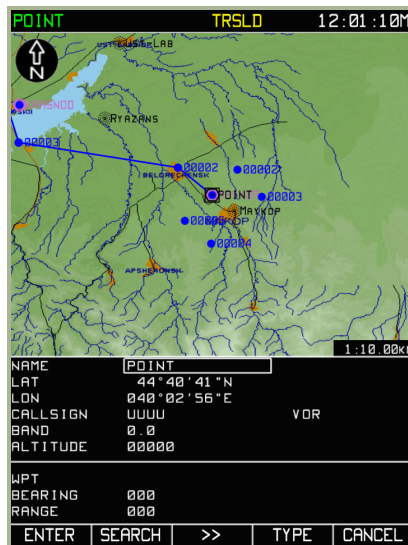

### 3-84: Selecting navigation point with TYPE button

Use the ►► FSK button to switch to the WPT line in the bottom section of the information window and enter a name of the WPT that you will be setting BEARING and

RANGE from to calculate the point coordinates. Use the ►► FSK button and the cursor manipulator to enter values from the selected point in the BEARING and RANGE data boxes. When entering the bearing and range values, pay attention to the measurement units (i.e., if the BEARING is true or magnetic, if the RANGE uses kilometers or miles).

Information for a new navigational point which is being added to the database

Information on a point available in the database

POINT	TRSLD	12:02:20M
NAME	UUUU	
LAT	44°52'42"N	
LOX	039°55'46"E	
LANDMARK		
WPT		
BEARING	000	
RANGE	000	
ENTER	SEARCH	>>
	TYPE	CANCEL

### 3-85: Active lines for filling

POINT	TRSLD	12:02:44M
NAME	35	
LAT	44°52'42"N	
LOX	039°55'46"E	
LANDMARK		
WPT		
BEARING	000	
RANGE	000	
ENTER	SEARCH	>>
	TYPE	CANCEL

POINT	TRSLD	12:03:09M
NAME	35	
LAT	44°52'42"N	
LOX	039°55'46"E	
LANDMARK		
WPT	00002	
BEARING	000	
RANGE	000	
ENTER	SEARCH	>>
	TYPE	CANCEL

### 3-86: Entering callsign of a new (added) navigation point

### 3-87: Input callsign of a navigation point available in the database

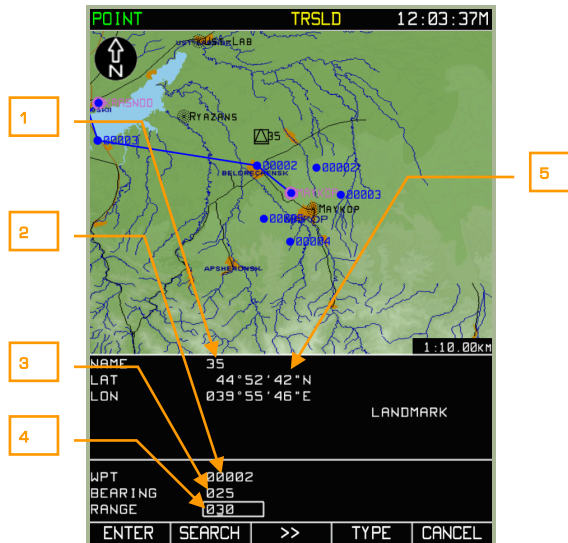

**3-88: Entering values of BEARING and RANGE from the navigation point available in the database**

1. Name of new point
2. Callsign of database reference point for plotting of new point with entering bearing and range
3. Bearing from reference point
4. Range from reference point
5. Coordinates of cursor

Press the **SEARCH** FSK button. If the wrong WPT was found, continue pressing the SEARCH button until the desired WPT is found.

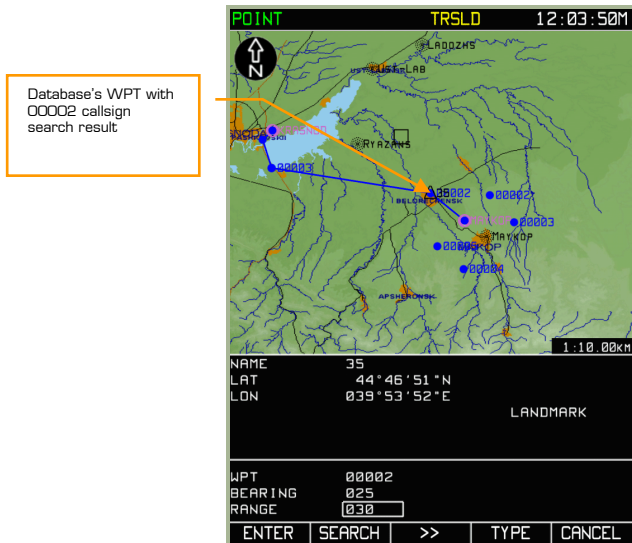

### 3-89: Result of searching the database point for plotting of new point with entered bearing and range

A current marker of the point will be placed over the searched database point.

Press the **ENTER** FSK button and a marker of the point with its callsign will appear on the map at the calculated location corresponding to bearing and range.

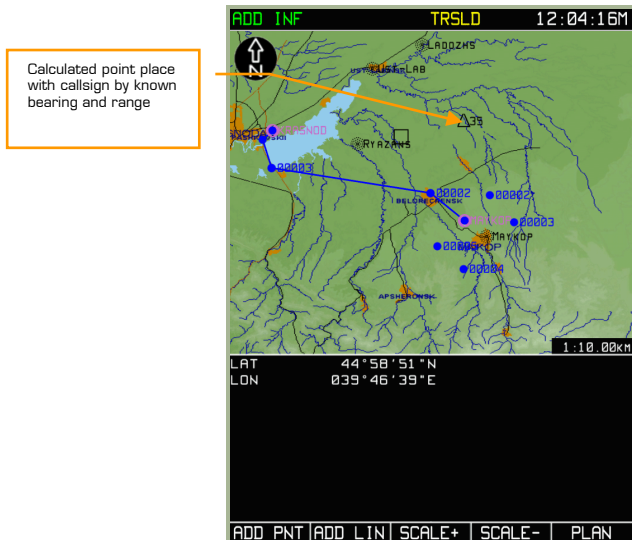

### 3-90: Display of calculated point by known bearing and range

## Adding and editing map lines

Lines can be plotted on the map to denote phase lines, free-fire areas, FEBA, etc.

To create a map line, or geometric figure formed by straight line segments, use the following procedure:

1. Press the **SELECT** FSK button from the **PLAN** sub-mode page and select the **ADD INF** option from the menu. Press the **SELECT** FSK button again.
2. Use the cursor manipulator to move the black square cursor to the map location where you want the line to start and press the **ADD LIN** FSK button.
3. The screen will now display the **LINE** page and the flight information area will display the line start coordinates, parameters characterizing the line to be plotted, and the line color list. By pressing the **COLOR** FSK button, you can select the line color.
4. Using the cursor manipulator control, move the cursor to where you want the line to end and press the **ENTER** FSK button. A line will now be drawn between the two ends. You can repeat this process to create multi-jointed lines or polygons.
5. If you wish to exit the mode without entering data into the database, press the **CANCEL** FSK button without pressing the **ENTER** button.

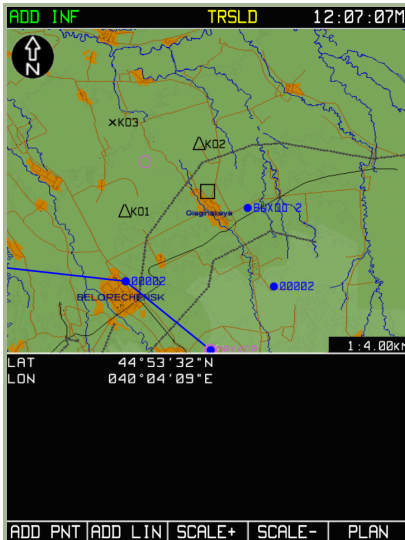

3-91: Selecting ADD LINE function

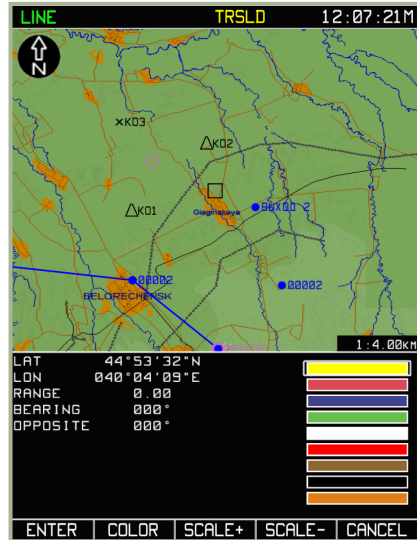

3-92: View of LINE page

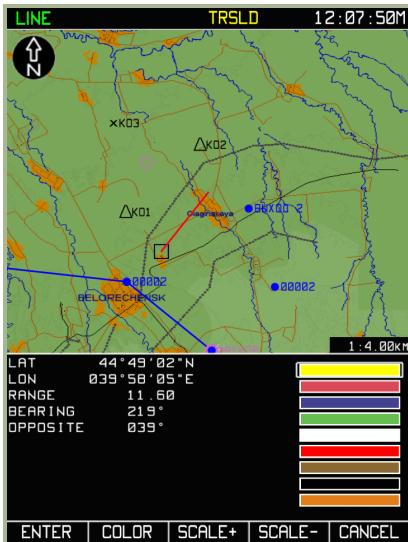
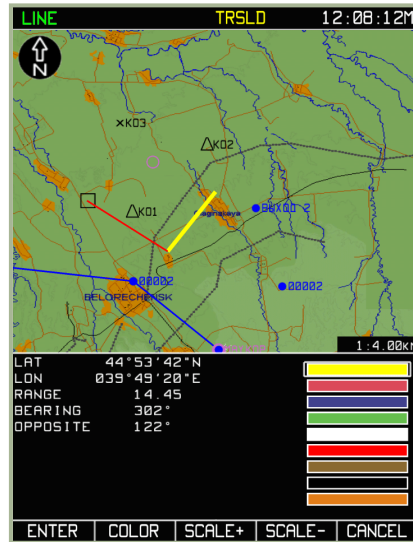
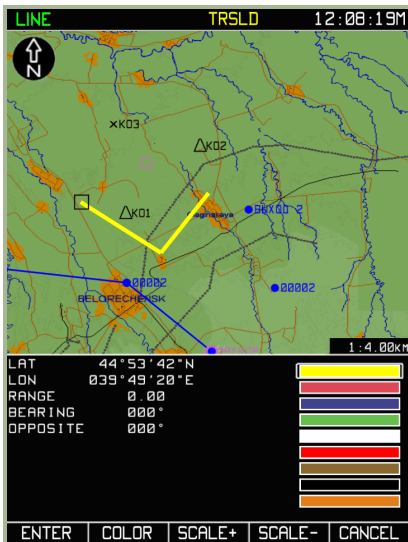
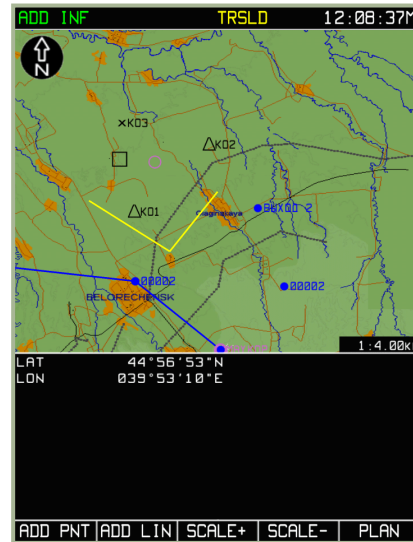
**3-93: Plotting first line segment**

**3-94: Plotting second line segment**

**3-95: Press ENTER button after second line segment plotted**

**3-96: End of line plot, after CANCEL button**

When it is necessary to plot several lines that are not connected with each other, perform the procedure for plotting one line; press the **CANCEL** FSK button, and repeat the procedure for the second line, press **CANCEL** button, etc.



To save map lines into the ABRIS database, please review the earlier section of this manual regarding the MENU/CTRL/SETUP/DTB functions.

## MENU/GNSS Sub-mode

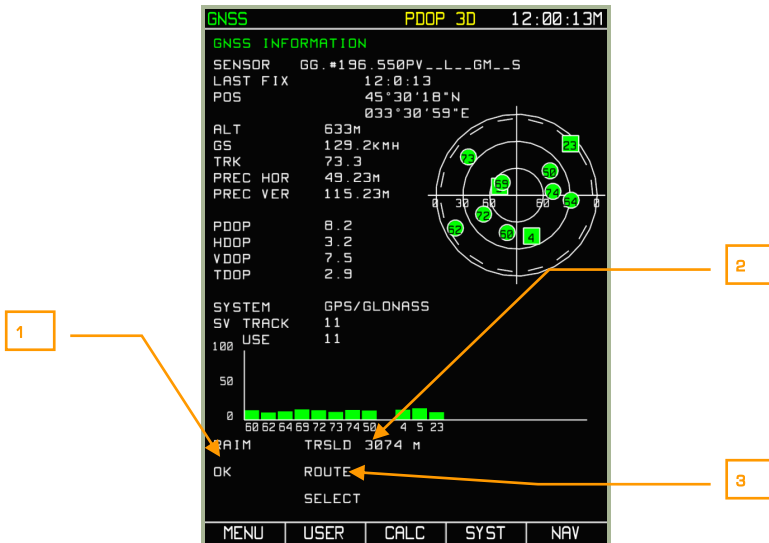

The Global Navigation Satellite System (**GNSS**) sub-mode of the **MENU** operating mode is intended to assess the status of the satellite navigational system (number of tracked and processed satellites, geometric factor, signal/noise ratio for each of the processed satellites, etc.). In this sub-mode, the following is shown on the display:

- Current time
- Type and serial number of the NAVSTAR/GLONASS sensor
- Time value received from the satellite constellation
- Geographic coordinates
- Ellipsoid height
- Ground speed
- Actual track angle
- Predicted absolute accuracy of aircraft position along the horizontal and vertical components
- Probability characteristics of aircraft position accuracy
- Information on the satellite constellation and the current satellite usage mode
- Position of satellites shown graphically and a graphic presentation of the signal/noise ratio from the satellites in use
- Receiver Autonomous Integrity Monitoring (RAIM) status that includes a qualitative assessment of the positioning accuracy and the results of assessing the satellite constellation status by the built-in GNSS sensor monitoring system. This is the the threshold value used for calculating the probability assessment of the positioning accuracy. The RAIM assessment is in regards to the current flight phase.



### 3-97: MENU/GNSS sub-mode display

1. Qualitative assessment of the positioning accuracy and the result of an assessment of the satellite constellation status by the built-in GNSS sensor monitoring system.
2. The RAIM threshold value used to evaluate position accuracy. If the actual RAIM value exceeds the threshold value, the position data is not deemed reliable/accurate and a different satellite may be used.
3. The current flight phase that the RAIM assessment is in regards to.

Within the satellite constellation, GLONASS satellites are displayed with a square symbol , and NAVSTAR are displayed with a round symbol - . Satellites used for calculations are green colored and those that have been excluded from calculations are colored gray. The number in the symbol corresponds to the satellite number within the constellation.

You can manually set the required RAIM threshold value in the **MENU**→**OPTIONS** page on RAIM THRSLD line. To change the value, rotate the cursor manipulator to select the RAIM THRSLD line item and then press the **CHANGE FSK** button. Then use the > and < FSK buttons to select the character to change and rotate the cursor manipulator to change the character value. Press the **ENTER FSK** button when done. This new value will only be used when the RAIM threshold mode is set to USER.

To change the RAIM threshold mode, select the SELECT THRSHLD line item and then press the **CHANGE FSK** button to toggle between **USER** and **AUTO**. This can also be done by toggling the **AUTO/USER** FSK button on the **GNSS** page.

When the RAIM threshold mode is set to **AUTO**, the following RAIM threshold values are used:

- In the airfield area (landing approach, takeoff) - 370 m (0.3 NM)



- ROUTE – 3,704 m (2 NM)



**3-98: Determining RAIM threshold set by the user**

ATTENTION! Changing the factory RS-232C setting parameters may result in a protocol disagreement between the GNSS and ABRIS. The list of factory settings is listed below:

**Factory RS-232C port settings for interaction with the built-in GNSS sensor**

Parameter	Value
SENSOR	ASHTECH GG12
PORT	BUILT IN
SPEED	19,200
DATA BIT	8
PARITY	NONE
STOP BIT	1
MONITORING	WITH HW FACILITIES
SYSTEM	GPS/GLONASS
PDOP MASK	4.0
RETURN MASK	5 <sup>0</sup>
EXCL SV	0

If one of the satellites is providing inaccurate data (perhaps due to terrain masking between aircraft and satellite), you can use the following procedure to exclude (or include) satellites from (or into) the group for use:

- Press the **SYST** FSK button from the **GNSS** sub-mode page and the system status page will be displayed.

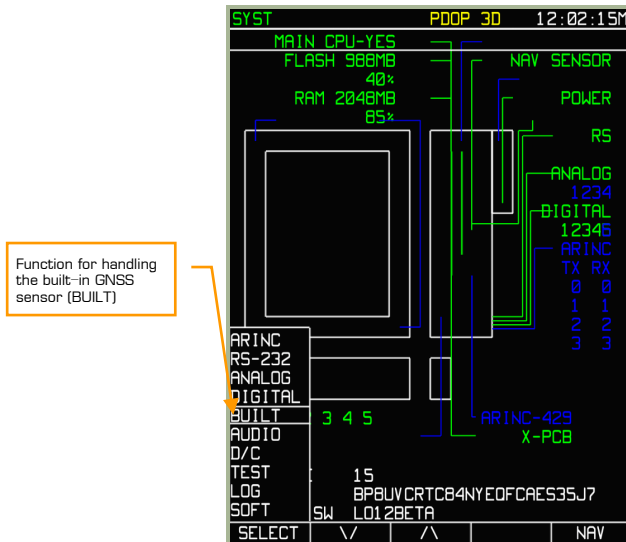

### 3-99: Selection of function for handling the unit SETUP

- Select the **SETUP** pop-up menu by pressing the **SETUP** FSK button.
- Use the up and down arrow FSK buttons or rotate the cursor manipulator control to select the built-in GNSS sensor (**BUILT**) sub-mode option. After selected, press the **SELECT** FSK button.
- The screen will now display the SYST with parameter settings for the built-in GNSS sensor – BUILT-IN SENSOR SETUP.
- Use the up and down arrow FSK buttons or rotate the cursor manipulator control to select the EXCLUDE SV line with the highlight box. This line displays the number of the satellite excluded from constellation use. If the value is 0, all the currently visible satellites are used.
- Press the **CHANGE** FSK button and enter the number of the satellite to exclude from calculations. To do so, press the cursor manipulator control to cycle between characters in the field and rotate the control to adjust the value of each character. This number should correspond to one of the satellites visible in the constellation. To exclude the satellite from use in calculations press the **ENTER** FSK button.



**3-100: View of the display during the procedure for excluding a satellite from calculations**

- Satellites will not be excluded from calculations until you save the values; to do so, select the SAVE AND TEST line by using the cursor manipulator or up and down arrow FSK buttons. The name of the **ENTER** FSK button will change to **TEST**. Press the **TEST** FSK button and in the bottom part of the display, commands for the exchange between the ABRIS and GNSS sensor will be seen. The EXCL indication of a satellite being excluded from calculations appears in the principal operating modes.
- After the test has run for a little while and the change saved, press the **STOP** FSK button.



**3-101: SYST page during testing of the GNSS sensor and its communication channel**

**3-102: GNSS page after excluding satellite 73 from calculations**

Satellites located below the elevation mask are colored grey, and the elevation mask is indicated on the display as a gray-dashed circle. Satellites located outside this circle are deemed to be masked by terrain elevation.

Use the following procedure to adjust the elevation mask:

- Select the **SETUP** pop-up menu by pressing the **SETUP** FSK button.
- Use the up and down arrow FSK buttons or rotate the cursor manipulator control to select the built-in GNSS sensor (**BUILT**) option. After selected, press the **SELECT** FSK button.
- The screen will now display the SYST with parameter settings for the built-in GNSS sensor – BUILT-IN SENSOR SETUP.
- Use the up and down arrow FSK buttons or rotate the cursor manipulator control to select the **ELEV MASK** line with the highlight box.
- Press the **CHANGE** FSK button and use the cursor manipulator and the  $\nabla$ ,  $\Delta$  FSK buttons to set the elevation mask angle. For example, in very mountainous terrain, you may wish to use a narrow angle. Note though that your positioning may revert to 2D from 3D when angle is so wide that too many satellites are being blocked by terrain masking.

The mask value will not be used in calculations until you **SAVE & TEST** the item – **SAVE AND TEST**



Changing the elevation mask to 45 degrees

**3-103: GNS page after changing elevation mask angle**

### MENU/GNSS/CALC Sub-mode

Calculations (**CALC**) sub-mode is intended to make predictive calculations of RAIM status in regards to navigational route points available through the ABRIS database. The **CALC** sub-mode will compare route points to the satellite constellation expected to be over those points.

Predictive calculation of RAIM status for navigational points through the ABRIS database and viewing of the satellite group almanac is available:

- For current aircraft position (viewing of satellite group almanac only).
- For the airfield destination with prediction of RAIM status taken into account.
- For any airfield available in the ABRIS database.

To view the **CALC** sub-mode page, press the **CALC** FSK button on **MENU/GNSS** sub-page. In **CALC** mode, the display presents information fields similar to that of the **GNS** sub-page with some exceptions:

- **DESTINATION AIRDROME** – navigational point that the RAIM prediction calculations will be derived for.
- **Estimated Time of Arrival (ETA)** – This field allows you to input the time that the calculations for RAIM prediction should be made for, UTC – stands for Greenwich Time.
- **Position (POS)** – This field displays the geographic coordinates of the aircraft's position that the calculations of RAIM prediction should be made for (filled in automatically after the navigational point has been found in the ABRIS database).

- **PRAIM ETA** – This field displays the time that the calculations RAIM prediction has been made for (filled in after the calculations have been completed), and it provides a qualitative assessment of the RAIM prediction (YES/NO).

The notation +/- 15 MIN refers to the RAIM prediction table located below. In the calculations, the status of the satellite group is assessed at the moment of arrival at the airfield, and from this moment ±15 minutes with steps of 5 minutes. The data is displayed in the form of a table. The table cells are filled in with either a green + (plus symbol, in the case of a favorable prediction), or with a yellow - (minus) symbol if the RAIM prediction is unfavorable.

Satellite orbit data in reference to the current aircraft position is performed in the absence of an active route. To view, press the **CALC** FSK button. The following data will be displayed on the screen:

- Indication of constellation viewing in the SENSOR information field.
- Graphic representation of the predicted satellite arrangement from constellation almanac data.

Viewing of the constellation almanac (what satellites will be over a specified coordinate at a given time) for the airfield of arrival, the predictive RAIM status takes into account the entered flight parameters if the following conditions are fulfilled:

- Availability of an active route.
- Availability, among the parameters, of predicted time of departure and predicted true airspeed on the route legs.



**3-104: Automatic preparation of data for viewing of the almanac and making RAIM prediction calculations for the airfield of destination**

**3-105: Viewing the almanac and RAIM prediction for the airfield of destination**

If all these conditions are fulfilled, pressing the **CALC** FSK button will display a window for viewing the almanac and making calculations with completed fields. To make these calculations, press the **ENTER** FSK button. The completion of the calculation is indicated by the CALCULATIONS DONE message in yellow at the bottom of the page.

To change the calculation performance time, press the **>>** FSK button and specify the time in the box (only the current date is taken into account), and press the **ENTER** FSK.

The display of the almanac (satellite constellation graphic) and calculations of RAIM prediction for any airfield available in the ABRIS database can be performed in the predictive RAIM mode for the current aircraft position or in the case of RAIM prediction for the airfield of arrival.

To make such calculations, press the **>>** FSK button and switch to the callsign input window. Use the cursor manipulator to enter the callsign of the navigation point you wish to make the prediction for. To select the calculation performance time, press the **>>** FSK button, and in the editing box specify the time (only the current date is taken into account).

For example: Data preparation and calculations for Anapa airfield (URKA) is shown below. In this example, the selected predicted time of arrival is 14:15. Calculations are made after a press of the **ENTER** FSK button. If the source data (navigation point callsign) is correct, the screen will display the results of RAIM predicted calculations. If the navigation point is not found in the ABRIS database, an appropriate yellow NOT FOUND message will be displayed.



**3-106: Preparation of data and performance of calculations for Anapa airfield**



### 3-107: Error message that callsign (RRRR) is not a valid ABRIS callsign

In the **CALC** sub-mode, the FSK buttons have the following meanings:

- MENU, GNSS, NAV – Switches to the respective modes; in this case, the almanac use mode is automatically turned off, the GNSS sensor switches to the operating mode.
- ENTER – Executes calculating RAIM prediction for the selected airfield of arrival.
- ►► – Switches between fields for entering the destination airfield and time of arrival.



## Active Route Modes and Functions

While the MENU operating mode is generally devoted to setting up the ABRIS system and assists in sortie planning, the three active flight operating modes (NAV, ARC and HSI) share a common set of functions that are most useful while flying the mission.

You can cycle between the main operating modes by pressing the right most FSK button.

### NAV Operating Mode

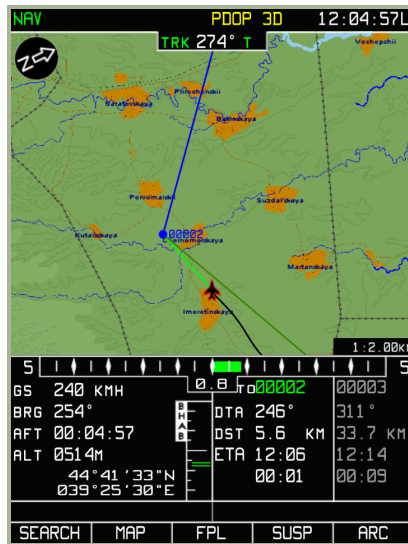

#### 3-108: NAV operating mode

In the **NAV** operating mode, a moving map with the following navigational information is displayed:

- System bar showing the selected mode, GNSS status, and current time (UTC or local)
- North arrow
- Current track/heading (digital and graphical representation)
- Desired track angle
- Ground speed (digital presentation)
- Cross track error - XTE (digital and graphical representation)
- XTE scale
- Bearing to steerpoint
- Flight time

- Aircraft altitude
- Information on the current and next route leg: WPT name, distance to go to the WPT in the current route leg information field, estimated time of arrival at the steerpoint, time to WPT OVER, and for the next route leg – calculated flight time from the current position to the WPT OVER.
- Current geographic aircraft coordinates
- Moving map display scale
- Route selected for navigation (graphic presentation)

## ARC Operating Mode



### 3-109: ARC operating mode

In ARC mode, the screen displays the system bar and the following navigational information:

- Current track/heading (digital and graphical representation)
- Compass card (at least 90° shown)
- Route selected for navigation (graphical representation)
- Aeronautical information
- Desired track angle
- Desired track angle/heading (set by the cursor manipulator knob)
- Ground speed (digital representation)
- Cross track error - XTE (digital and graphical representation)

- XTE scale
- Difference between the current and desired heading values (graphical representation)
- Aircraft altitude
- Information on the current and next route leg: WPT name, distance to go to the steerpoint in the current route leg information field, desired track angle, estimated time of arrival at the given WPT, time to WPT OVER, and for the next route leg – calculated flight time from the current position to the WPT OVER).
- Current geographic aircraft coordinates
- Display scale
- RMI-1 (digital and graphical representation)
- RMI-2 (digital and graphical representation)

No topographical map information is displayed in this mode.

### HSI Operating Mode



#### 3-110: HSI operating mode

In HSI mode, the screen displays the system bar, navigational information, imitation of a standard horizon situation indicator (HSI), and flight route information as follows:

- Current track/heading (digital and graphical representation)
- Desired track angle (digital and graphical representation)
- Desired track angle/heading

- Compass card (360°)
- Vertical navigation scale
- Ground speed (digital representation)
- Cross track error - XTE (digital and graphical representation)
- Difference between the current and desired heading values (graphical representation)
- Aircraft altitude
- Information on the current and next route leg: WPT name, distance to go to the steerpoint in the current route leg information field, desired track angle, estimated time of arrival at the given WPT, time to WPT OVER, and for the next route leg – calculated flight time from the current position to the WPT OVER).
- Current geographic aircraft coordinates
- RMI-1 (digital and graphical representation)
- RMI-2 (digital and graphical representation)

## Common Function Select Keys (FSK) buttons

At the bottom of each of these three modes, a common set of FSK buttons are displayed. The exception is the right-most button that indicates the operating mode that will be directed to if the FSK is pressed.

The other four common FSK buttons are:

1. **SEARCH** – to switch to **SEARCH** mode
2. **MAP** – to switch to **MAP** mode
3. **FPL** – to switch to Flight Plan (**FPL**) mode
4. **SUSP** – to switch **WPT** (current steerpoint) manually

What follows are detailed descriptions of the sub-modes associated with these four FSKs.

## SEARCH Sub-mode

This mode is intended for use in emergencies. The mode allows you to locate a specified AIRPORT, VOR, NDB, WPT, or TOWN (geographic point or navigational points). When using this mode, searches are all done using callsign names.

To access this **SEARCH** sub-mode, press the **SEARCH** FSK button, and then select AIRPORT, VOR, NBD, WPT, or TOWN from the pop-up menu by rotating the cursor manipulator. Once you have selected the option from the pop-up menu, press the **SEARCH** FSK button to search for the closest examples of the object type being search for. For example: if you select AIRPORT as the object type, the search will display the closest airfields to your current location.

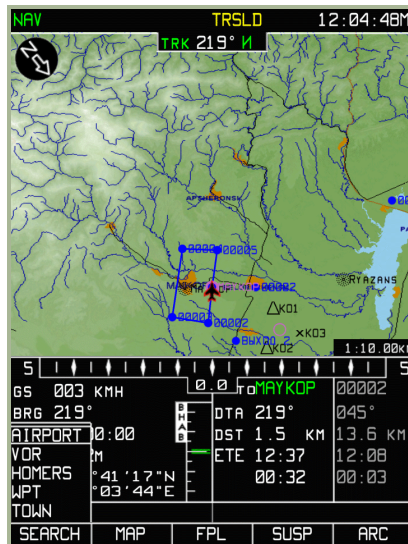

### 3-111: Selecting object type for search

After the search is complete, you may rotate the cursor manipulator to scroll through the search results. The nearest objects of the search type will be listed from top to bottom. The selected entry will have its entry number colored blue.

SEARCH
TRSLD
12:05:05M

1:10.00km

NEAREST AIRPORTS		
1	MAYKOP 180M URKM MIL RUNWAY 1200M	219°N 1.5
2	KRASNODAR-PAVKO 2M TULU AIRPORT RUNWAY 0M	338°N 29.4
3	KRASNODAR-PASHKOVSKY 34M URKK MIL RUNWAY 731M	294°N 61.0

SEARCH
TO
INFO
NAME
NAV

### 3-112: Search for closest AIRPORTS

If you wish to search for an object by its name, press the **NAME** FSK button on the search result page and enter the object name by using the cursor manipulator. When entering the letters of an object's name, the automatic search function will try to match the entry to an item in the database.

SEARCH
TRSLD
12:07:14M

1:10.00km

URK

1	ANAPA URKA MIL 44°59'56"N 44°59'56"E	275°N 216.8
2	KRASNODAR-PASHKOVSKY URKK MIL 45°02'05"N 45°02'05"E	294°N 61.0
3	MAYKOP URKM MIL 44°40'41"N 44°40'41"E	219°N 1.5

SEARCH
TO
INFO
NAME
NAV

### 3-113: Entering an object name for a NAME search

When the search is complete, the page will display a table with objects (locations) sorted according to the following criteria:

- At the top of the list will be navigational points whose names are in strict correspondence with the request, i.e., if a search was made with the name "URK" in the AIRPORT object type category, then at the beginning of the list will be AIRPORT's with URKA in the name.
- These will be followed by AIRPORT category objects whose names start with URK (URKK, URKM).

With an entry in the search results table selected (indicated by the entry number being highlighted in blue), press the **INFO** FSK button to display the **INFO** page that will provide the following information on the selected table entry:

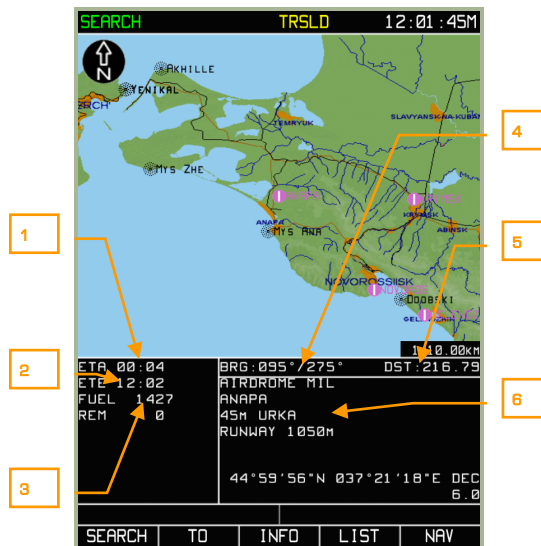

### 3-114: Information on searched point

1. Steerpoint ETA (based on current ground speed).
2. Estimated time enroute (ETE) to the point (based on current ground speed).
3. Current fuel level and estimated remaining fuel after reaching point from current coordinates.
4. Bearing to/from current aircraft position to the selected point.
5. Distance between current aircraft position to the selected point.
6. Depending on the type of point, various kinds of information may be displayed here: object type, name, elevation, frequency, callsign, runway length, and coordinates.

To create a direct route between your current location and the selected point, press the **TO** FSK button. If you do this, the active route will be unloaded and only one flight leg will be activated – from your current position to the selected point.

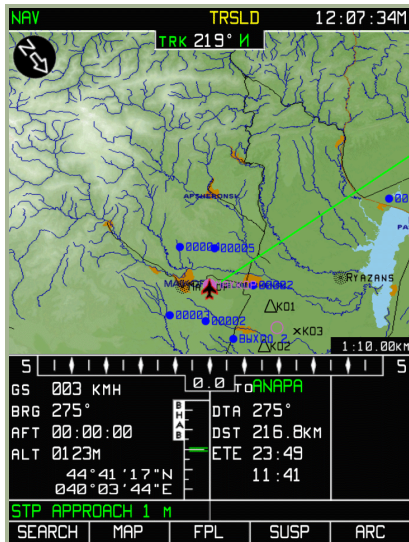

**3-115: Active navigational calculations to the selected point**

To return to the **NAV** mode, press the **ARC** FSK button.

## MAP Sub-mode



**3-116: MAP sub-mode**

In the **MAP** sub-mode, the following functions can be performed:



- **INFO** function – To obtain information on an object displayed on the map beneath cursor.
- **ERBL** function – To measure distances and bearing between objects plotted on the map, arbitrary points, between the current aircraft position and a map object, or an arbitrary point.
- **TO** function – To create a route between your current position and a selected object (arbitrary point on the map). This is accessed through the **INFO** sub-mode. Attention! With the selection of this mode, the active route will be unloaded.

The Map sub-mode also provides you the ability to change the scale of the moving map: **SCALE+** and **SCALE-**.

The FSK buttons at the bottom of the Map sub-mode page have the following meanings:

1. **INFO** – To obtain information about an object
2. **ERBL** – To measure bearing and distance from present position to an object
3. **SCALE+** – To increase map scale
4. **SCALE-** –To decrease map scale
5. **NAV** – To switch to NAV mode

## MAP/INFO Sub-mode

The **INFO** sub-mode provides information about map objects from the databases within the ABRIS digital cartographic and aeronautical information system; as this function is performed, **ERBL**, **TO**, and **SCALE±** functions are available.

To activate the sub-mode, press the **INFO** FSK button.

The following is shown on the **INFO** page:

- North-up, stabilized map
- Flight information area with an additional line indicating aircraft heading value
- Active cursor marker (red square - )
- Cursor current coordinates in the top right portion of the flight information area (indicated by the MRK abbreviation)

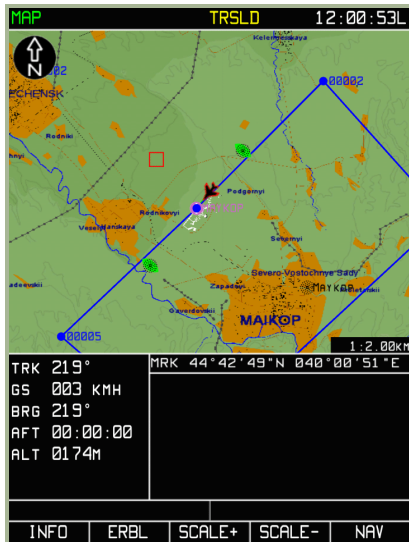

### 3-117: INFO sub-mode

To obtain information about a map object, use the cursor manipulator (□) to move the active marker over the map object you are interested in. Remember that you need to click on the cursor manipulator to toggle horizontal and vertical control.

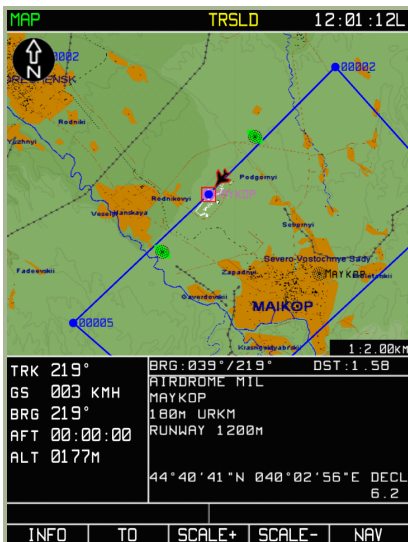

### 3-118: Information for Maikop airfield

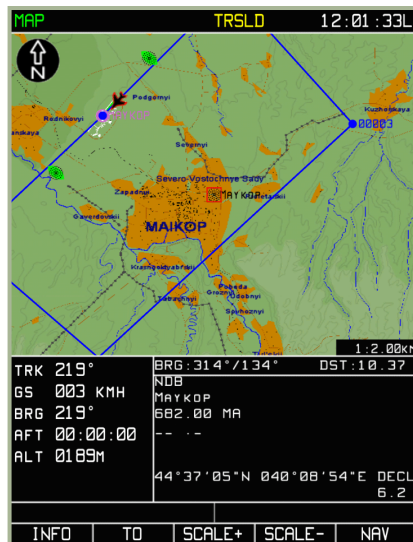

### 3-119: Information for Maikop NDB

Once the cursor is over the object, press the **INFO** FSK button again and information about the object is displayed in the lower right portion of the flight information area. In this case, instead of the marker's coordinates, the flight information area displays the direct and reciprocal bearing and distance from the aircraft position to the object. If no object is displayed within the active marker box, the information field is not updated, i.e., it retains the same information as displayed before pressing the **INFO** button.

If the **INFO** FSK button is pressed, the **ERBL** FSK button changes to be a **TO** FSK button. If the **TO** FSK button is then pressed, a direct route between the aircraft position and the object point will be created and unload any current route.

The **ERBL** mode is returned to with any motion of the marker.

To exit the MAP/INFO page, press the **NAV** FSK button or press the **TO** FSK.

## MAP/ERBL Sub-mode

The Estimated Range and Bearing Line (**ERBL**) function enables measurement of distance and bearing between two points. The starting point of an **ERBL** measurement can coincide with the aircraft's position or an arbitrary point on the map. The terminal end of the measurement can be any object or an arbitrary point on the map. When this function is performed, the **INFO**, **TO**, and **SCALE±** functions are available.

To activate the **ERBL** function, press the **ERBL** FSK button.

The following is shown on the MAP/ERBL page:

- North-up stabilized map
- Flight information area with an additional information line: aircraft actual track angle value
- Active cursor marker - red cross 
- Current marker coordinates are displayed in the top right portion of the flight information area (ERB – marker latitude and longitude; BRG – direct and reverse azimuths to the measured leg beginning point, set initially to the aircraft position; DST – distance from the leg beginning to the current marker position)
- In this mode, the screen does not display the route information field, current heading (above the map), or the true airspeed
- The FSK button changes from ERBL to MARKER

To take an ERBL measurement, position the marker  on the object or map point that will act as the anchor in the to/from measurement. To move the marker, rotate the cursor manipulator control and press it to change between horizontal and vertical control. The measured leg is shown as a red line from the beginning of the measured leg (aircraft position) to the current marker position. As the marker moves beyond the boundaries of the displayed map area, the map is re-drawn automatically, and marker direction of motion is taken into account.

To measure a distance from a selected object, or map point, to another object or map point:

- Move the cursor to the object or map point that you wish to measure from and press the **MARKER** FSK button. This will create a red triangle at that location.
- Move the cursor to the object or map point that you wish to measure to. You will see the red measurement line between the two object/map points.
- ERB, BRG, DST fields move one line down and contain data on the corresponding parameters measured relative to the set marker.

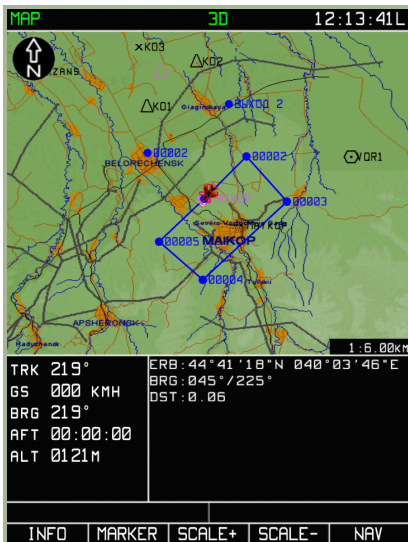

3-120: ERBL function activated

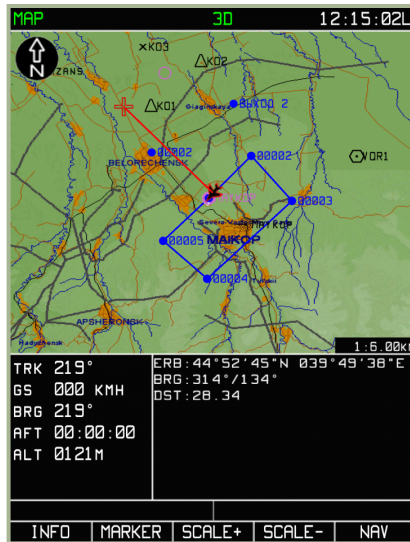

3-121: Marker moved from aircraft initial point

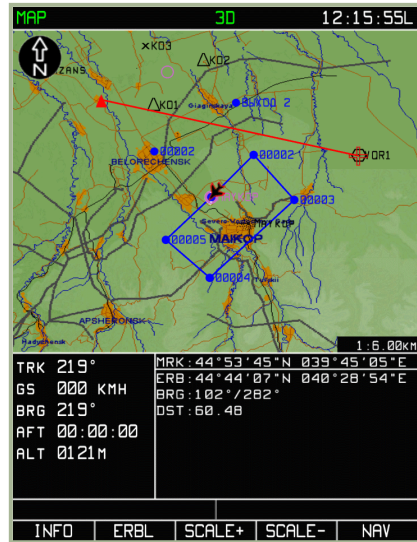
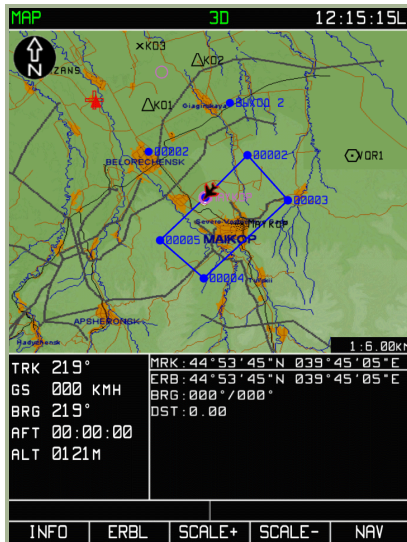

**3-122: MARKER FSK button pressed and new initial measurement point created**

**3-123: Measurements between objects (arbitrary points)**

The **SCALE+** and **SCALE-** functions enable you to change the map scale during this function.

To exit the **ERBL** function, press the **NAV** FSK button.

## FPL Sub-mode

The Flight Plan (**FPL**) sub-mode displays flight information in a tabular form, provided there is an active route loaded. In addition to viewing a route, this sub-mode enables re-targeting of the aircraft to a specified waypoint. The **FPL** page displays the following information:

- Waypoint name
- Waypoint coordinate
- DTK/DMTK/MC of the route leg
- Route leg length
- WPT OVER altitude
- WPT ETO
- Estimate flight time of each leg
- Comments for each leg

In the **FPL** sub-mode, the FSK buttons have the following functions:

1. **VNAV** – Switch to VNAV (vertical navigation) sub-mode to calculate climb and descent points to reach assigned flight altitudes.
2. **TO** – Select a waypoint manually from those available in the **FPL** table and create a new direct route plan. This will unload the current route and replace it with this direct route consisting of only one leg.
3. **WPT**– Select a waypoint manually from those available in the **FPL** and set it as the steerpoint. Flying to the steerpoint will display an XTE relative to the route leg to the WPT preceding the selected waypoint.
4. **NAV** – Switch to **NAV** mode.

1	FPL						PDOP 30		09:35:01L		16		
2	URKA-URKK										17		
3	TC	WIND	TAS	DST	ETA	FUEL	ALT	TH	KMH	GSKMH	REM	T °C	18
4				208.8	09:07	1022						20	19
5	TO 21 URKA 44°59'56"N 037°21'18"E										20		
6	051°	030°	150	20.4	00:06	780	500						21
7	047°	036	184	136.3	09:13	1022	+16°C						22
8	022°	030°	200	51.4	00:13	780	1000						23
9	079°	036	222	84.9	09:27	1022	+16°C						24
10	103°	030°	200	78.2	00:21	780	200						
11	093°	036	214	6.7	09:49	1022	+16°C						
12	203°	030°	060	6.7	00:16	780	24						
13	193°	036	025	0.0	10:05	1022	+16°C						25
14	05 URKK 45°02'05"N 039°09'45"E										26		
15											27		
REM 208.8km ETE 00:00 FUEL 0KG													
VNAV		TO		MOVE		WPT		NAV					

### 3-124: Flight plan sub-mode

1. System bar
2. Route name



3. Desired track angle
4. Heading calculated from entered weather data
5. Active route leg (green color field)
6. Wind direction (entered manually)
7. Wind speed (entered manually)
8. True air speed (planned)
9. Ground speed
10. Distance between waypoints
11. Distance from aircraft position to route terminal point
12. Length of route
13. Time enroute on a route leg calculated from the entered true speed and weather data
14. Waypoint estimated time of arrival (ETA)
15. Departure time
16. Current time
17. Flight altitude (entered manually)
18. Ambient temperature at flight altitude level (entered manually)
19. Fuel flow (entered manually)
20. Estimated fuel remaining at waypoint
21. Fuel quantity (entered manually)
22. Time enroute on a route leg calculated from the entered true air speed and weather data
23. Waypoint ETA calculated from the previously entered time of departure
24. Waypoint ETA calculated in flight from current ground speed
25. Distance from aircraft position to route terminal point, calculated from current ground speed
26. Time to go from aircraft position to route terminal point calculated from current ground speed.
27. Required amount of fuel for flight from aircraft position to route terminal point, calculated from current ground speed





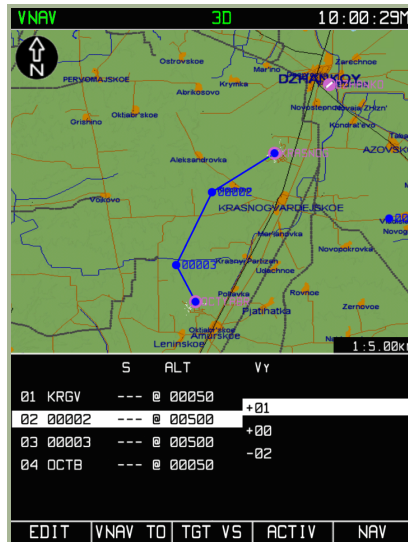

### 3-126: TGT VS function from VNAV sub-mode

- TGT VS:** Pressing the **TGT VS** FSK button plots a profile consisting of the horizontal route and climb/descent at a target vertical speed to/from the selected waypoint. The profile start point is the aircraft's current position and altitude. The end point is at a distance of an S "delta" from the selected waypoint, the delta set in this waypoint, and has an altitude set in this waypoint. The bottom-of-climb (top-of-descent) point is calculated so that moving at a set vertical speed, the aircraft gets exactly to the profile end point. In the intermediate WPT's available in this profile, the altitudes are filled with calculated values; S deltas are set to zero.

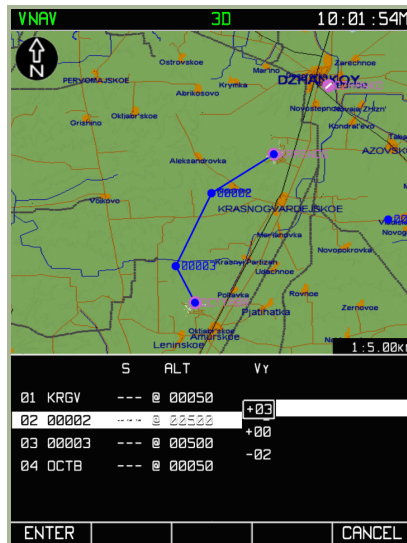

**3-127: Entering of target vertical speed for reaching an altitude**

- **ACTIV**: Makes current plan active
- **NAV**: Exits VNAV mode and switches to the NAV main operating page. A press on the **TGT VS** button opens a vertical speed input box. If you press the **ENTER** FSK in this box, the system will return to **VNAV** mode. The table displays calculated altitudes and vertical speed equal to the set speed. If the vertical speed exceeds the performance limits, it is displayed in yellow.

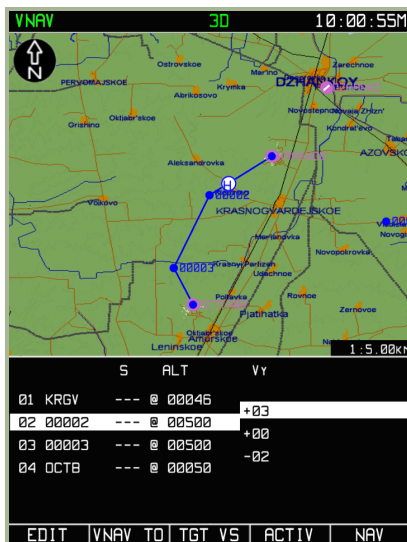

**3-128: Calculated top-of-climb point**



The distance from the start-of-maneuver point (from the current position for **VNAV TO** mode) to the WPT following next, is recorded in the "limit" box of this WPT. This distance is used for initiating an alarm (audio alert) and for the operation of the vertical indicator between this point and the WPT.

The calculated top-of-climb (top-of-descent) points are displayed as part of the flight graphic plan in the form of blue colored dots with "C" for climb, "D" for descent

## SUSP Sub-mode

Pressing the Suspend (**SUSP**) FSK button will cycle through the waypoints in the active route. The Waypoint selected becomes your steerpoint and a green line will connect your current position to it.

## Manually Setting the Steerpoint

During a sortie, it may become necessary to quickly set an arbitrary waypoint in the route as the steerpoint. Two easy ways to do this are:

### WPT or TO function from the FPL mode

1. Select the **FPL** FSK button and the screen will display **FPL** sub-mode page.
2. Rotate the cursor manipulator to select the waypoint that you want to set as the steerpoint and press the **WPT** FSK button.
3. The aircraft course will be re-targeted to the selected waypoint and the cross track error will be displayed as from the route leg connecting the preceding route WPT and the selected WPT.

You could also press the **TO** FSK button from the **FPL** sub-mode page to create a direct, one-leg route to the selected waypoint. This will however unload the current route plan.

### SUSP FSK to cycle steerpoint

1. From the **NAV**, **ARC**, or **HSI** operating pages, press the **SUSP** FSK button.
2. Each press of this button will cycle through the waypoints in the active route; when a waypoint is cycled to, it becomes the steerpoint.



## TACTICAL INFORMATION

Tactical information regarding the helicopters in your flight, mission targets, and threats is available in the **NAV** operating mode. To display or hide this information, TACTICAL SITUATION settings can be configured from the **MAP** options page. The settings are all enabled by default.

Types of tactical information that can be displayed include:

- Up to four helicopters in a flight with corresponding identification numbers
- Three target types
  - Armor and other types of vehicles
  - Air defense systems (AAA and SAM)
  - Other targets including buildings
- Target ingress points (IP)
- Detection zones of known and plotted air defense systems

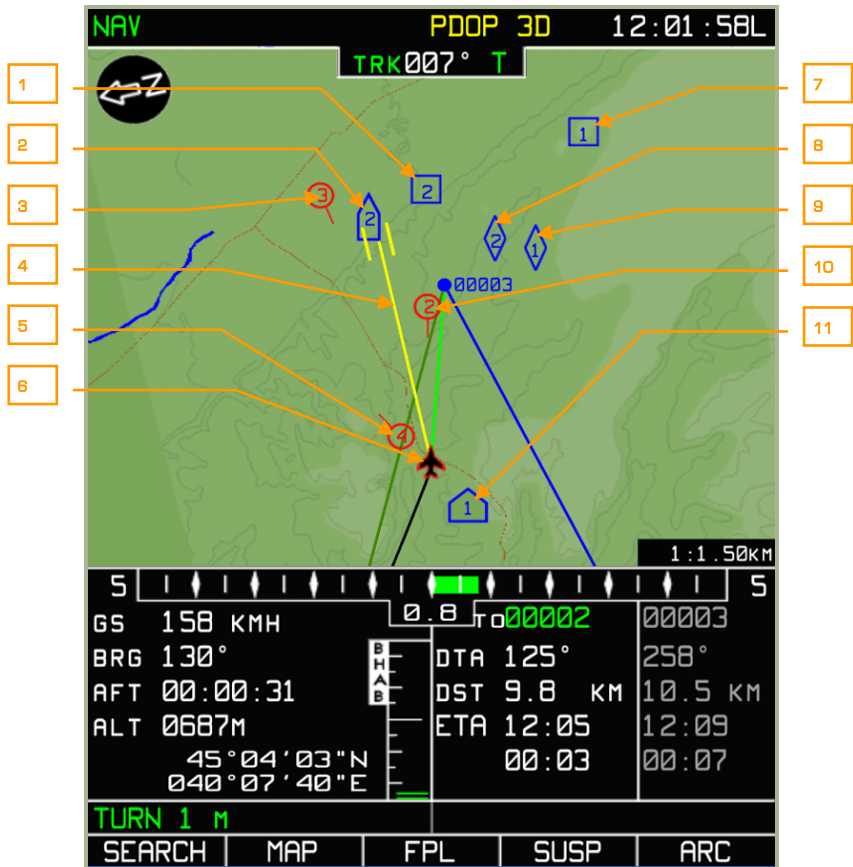

**3-129: Tactical information**

1. "Other" target type. Building, structure #2
2. Target, ADS, or SAM #2
3. Helicopter wingman #3
4. SHKVAL line of sight
5. Helicopter wingman #4
6. Ownship helicopter
7. Target, type "other". Structure #1
8. Target, armor #2
9. Target, armor #1
10. Helicopter wingman #2

### 11. Ingress point #1

Additionally, a yellow SHKVAL line of sight line is displayed. The length of the line corresponds to the range measured by the laser rangefinder.

Targets are marked using three types of blue markers: Air defense systems are marked



armor and vehicles are marked



and other targets including buildings are marked . The target number is assigned using the external targeting system, and this number is displayed within the target marker. The external targeting system can only process up to four targets of the same type. If a fifth target of a type is added, it will overwrite the first one.

**IMPORTANT!** Targets may not have same ID numbers on different helicopters.

The ingress point is marked as . There can be up to four ingress points. Adding a fifth point will overwrite the first one.

For more details on external targeting system procedures and operations, refer to the "External Targeting System" section of this manual.

The SHKVAL line of sight is displayed as a yellow line connecting your helicopter and a line of sight endpoint (two vertical bars). The length of line represents the range calculated by the laser rangefinder. Two vertical bars at the end of the line indicate the ground area that the SHKVAL camera is focused on.

Known air defenses are marked as shaded areas where the circle represents the system's detection range. Know enemy air defenses are those set up in the mission editor as non-hidden. Enemy air defense zones are marked with a blue transparency, and friendly air defense zones are marked with a red transparency.

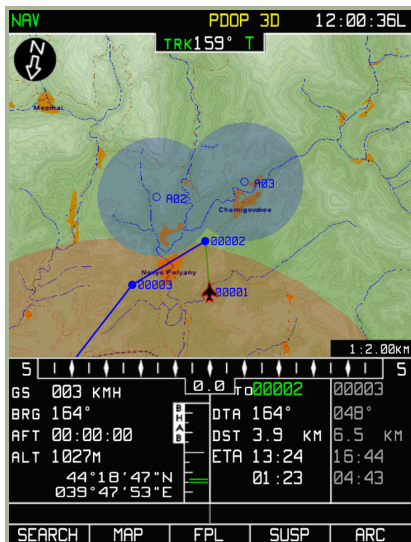

**3-130: Tactical information, air defense detection zones.**

A red circle with a flight direction line extending from it is used to indicate a helicopter within your data link flight (four aircraft maximum). The wingman helicopter ID number is displayed inside the circle. This number corresponds to the setting using the “КТО Я” (WHO I AM) knob on external targeting panel. The flight leader is marked using two concentric circles.

Terrain masking of air defense system sensors is taken into account in accordance with your helicopter’s altitude. This is determined by superimposing the detection zone plane on a cross section of the terrain based on your helicopter’s altitude. Sections that intersect with terrain are removed. This can be a very useful tool for terrain masking tactics.

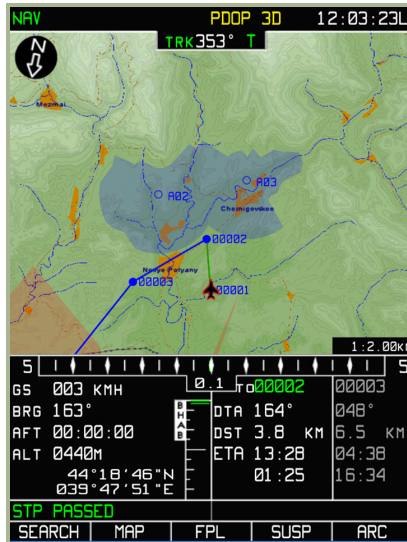

**3-131: Tactical information, air defense detection ranges in a given terrain and in accordance with current helicopter altitude**

Only detection zones for stationary air defenses are displayed. Also, because this information is not updated in real-time, these zones will still be visible after the air defense unit is destroyed.







4

# INFORMATION DISPLAY SYSTEMS

## 4 INFORMATION DISPLAY SYSTEMS

The Information Display System (IDS) is intended for the display of targeting and navigation indications on the heads-up display (HUD), the IT-23 television screen, and the Helmet Mounted Sight (HMS) system.

### Heads Up Display (HUD) Panel

HUD modes include fully operational modes (day and night sub-modes) and the reticle "Setka" sight. The reticle sight can be turned on manually with the **"НОЧЬ-ДЕНЬ-СЕТКА"** (Night-Day-Reticle) selector switch on the HUD panel when in the **"СЕТКА"** (Reticle) position. [8 + RSHIFT]

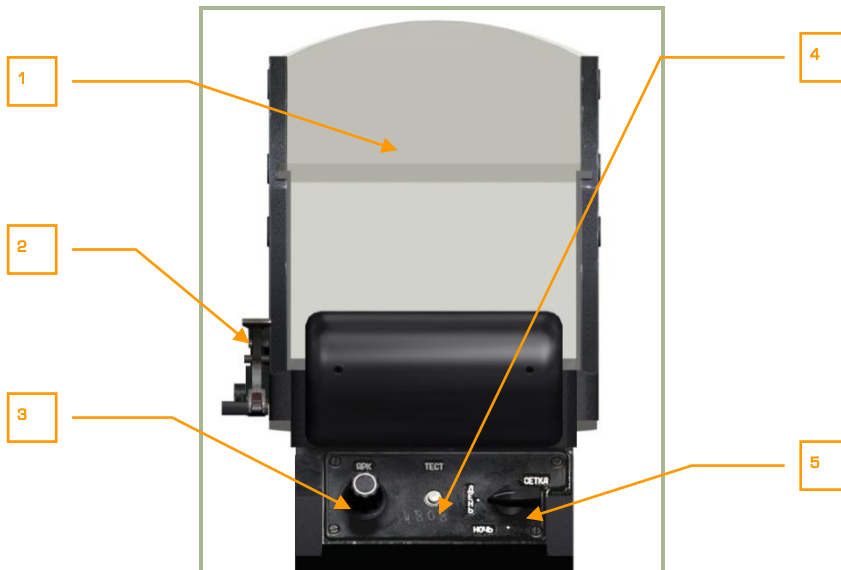

#### 4-1: Collimator head-up indicator (HUD)

1. Reflector glass
2. Color filter lever [H + RSHIFT]
3. HUD symbology brightness knob up [H + RCTRL + RSHIFT] and down [H + RALT + RSHIFT]
4. Self-test button [H + RALT + RCTRL + RSHIFT]
5. HUD mode selector [8 + RSHIFT]
  - **"ДЕНЬ"** (Day) – normal operational mode (green color symbols)
  - **"НОЧЬ"** (Night) – night mode (amber color symbols)

- "СЕТКА" (Reticle) – standby reticle mode

Filtering of HUD information is set by the "ОГР ИНФ – ПОЛН" (Rejected information – Full information) switch [S + RCTRL] on the Targeting Display Control Panel. When filtering is enabled, only targeting information is displayed.

The rotary brightness knob on the HUD panel controls the brightness of the HUD symbology when in full operating mode. Note that the HUD symbology will not appear immediately after a cold-start of the aircraft.

## FLIGHT AND NAVIGATION HUD INFORMATION

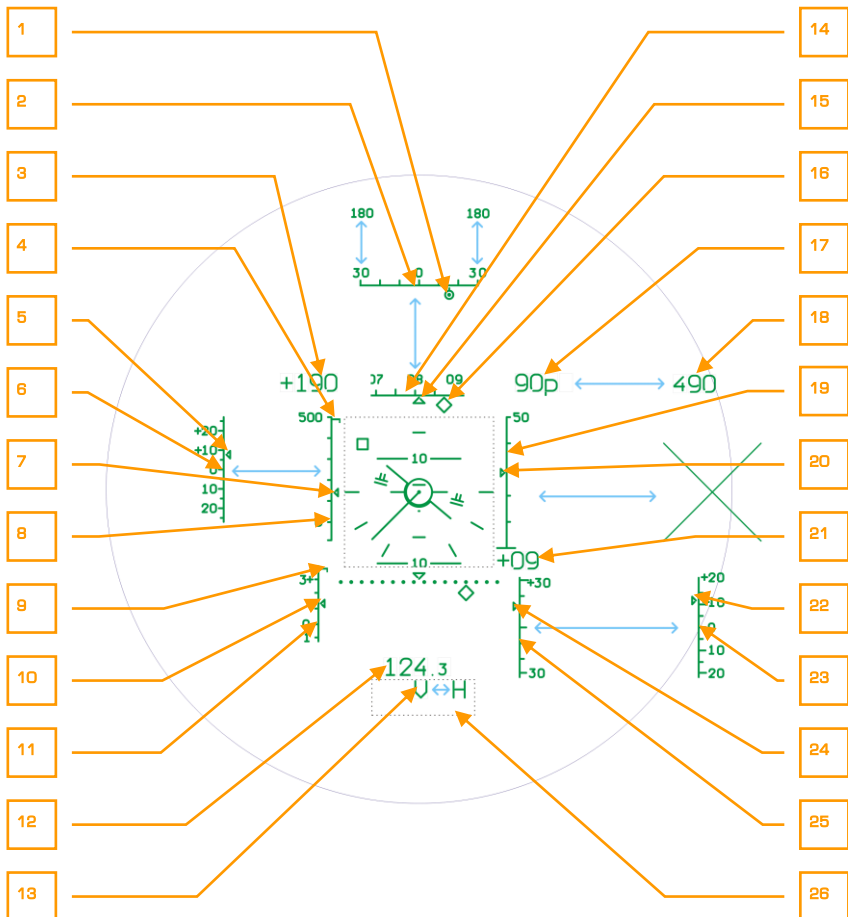

4-2: Display of Flight-Navigation data on the HUD (1)

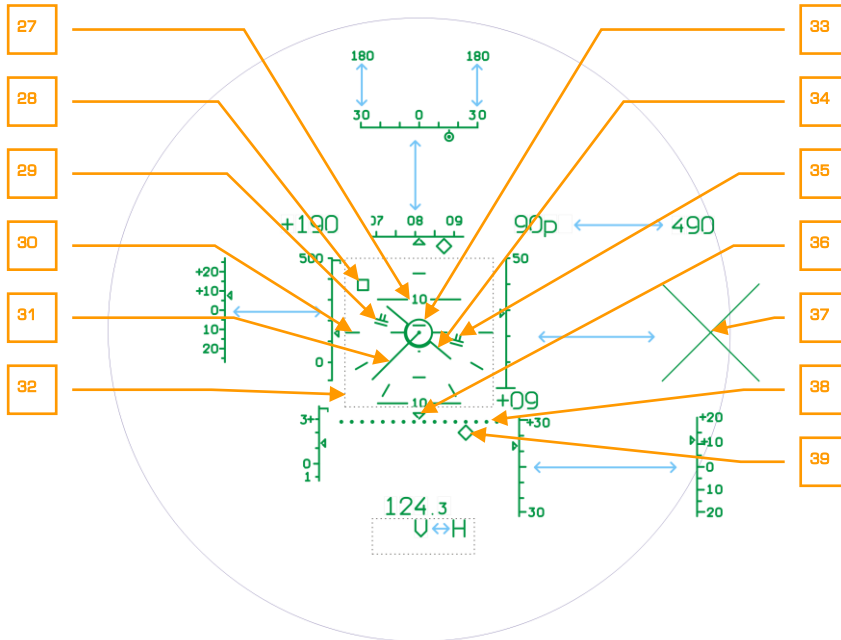

#### 4-3: Display of Flight-Navigation data on the HUD (2)

1. **Target Bearing Marker.** This small circle with a dot in the center is aligned with the Target Bearing Scale and indicates the angle off nose to the target. When this marker is in the center of the scale, the target is directly in front of the aircraft.
2. **Target Bearing Scale.** After a target has been designated, the Heading Scale changes to a Target Bearing scale that provides an angular measurement from off the nose of the aircraft. The center of the scale indicates directly in front of the aircraft and either end of the scale indicates 30 degrees left / right off the nose. When the target is greater than 30 degrees left / right off the nose, the scale will automatically change to be 180 degrees left / right. The position of the Target Bearing Marker on this scale indicates angular target direction off the nose.
3. **Ground Speed Numeric.** This is the digital indication of airspeed in regards to ground speed (the speed at which the aircraft is moving across the ground). When moving forward or backwards, a "+" sign precedes the number.
4. **Maximum Airspeed Marker.** When flying greater than 50 kph, the IAS scale will appear on the HUD. On the IAS scale is a small horizontal line that indicates the maximum safe airspeed. When reached or exceeded, the master caution light will light and a maximum speed tone is heard.
5. **Current Deviation from Assigned IAS.** See below.



6. **Scale of Deviation from Assigned IAS.** This index and scale appear when route mode is engaged. Assigned IAS is designated each time the trim button is pressed. After that, the deviation marker indicates deviation in km/h from the last trim assigned IAS. This indication consists of the deviation caret and the deviation reference scale.
7. **Current IAS Caret.** Running vertically along the IAS scale, this small caret indicates the aircraft's current Indicated Air Speed (IAS). The caret will flash when at or above maximum airspeed, which is indicated by the Maximum Airspeed Marker.
8. **IAS Scale.** Located along the left side of the HUD when the aircraft is flying at or greater than 50 kph, this scale goes from -100 to +500 and is used in reference to the Current IAS caret to indicate IAS.
9. **Maximum Load Factor (G) Marker.** Located at the top of the Load Factor Scale, this horizontal line indicates the maximum allowable load factor for the aircraft.
10. **Current Load Factor (G). Caret.** This small caret moves vertically along the Load Factor Scale and indicates the current load factor on the aircraft. If the caret reaches the Maximum Load Factor marker, the master caution light will activate and the maximum-G tone will be heard.
11. **Load Factor (G) Scale.** This vertical scale in the bottom left of the HUD indicates current load factor when in reference to the Current Load Factor caret. The scale represents +4 G at the top and -1 G at the bottom.
12. **Range.** Using the Shkval, the range to a location/target can be displayed if a weapon is selected and the sensor is un-caged.
13. **Warning Cue(s).** Various warnings and notices can be displayed in this area of the HUD. Please see the HUD Cue Descriptions below.
14. **Heading Scale.** Located at the top of the HUD, this horizontal scale rotates left and right such that the center of the scale indicates the aircraft's current heading in degrees.
15. **Current Heading Marker.** This marker is located at the center point of the Heading Scale and represents the aircraft's current heading.
16. **Desired Heading Cue.** When a navigation destination has been set from the PVI-800 control panel, a diamond will appear along the Heading Scale that represents the heading to the navigation point. If the Desired Heading Cue is aligned with the Heading Marker, then the aircraft is flying a direct course to the navigation point. If however the Desired Heading Cue is off to one side of the Heading Scale, the aircraft must be directed in that direction to reach the navigation point.
17. **Radar Altitude Numeric.** When aircraft altitude is at or below 50 meters, the radar altimeter indication will be displayed. This appears as a "p" next to the digital readout.
18. **Barometric Altitude Numeric.** When the aircraft is 50 meters above ground level, barometric altitude will be displayed in relation to altitude above sea level.



19. **Radar Altitude Scale.** When the aircraft is at or below 50 meters, a vertical radar altitude scale is displayed on the right side of the HUD. This scale ranges from 0 meters at the bottom to 50 meters at the top.
20. **Current Radar Altitude Caret.** Along the inside of the Radar Altitude Scale is the Current Radar Altitude Caret that moves up and down the scale to represent the aircraft's current radar altitude.
21. **Vertical Velocity Numeric.** This two-digit numeric indicates the positive (+) or negative (-) vertical velocity change of the aircraft in meters per second. For example: an indication of +03 would mean that the aircraft is gaining altitude at a rate of three meters every second.
22. **Current Deviation from Assigned Radar Altitude.** See below.
23. **Scale of Deviation from Assigned Radar Altitude.** This index and scale appear when route mode is engaged with altitude hold. An assigned altitude is set each time you release the collective brake (see Collective stick description). After you reach the desired altitude you release the brake on the collective and the current altitude will be set as the Assigned Altitude. After that, the deviation index indicates deviation from Assigned Altitude in meters.
24. **Current Vertical Velocity Caret.** Moving vertically up and down the Vertical Velocity Scale, this caret indicates the current vertical velocity rate of the aircraft. For example: if the caret is centered, it would indicate zero vertical change and if it were  $\frac{3}{4}$  up the scale it would indicate +15 meters per second.
25. **Vertical Velocity Scale.** In the lower right portion of the HUD is a vertical scale that measures the aircraft's rate of vertical velocity. The center of the scale marks zero change and the top and bottom represent +30 and -30 meters per second respectively. The scale works in reference to the Vertical Velocity Caret.
26. **Warning Cue Display** (not visible). Various warnings and notices can be displayed in this area of the HUD. Please see the HUD Cue Descriptions below.
27. **Pitch Scale.** Spaced every 10-degrees of pitch with intermediate five degree marks, the pitch scale is located centrally on the HUD and ranges from zero pitch (represented by a single dot) to 90 degrees.
28. **Hover Point Deviation Marker** (dynamic). When Hover mode is activated, this small, square marker appears on the HUD and represents the point on the ground when the mode was initiated. Depending on movement of the aircraft after Hover mode was initiated, the marker may move around the HUD to represent the aircraft's position in relation to that initial hover point. For example: if the square moves to the bottom of the HUD, it indicates that the aircraft has moved too far forward; if the square is off on the right side of the HUD, it would indicate that the aircraft has moved too far to the left of the hover point location. Keeping the marker in the center of the HUD within the Hover Point Reference Circle indicates the aircraft is maintaining the initial hover point location.
29. **Bank and Pitch Steering Cues** (rolled in proportion to roll input). If "ДИР УПР"– director control channel autopilot is selected with route mode, the Bank and Pitch Steering cues will appear on the HUD. These cues indicate the needed degree of bank and pitch to fly to the set navigation point from the



PVI-800 navigation panel. The cues appear as double-horizontal lines and they will be tilted in the direction the aircraft needs to bank to reach the navigation/target point.

30. **Bank Scale** (marked for 0°). Within the center of the HUD are bank indications for 0-degrees (level), 30-degrees, and 60-degrees.
31. **Velocity Vector**. When airspeed is below 50 kph, a velocity vector line is drawn from the center of the Aircraft Datum. This line points in the direction that the aircraft is traveling and the length of the line represents the aircraft's relative speed. The line will be longest when the aircraft is traveling at 50 kph in any direction and shortest when the aircraft is at or near a hover. The Velocity Vector line is a useful tool when used in conjunction with the Hover Point Deviation Marker to hold a battle position.
32. **Central Display Box** (not visible). This is the central area of the HUD that displays indications like the Pitch Scale and Aircraft Datum.
33. **Hover Point Reference Circle** (static). When Hover mode is initiated, a static circle is displayed in the center of the HUD. This circle represents the hover point.
34. **Aircraft Datum** (dynamic in bank). Located in the center of the HUD, the datum represents where the nose of the aircraft is pointed. The datum also rotates with bank angle in relation to the Bank Scale.
35. **Assigned Altitude Indicators** (climb/descend cue). If the "ДИР УПР"–director control channel autopilot is selected with altitude hold and route modes engaged, the Assigned Altitude Indicators will appear on the HUD. Extending up or down from the Bank and Pitch Steering Cues are two lines that indicate the needed collective setting to reach/maintain the assigned altitude.
36. **Cross Track Error (XTE) Reference Marker** (static). The marker is located above the center of the XTE scale and indicates the zero cross track error heading.
37. **Fire Inhibit Cross**. The large "X" cross appears over the HUD when the selected weapon is inhibited from firing. The most common reason for this inhibit is a weapon's minimum range.
38. **XTE Scale**. This dotted line across the bottom of the HUD provides a reference for the XTE Steering Cue. The further the steering cue is from the center of the Scale (marked by the Reference Marker), the greater the aircraft is off the planned course line to the selected steerpoint.
39. **XTE Steering Cue**. This diamond-shaped symbol under the XTE Scale moves horizontally across it to indicate cross track error along the course to the steerpoint. Having the cue underneath the Reference Marker indicates the aircraft has zero cross track error.

**HUD Cue Descriptions:**

1.	Н	Ground collision warning
2.	V	Maximum speed warning
3.	ОТ	Processing target point
4.	РЕЗ-Н	Navigation control computer is processing
5.	ИД	Laser range-finder is active
6.	ТА	Auto-tracking engaged by the electro-optical tracking system
7.	П	'Memory' mode (Auto-Tracking prolongation, e.g. LOS obstruction)
8.	С	Launch authorized ('shoot') cue
9.	ИУ	Beam-riding laser channel is active
10.	ПАУЗА	'PAUSE' cue - cooling cycle of the laser range-finder in the Target Marker ("ПМ") targeting mode
11.	РУ-ТА	Electro-optical tracking system operating in reserve control mode
12.	ТА-ИД	Auto-Tracking engaged and the laser range-finder is active
13.	ТА-ИУ	Auto-Tracking engaged and the beam-riding laser channel is active
14.	ТРЕНАЖ	Simulation mode
15.	КОРР	Coordinates updating via the I-251 (И-251) Shkval electro-optical targeting system (depression of the 'DESIGNATE' ("ЦУ") button)
16.	<u>КУРС</u> НВ	Course update error: Invalid heading entry in the Manual Heading ("ЗК") mode or invalid magnetic heading in the Magnetic Heading ("МК") mode
17.	<u>ИКВ</u> ЭП	Inertial Navigation Unit (INU) emergency warm-up
18.	<u>ИКВ</u> УВ	Inertial Navigation Unit (INU) fast warm-up
19.	<u>ИКВ</u> НВ	Inertial Navigation Unit (INU) normal warm-up
20.	<u>ИКВ</u> ТВ	Gyroscopic calibration for 0°
21.	<u>ИКВ</u> ВГП	Gyroscopic calibration for 180° (flashing cue)



### HUD Flight and Navigation Information Regardless of Combat Mode:

Data	Data Symbols when in Navigation Mode	Indication Range and Operation
Bank $\gamma$	All modes:  Stabilization and control: - Route (ALT, RALT hold, DH, DTA)  - Hovering  - Descent	Rotation of aircraft datum (34). Clockwise - right bank.  Scale graduation value of 30°
Pitch $\theta$	All modes	Pitch scale (27) moving. Dive to go up.  Scale graduation value of 5°
Current Heading $\psi$	All modes	Heading scale (14) moves relative to current heading marker (15).  Movement is to left with right turn.  Indication of $\pm 15^\circ$ of heading scale segment around current heading marker.  Scale graduation value of 5°
Radar (true) Altitude $H_r$	All modes	From 0 to 50 m altitude scale index (20) on a scale (19).  Increase of altitude bottom to top. Scale range of 0...50 m. Scale graduation value of 10 m.  From 50 to 300 m altitude indication on the radar altitude numeric (17). Scale (19) and index (20) does not appear.  Above 300 m radar altitude, the numeric (17) is replaced with barometric altitude numeric (18).
Barometric Altitude	All modes	Barometric altitude numeric (18) above 300 m or with radio altimeter malfunction.
Desired Radar Altitude Deviation $\Delta H_r$	Stabilization and control:  - Route RALT hold  - Hovering	Movement of desired radar altitude deviation index (22) on the scale (23).  A positive desired radar altitude deviation above the center point on the scale.  Range scale of $\pm 20$ m, scale graduation

		<p>value of 5 m.</p> <p>With turn on either of pointed modes scale (25) is replaced with scale (23).</p>
Vertical Velocity $V_y$	Stabilization and control: - Descent	<p>Movement of current vertical velocity index (24) on the scale (25).</p> <p>Climb is indicated vertically up.</p> <p>Vertical velocity numeric (21).</p>
G Meter $n_y$	Stabilization and control: - Route, RALT stabilization  - Descent	<p>Movement of current load factor (G) index (10) on the scale (11).</p> <p>Positive G moves up on the scale.</p> <p>Range scale of -1...+3 g.</p> <p>Scale graduation value of 1.</p>
IAS $V_{np}$	All modes except route autopilot (desired speed stabilization)	<p>Movement of current IAS index (7) on the scale (8).</p> <p>Increased speed indicated as up on the scale.</p> <p>Range scale of 100...500 km/h.</p> <p>Scale graduation value of 100 km/h.</p>
Desired IAS Deviation $\Delta V_{np}$	Route mode	<p>Movement of desired IAS deviation index (5) on the scale (6).</p> <p>A positive desired IAS deviation is above the center point on the scale.</p> <p>IAS scale (8) is replaced with desired IAS deviation scale (6) in route mode.</p> <p>Range scale of +25-20 km/h.</p> <p>Scale graduation value of 5 km/h.</p>
Ground Speed $W$	All modes	<p>Ground speed indication (3).</p> <p>With speed below 50 km/h, velocity vector (31) appears.</p>
Hover Point Drift	Hovering, descent	<p>Movement of hover drift marker (28) is relative to the hover point reference circle (33).</p> <p>Movement of hover drift marker to the right indicates that the helicopter has drifted to the left.</p> <p>Movement of hover drift marker forward of center indicates that the</p>

		helicopter has drifted back.
XTE Deviation	Route, XTE	Movement of XTE deviation index (39) on the scale (38).  Index movement to right indicates XTE deviation to the right.  Scale graduation value of 40 m.
Desired Heading DH	Stabilization and control: - route DH, DTA	Movement of heading steering cue (16) on the scale (14).
Relative Target Angle	Stabilization and control: - Ingress mode - Combat mode (after engaging Shkval targeting system)	With Ingress mode on.  Heading scale is replaced with relative target angle scale (2) with $\pm 30^\circ$ range with a relative target angle cue (1).  Relative target angle cue movement to the right indicates a turn to right is needed to align target.  Scale graduation value of $10^\circ$ .
Bank Director Control	Route DH, DTA - Hovering - Descent	Rotation bank and pitch steering cues (29) around aircraft datum (34)  For clockwise rotation, move cyclic stick to right
Pitch Director Control	Route DH, DTA - Hovering - Descent	Movement of bank and pitch steering cues (29) around aircraft datum (34)  For upward movement, pull back on the cyclic stick.
Altitude Director Control	Route RALT hold - Hovering - Descent	Appearance and length of the altitude steering cues (35) over and under the bank and pitch steering cues (29).  Increasing size of altitude steering cues above the bank and pitch steering cues indicates the collective needs to be increased.
Ground Proximity Warning	All modes	Displayed in the warning cue display box (26) as a flashing H symbol.
Maximum Limit Speed Vmax дон	All modes	Displayed in the warning cue display box (26) as a flashing V symbol.



The specific type of HUD indication for a unique combat mode in relation to the selected weapon system mode is discussed in the appropriate combat application chapter.

## The I-251 “Shkval” Electro-Optical Targeting System

The I-251 (И-251) “Shkval” electro-optical targeting system is designed to detect targets via electro-optical imagery that provides 7x and 23x magnification under visual, daylight conditions. It can then process that information and use it for automated targeting and weapons delivery.

As part of the K-041 Weapons and Navigation Control System, the targeting system provides:

- Target detection via the IT-23 (ИТ-23) television monitor (TVM) and automatic, inertial, or manual (by use of a hat switch) tracking of moving and stationary ground targets; this includes small targets such as tanks.
- Supports guidance of Vikhr ATGM against moving and stationary targets.
- Targeting and employment of the on-board automatic cannon in either slaved or boresighted modes of operation.
- Targeting and employment of unguided rockets.
- Calculation of range, azimuth and elevation angles of designated point (Target Point).
- Entry of a target’s angular coordinates (Reference Point) and range information into the Weapons and Navigation Control System for the display of targeting information on the TVM. This can also be used for automatic target tracking and weapons employment, as well as correction of helicopter INS coordinates and acquisition of target coordinates (Target Point).
- Visual display of the target area on the TVM at 7x or 23x magnification with superimposed targeting information.

The system is electro-optical-based and is responsible for displaying target imagery on the TVM. The system has two selectable fields of view: wide angle (2.7 x 3.6)°, with a 7x magnification factor, and narrow angle (0.7 x 0.9)°, with a 23x magnification factor.

Selection of the wide field of view and narrow field of view is made via the “ШПЗ-УПЗ” (Wide FOV-Narrow FOV) switch [+ ] and [- ] on the Collective.

Information and symbology used for targeting and helicopter control is superimposed over the target imagery on the TVM.

Image quality can be adjusted via the “ЯРКОСТЬ” (brightness) [ ] + RALT + RCTRL and [ ] + RALT + RCTRL and “КОНТРАСТ” (contrast) [ ] + RCTRL + RSHIFT and [ ] + RCTRL + RSHIFT knobs and selection between black or white symbol overlay is made with the “ФОН БЕЛЫЙ – ЧЕРНЫЙ” (tone white – black) [B + RCTRL + RSHIFT] switch on the Targeting Display and Control Panel.

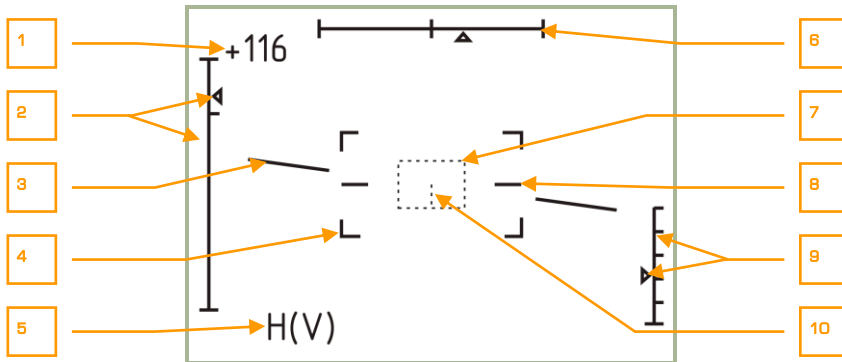

#### 4-4: Display of the IT-23VM (MT-23BM) TVM in target search mode (Wide FOV)

1. Current airspeed
2. Line of sight elevation scale and marker (+15°...-80°)
3. Artificial horizon
4. Narrow FOV (0.7 x 0.9)° boundary markers
5. Flashing warning cues: "H" - ground collision and "V" - maximum airspeed
6. Line of sight azimuth scale and marker (±35°)
7. Tracking gate
8. Zero bank (wings-level) reference lines
9. Scale and marker of radar altitude (displayed below 50 m. of radar altitude)
10. Centerline of the tracking gate (displayed if the tracking gate size is increased four or more settings over the minimum)

The TVM stabilization device is used to compensate for aircraft roll and pitch. This stabilization and control system is designed to help you slew the electro-optical system onto the target (Target Point) and maintain gyro-stabilization while the aircraft is in motion.

The system's line of sight can be controlled by the Helmet Mounted Sight (HMS), the hat switch on the Cyclic Control Stick or by the electro-optical tracking system. The system's line of sight corresponds to the center of the TVM video picture and is linked to the target marker on the Head Up Display (HUD). The sensor's line of sight field of view (FOV) is ±35° in azimuth and +15° / -80° in elevation. When the sensor is in stand-by, the line of sight is caged and boresighted along the aircraft's longitudinal axis.

For expanded target search capability, the 'SCANNING' mode conducts automatic scanning in the horizontal axis ±10° from the initiation point. The scan rate is adjustable from 0.25°/sec to 3°/sec by using the Shkval optics scan rate dial on the right panel, below the autopilot controls.

When the "ЦУ" (Designate) [O] button on the Cyclic is pressed, the sensor is uncaged from boresight and the system becomes gyro-stabilized on the point in the center of the



display. If this point's azimuth is greater than  $\pm 35^\circ$  (when targeting via the HMS) the line of sight moves to its limit of  $\pm 35^\circ$ . This can then be followed by an automated Turn to Target or a manual maneuver towards the designation point. As the point's azimuth becomes less than  $\pm 35^\circ$ , the line of sight begins tracking the point's azimuth as directed by the HMS. Initial (search) line of sight placement and target detection is generally performed in the Wide FOV mode by positioning the target marker on the HUD over the point of interest (using the hat switch or HMS). Target identification is then performed in the Narrow FOV mode. Pressing the "СБРОС" (Reset) [BACKSPACE] button on the Weapon Status and Control Panel cancels the stabilization settings and resets the system to stand-by (sensor cued to boresight).

The electro-optical tracking system ("TA") provides automatic tracking of moving and stationary targets placed within the tracking gate of the TVM. After detection and identification of a target on the TVM at the stabilization point, maneuver the aircraft or use the hat switch on the Cyclic to place the target in the center of the TVM within the tracking gate. Next, adjust the size of the tracking gate to fully enclose the target by using the "ПАМКА М – Б" (TV target frame Increase – Decrease size) [I] and [J] according to the range to and size of the target. Automatic target tracking is enabled when the "АВТ ЗАХВ" (Lock) [ENTER] button on the Collective is pressed and released; this initiates the Auto-Tracking mode and maintains line of sight to the target throughout the engagement (assuming the target stays within  $\pm 35^\circ$ ). When in Auto-Tracking mode, the size of the tracking gate is automatically adjusted. This is accomplished by comparing the target's original image (committed to memory upon Auto-Tracking initiation), with the target's current image. The difference between the target's original image and current image is recognized by the system and processed for correlation.

Several cues are provided on the TVM regarding this process:

- "ТГ" cue when the sensor line of sight has been slewed from boresight and is now ground stabilized on a point.
- "ТА" cue when the system has locked on to a target and has initiated auto-tracking.
- "П" cue when the sensor is in memory mode after losing a lock.

During Auto-Tracking, the tracking gate may be unstable and 'breathe' around the target due to changes in the target's image; however, the target line of sight will remain in the center of the TVM image and provides a more accurate target location direction.

After a target is being tracked in Auto-Tracking mode, the sensor slew controls will be inoperative. This is to prevent unintended cancellation of an Auto-Track. To regain sensor slew control, you must first cancel the Auto-Track. You can adjust the position of the tracking gate by holding the "АВТ ЗАХВ" (Lock) button down while slewing the hat switch. Releasing the "АВТ ЗАХВ" (Lock) button automatically re-engages Auto-Tracking.

If optical contact with a target is lost during Auto-Tracking (for example: if the target goes behind a building), the "ТА" cue on the TVM changes to a "П" cue (Russian for "memory"). The electro-optical tracking system stores the direction and motion parameters of the line of sight and initiates a tracking prolongation for up to three seconds. If the target reappears within this time, Auto-Tracking will be re-established. If however contact is lost for over three seconds, Auto-Tracking is disabled ("ТА" cue disappears) and the system automatically engages Inertial Tracking by utilizing data from the onboard computers based on range to target, coordinates and helicopter movement.

Inertial Tracking (“**ПКС**”) is enabled the first time you depress the “**АВТ ЗАХВ**” (Lock) button on the Collective and range to target/point information is then provided. This data is corrected by a summation of inertial and automatic tracking parameters. When Auto-Tracking is disengaged, Inertial Tracking is disabled as well. Inertial Tracking allows the pilot to slew the line of sight in a ground stabilized mode without having to continually press the “**АВТ ЗАХВ**” (Lock) button. The sight slew rate depends on its inertial motion, which is translated to you as unequal steering rates in different directions.

All tracking modes of the electro-optical tracking system are disengaged when the “**СБРОС**” (Reset) button is pressed on the WCS Control Panel.

The laser-range finder of the targeting system measures slant range to target and is directed toward the same point as the line of sight of the electro-optical targeting system.

If the “**АС-ПИМ**” (Auto-Tracking – Gun sight) switch [P] on the Targeting Mode Control Panel is set to “**АС**” (Auto-Tracking) and the “**ППУ**” (Moving canon – automatic weapons mode) mode is selected, the laser range-finder is activated with the first depression of the “**АВТ ЗАХВ**” (Lock) button and remains active for three seconds. The laser range-finder also activates when Auto-Tracking mode is entered and will fire from three or eight seconds, depending on the range and closure rate to the target. If the “**АС-ПИМ**” (Auto-Tracking – Gun sight) switch is set to “**ПИМ**” (Gun sight), the laser is activated with every depression of the “**АВТ ЗАХВ**” (Lock) button and remains active until the button is released. After this, the “**ПАУЗА**” (Pause) cue is displayed on the HUD, as well as the time remaining until another laser firing is possible. Laser firing is prevented when in ‘PAUSE’ mode and the ‘PAUSE’ time is generally equal to the time of the last firing.

The “**ИД**” (Range-finder) cue will appear on the HUD while the laser range-finder is active.

The beam-riding laser channel creates a control zone along the helicopter-target line of sight for the guidance of the Vikhr ATGM. It is created by scanning two lasers along the horizontal and vertical axis to form the control zone, which is approximately 7 m in radius starting 100 m in front of the helicopter and extends to the target. Missile guidance commands are transmitted inside the control zone relative to the center line of sight and guides the missile’s trajectory within it. The size of the control zone relative to the missile is maintained constant throughout the missile’s flight by algorithmically narrowing the emission angles as the missile travels away from the helicopter.

The laser beam channel is formatted by a special scanner and laser transmitter. A single missile is launched with a press of the weapon release [SPACE + RALT] button; the scanner will start scanning; and with the missile launched, the laser transmitter will start working. If two missiles are launched in salvo, the first missile launched starts the scanner, but the laser transmitter will not start working until the second missile is launched.

Manual slewing control of the targeting system allows you to align the target line of sight with the electro-optical targeting system. Slewing of the system’s line of sight is accomplished via the “**МЕТКА**” (Target Marker) hat switch on the Cyclic Stick [.] , [.] , [/] and [;].

The range of the laser range-finder can be set from 10 km to 0.6 km.

To maintain Auto-Tracking, the helicopter is limited to  $\pm 45^\circ$  in bank and a rate of  $\pm 20^\circ/\text{sec}$ . in pitch and yaw.



## THE HELMET-MOUNTED SIGHT (HMS) SYSTEM

The Helmet-Mounted Sight (HMS) determines the angular coordinates of the line of sight to a visually acquired target (tracked via the pilot's head position) and then outputs targeting commands to the K-041 Weapons and Navigation Control System. This in turn can cue the electro-optical targeting system to the target. The HMS directs the targeting system according to the line of sight coordinates of the helicopter's coordinate system.

When integrated with the Weapons and Navigation Control System, the HMS provides preliminary guidance to the target for employment of ATGMs, the onboard automatic cannon, or unguided rockets.

The HMS system includes:

- The NVU-2M helmet-mounted sighting device that is integrated into the pilot's helmet (consisting of three illuminators/projectors and the monacle sight for display of targeting information).
- Scanning devices that are adjacent to the HUD and determine the position of the sight's illuminators/projectors.

HMS control is incorporated into the K-041 Weapons and Navigation Control System. The Weapons and Navigation Control System outputs the following commands to the HMS system: Built-in Test (BIT), Helmet, Target Lock, and Launch Authorized. Upon receiving the 'Helmet' command, the HMS outputs angular coordinates, as well as the Active and Turn to Target cues.

The HMS is controlled from the K-041 Weapons and Navigation Control System and the system is activated with the "K-041" switch [D + LSHIFT] on the WCS Control Panel. From the WCS panel, the "ОБЗ" (Helmet) switch [H] is used to activate the system. Display brightness can be adjusted with the "ЯРКОСТЬ" (Brightness) knob [[ + RALT + RCTRL + RSHIFT] and [ ] + RALT + RCTRL + RSHIFT] on the WCS Control Panel. Pressing the "ЦУ" (Designate) button [O] on the Cyclic automatically slews the targeting system to the angular coordinates provided by the HMS. However, if a TP is selected on the PVI-800 and the HMS is activated, pressing the designate command will slew the targeting system to the TP and not to the designated HMS point.

Targeting cues from the Weapons and Navigation Control System are displayed on the helmet sighting monacle:



## HMS Indications

### Operative Mode

Indicates the normal operative mode of the HMS.

Two solid, concentric circles.

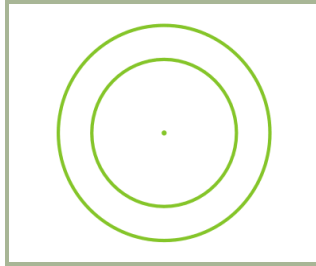

### 4-5: HMS Operative

Conditions:

- Automatic weapon system control mode enabled (AC).
- HMS within Shkval's gimbal limits.
- Shkval's tracking system doesn't engage.
- "ЦУ" (Uncage Shkval, designate target) button on the cyclic stick is not pressed.

### PROCESSING

Indicates that the HMS is processing targeting system coordinates.

Flashing (2 Hz) crosshairs are surrounded by two solid, concentric circles.

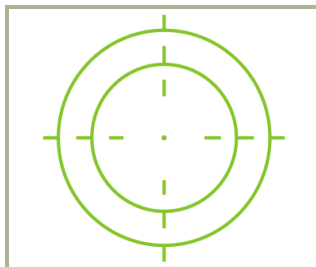

### 4-6: HMS Processing

Conditions:

- Automatic weapon system control mode enabled (AC).

- HMS in Shkval's gimbal limits.
- Shkval's tracking system is not engaged.
- "ЦУ" (Uncage Shkval, designate target) button has been pressed and the displacement angle between HMS and Shkval LOS is more than 2°.

## LOCK

Indicates that processing is complete and the Shkval system is in auto-tracking mode.

Solid crosshairs are surrounded by two solid, concentric circles.

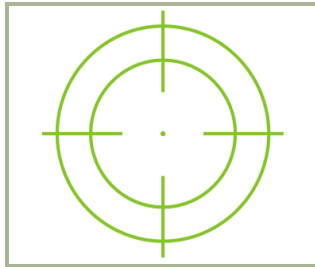

### 4-7: HMS LOCK

There can be one of two conditions:

#### Set 1:

- Automatic weapon system control mode is enabled (AC).
- HMS in Shkval's gimbal limits.
- "ЦУ" (Uncage Shkval, designate target) button has been pressed and the displacement angle between the HMS and Shkval LOS is less than 2°.
- Shkval has been un-caged and cued to the HMS. With release of the "ЦУ" (Uncage Shkval, designate target) button, Shkval transitions to "ТГ" (Tracking system ready) mode with laser ranging.

#### Set 2:

- Automatic weapon system control mode enabled (AC).
- HMS in Shkval's gimbal limits.
- TA (Shkval's tracking system engaged).

## LAUNCH AUTHORIZED

Indicates that weapon may be launched.

Solid crosshairs.

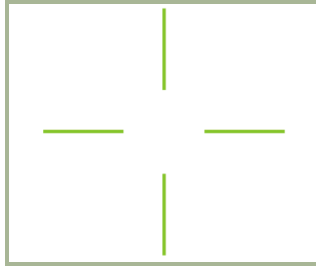

#### 4-8: HMS LAUNCH AUTHORIZED

Conditions:

- Automatic weapon system control mode enabled (AC).
- HMS in Shkval's gimbal limits.
- Launch authorized.

#### OVER-LIMIT

Indicates that the HMS line of sight is beyond the Shkval's gimbal limits ( $\pm 30^\circ$ ).

Flashing (2 Hz) concentric circles.

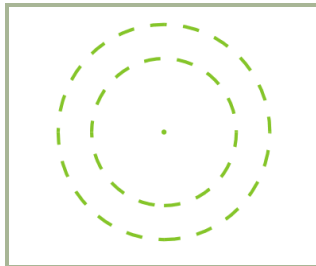

#### 4-9: HMS OVERLIMIT

Conditions:

- Automatic weapon system control mode enabled (AC).
- HMS is beyond the Shkval's gimbal limits ( $\pm 30^\circ$ ).
- "ЦУ" (Uncage Shkval, designate target) button on the cyclic stick is not pressed.

#### TURN TO TARGET

If a target is beyond of the Shkval's gimbal limits ( $\pm 30^\circ$ ), it is required to maneuver to bring the target within the targeting system's scan limits. With "АДВ" (automatic auto turn to target) mode enabled, the helicopter will orient toward the target.

Flashing (2 Hz) crosshairs and concentric circles.

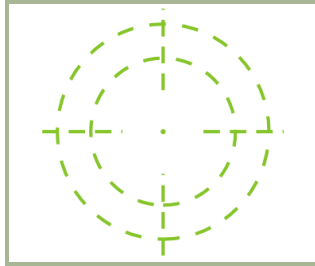

#### 4-10: HMS TURN TO TARGET

Conditions:

- Automatic weapon system control mode enabled (AC).
- HMS is beyond the Shkval's gimbal limits ( $\pm 30^\circ$ ).
- "ЦУ" (Uncage Shkval, designate target) button is pressed.
- "АДВ" (Automatic turn to target) mode active.

#### HMS Inoperative

HMTD is not visible.

Either of the conditions:

- HMS is beyond the HMS sensor limits ( $\pm 60^\circ$ ).
- "ПМ" (Gun sight) is not in automatic mode.



5

**FLIGHT  
PREPARATION**

## 5 FLIGHT PREPARATION

Flight preparation and system checks are conducted in the following conditions:

- The helicopter is armed and fueled according to the flight task.
- Electrical power is disabled and disconnected from the helicopter; PrPNK preparations have been performed according to the flight task and initial flight data is entered into the PNK (by default the preparation is complete when the data is entered).
- The route and the flight plan from the mission editor are loaded in the ABRIS (by default).

### Systems Activation and Checks

When performing start-up preparations and checks, an external power unit should be the source of electrical power. In case no ground power unit (GPU) is available, it is possible to use the onboard batteries (with restrictions).

- Flip up the **"АКК1"** (Battery 1) cover and switch and the **"АКК2"** (Battery 2) cover and switch.
- Check that the **"ПРЕОБР АВТ – РУЧН"** (Electrical power converter auto – manual) switch is in the **"ПРЕОБР АВТ"** (Auto) position.
- Turn on the **"АВСК"** (Intercom).

Enabling AC and DC GPU:

- Turn on DC power, **"=ТОК АЭР ПИТ"** (Ground DC power) switch.
- Turn on AC power, **"~ ТОК АЭР ПИТ"** (Ground AC power) switch.

Turn on the EKRAN system serviceability check:

- Set the **"ВМГ ГИДРО ЭКРАН – ОТКЛ"** (Hydraulics/transmission group and EKRAN power supply) switch on the rear panel to the down position. The EKRAN display will illuminate for a short time and the **"ЭКРАН ОТКАЗ"** (EKRAN FAILURE) signal will go off.
- Press and release the MWL button and the EKRAN will display the **"САМОКОИТ"** (SELFTTEST) message. If the system is serviceable, the message will be replaced by the **"ЭКРАН ГОДЕН"** (EKRAN READY) message after five seconds.

Check the Emergency Warning System (EWS) and the lighting systems:

- Press the **"КОНТРОЛЬ СИГНАЛИЗАЦИИ"** (Warning, Cautions and Advisory lamps test) button on the left forward panel. All lights should then illuminate. Release the Warning, Cautions and Advisory lamps test button and all lights should return to their initial status.
- When flying at night, turn on the following lights:



- **“ПОДСВЕТ ПУЛЬТЫ”** (Gauges illumination)
- **“ПОДСВЕТ АГР ПКП”** (ADI and HSI illumination)
- **“АНО КОД”** (Navigation lights) (overhead panel)
- **“КОНТУР ОГНИ”** (Tip lights)
- **“СТРОВ ОГНИ”** (Formation lights)
- **“ПРОБЛЕСК МАЯК”** (Anti-collision light)
- **“ПОСАД ФАРЫ”** (Landing-search light) (center panel, bottom)

When using the night vision goggles, turn on the adaptive blue cockpit illumination **“ПОДСВЕТ ПРИБОРЫ”** (Cockpit night illumination) before takeoff and turn-off the white illumination **“ПОДСВЕТ ПУЛЬТЫ”** (Gauges illumination) and **“ПОДСВЕТ АГР ПКП”** (ADI and HSI illumination).

## ABRIS Activation

Turn on the power switch on the ABRIS control panel.

## PrPNK Preparation

Preflight PNK preparation procedures:

1. Initial data input. By default, the initial data input is from the mission file (.miz) created in the mission editor
2. Data entry check (according to mission)
3. INU alignment. Normal preparation is selected by default
4. Course correction (if necessary)

Set the **“K-041”** switch to the on position (located on the Targeting mode control panel)

Set the PVI mode selector to the **“РАБ”** (Normal operation) position.

It is not generally necessary to edit the flight plan created in the mission editor and you can proceed to the next preparation step – turning on the weapon control system

The flight plan (route) editing procedure is listed below.

If it is necessary to edit the existing flight plan or create a new one, it should first be created in the ABRIS.

## Inputting waypoint coordinates into the PNK

1. From the ABRIS, load the flight plan you wish to program into the PNK and select the Flight Plan sub-mode for selecting WP coordinates.
2. Set the PVI mode selector to the **“ВВОД”** (Enter-Edit) position.



3. From the PVI, enter WP (AF, TP, Fix point) sub-mode by pressing the **"ППМ"** (WP) (AF, TP, Fixed point) push-button. This will then illuminate the PVI display and indicate the number of pre-programmed points.
4. Press the push-button on the PVI-800 keypad that corresponds to the desired WP (AF, TP, or Fixed point) number. This will then display that number on the WP Waypoint display and the AF, OP, REF number will appear on the lower display.
5. From the PVI panel, enter the coordinates of the first point using the keypad.
  - Enter the geographic latitude positive-negative with the 0 «+» or 1 «-» buttons (the entire territory modeled in the game has positive latitude and longitude). The «+» sign is not displayed during input.
  - Sequentially enter the digits of the geographic latitude with decimals. The value of the latitude is displayed on the upper PVI display window.
  - Enter «+» sign for the geographic longitude with the 0 button. The «+» sign is not displayed during input.
  - Sequentially enter the digits of the geographic longitude with decimals. The value of the longitude is displayed on the lower PVI display window.
6. Once you have entered the latitude and longitude values, the **"ВВОД"** (Enter) push-button will illuminate.
7. Make sure the entered data is correct and then press the **"ВВОД"** (Enter) button.
8. In case of data entry error, press the **"СБРОС"** (Reset) button and repeat the process of coordinate input of a given point.
9. To disengage the WPs (AF, TP, Fixed point) sub-mode, press the **"ППМ"** (WP) (AF, TP, Fixed point) push-button again and the button illumination will extinguish.
10. Using this procedure, use the data from the ABRIS to enter the coordinates of all required WPs, AFs, TPs, and Fix points.

In the ABRIS, the coordinates of any point of the surface can be determined by using the cursor in INFO mode (NAV→MAP→INFO)

## Changing the WP sequence

If you wish to change the WP sequence or add a new WP in the current route, the following steps are required:

1. Set the PVI mode selector to the **"РАБ"** (Normal operation) position.
2. Set the **"ЗК-ЛЗП"** (Desired Heading – Desired Track Angle) switch on the Autopilot panel (right side panel) to the **"ЗК"** (DH) position.
3. Press the **"ППМ"** (WP) push-button on the PVI.





4. Using the PVI keypad, select the WP number selected as initial. After doing so, the number of the pre-programmed WP is displayed on the Waypoint display.
5. Press the **"ВВОД"** (Enter) button and the initial WP is loaded in the PNK.
6. Repeat this procedure for the rest of the WPs in the new sequence.
7. After inputting the last WP, press the **"ППМ"** (WP) push-button again. The WP sequence will then be saved in navigation computer memory.

## Activating the Weapons Control System

Turn on the **"СУО"** (Weapon System) switch on the wall panel.

## ADF Activation and Check

Make sure that the channel selector is positioned to correspond to the inner and outer NDBs of the airfield you are taking off from.

- From the **"ПРИВОД Р/С. БЛИЖН-АВТ-ДАЛЬН"** (NDB's INNER-AUTO-OUTER beacon mode) switch (central panel), set the switch to the **"БЛИЖН"** (INNER) (by default it's in AUTO) position.
- From the ADF panel, set the **"АНТ-КОМП"** (Antenna – Compass) ADF mode switch to the **"АНТ"** position to receive Inner NDB identification signal broadcast (once every 15 seconds).
- Set the **"АНТ-КОМП"** (Antenna – Compass) ADF mode switch to the **"КОМП"** position and make sure that the bearing needle on the HSI points to the Inner NDB.
- To confirm ADF operation with the outer NDB, set the **"БЛИЖН – АВТ – ДАЛЬН"** (INNER – AUTO - OUTER) switch to the **"ДАЛЬН"** (OUTER) position.

With ADF checks complete, leave the **"ПРИВОД Р/С. БЛИЖН-АВТ-ДАЛЬН"** (NDB's INNER-AUTO-OUTER beacon mode) switch in the **"ДАЛЬН"** (OUTER) position.

## UV-26 IRCM Dispensing Program Preparation

Set the UV-26 IR Counter Measures (IRCM) deployment system according to the flight task and expected threats as follows:

- Turn on the UV-26 with **"УВ-26 ВКЛ – ОТКЛ"** (Countermeasures system power) switch (rear panel, bottom part).
- Set the **"НАЛИЧИЕ – ПРОГР"** (Quantity-program) switch (overhead panel) to the **"ПРОГР"** (Program) position.
- With the **"СЕРИЯ"** (Number of flare sequences) button, set the number of flare sequences.
- With the **"ЗАЛП"** (Salvo) button, set the number of flares to be released in a single program sequence.



- With the **“ИНТЕРВАЛ”** (Interval), set the time-delay between flare release settings.
- Set the **“НАЛИЧИЕ – ПРОГР”** (Quantity-program) switch to the **“НАЛИЧ”** (Quantity) position to control the flares remaining.

# ENGINE START AND POWER TESTS PROCEDURES

## Preparation for Start-up

### Enable electrical power

From the electrical power control panel, you need to supply AC and DC power. This can be done either with the on-board batteries (battery 1 and battery 2) or from ground power outside the aircraft.

#### To use the on-board batteries:

Set the **"ТОК АКК1"** battery 1 and battery 2 switches to up.

#### To use ground power:

##### Turn on **"АВСК"** switch to provide power to the SPU-9 intercom.

First you will need to radio the ground crew to hook up an external power generator. To do so, first set the intercom dial on the SPU-9 radio panel to the **"НОП"** position. This will provide a communication link with the ground crew. Next, open the radio communication window by pressing the [N] key and select: Maintenance → Ground Elec Power... → On. With communication established, set the **"ТОК АЭР ПИТ"** ground DC power switch to on and the **"АЭР ПИТ"** ground AC power switch to on.

#### Press indicator lamp test button and check lamps.

### Check exhaust gas temperature (EGT) indicator

Located over the EGT gauge, press the **"НЕ РАБОТ"** (EGT check with stopped engines) button. This should show more than 800°C on the EGT gauges.

### Check fire extinguishing system

The fire extinguisher system controls are located on top of the right panel.

1. Move the **"ОГНЕТУШ – ОТКЛ – КОНТР"** (Fire extinguisher WORK – OFF - CHECK) to the test position.
2. Set the **"СИГНАЛИЗ"** (Fire signalling) switch to on.
3. Set the **"КОНТР ДАТЧИКОВ"** (Fire warning sensor group tests) switch to the **"1ГР"** (1<sup>st</sup> group) position. If the system is operating normally, the following lights should illuminate: **"ПОЖАР ЛЕВ ДВИГ"** (Left engine fire), **"ПОЖАР ПРАВ ДВИГ"** (Right engine fire), **"ПОЖАР ГИДРО"** (Hydraulics fire), **"ПОЖАР ВЕНТИЛ"** (Oil cooling fan fire), **"ПОЖАР ВСУ"** (APU fire). These warning lights are located on the wall panel. On the left forward panel, the MWL and **"ПОЖАР"** (Fire) lights will illuminate.
4. Set the **"КОНТР ДАТЧИКОВ"** (Fire warning sensor group tests) switch to the neutral position.



5. Turn off and on the **“СИГНАЛИЗАЦИЯ”** (Fire signaling) switch and all warning lights on the right side panel should turn off.
6. Repeat the procedure for the II and III groups of sensors.
7. Set the **“ОГНЕТУШ – ОТКЛ – КОНТР”** (Fire extinguisher WORK – OFF - CHECK) switch to the **“ОГНЕТУШ”** (Extinguishing) position.
8. Set the **“БАЛЛОНЫ”** (Extinguishers) switch to the **“АВТ”** (First extinguisher) position. During normal system operation, the «1» и «2» lights above the **“БАЛЛОНЫ”** selector should not illuminate.

### **Turn on the R-800L1 VHF radio**

Set the **“УКВ-2”** (VHF-2) switch on the right side panel to the up position. You can now communicate with the tower and wingmen.

### **Test the voice message unit (VMU)**

Press the **“ПРОВЕРКА – РЕЧЬ”** (ALMAZ check) button located near the top of the rear panel. The following message should be heard: “Voice warning system OK”.

### **Check area and set lights**

Upon receiving start-up clearance, make sure that the rotor area is free of people and foreign objects. In low visibility conditions, turn on the navigation lights and the rotor tip lights – **“КОД АНО”** (Navigation lights) are located on the overhead panel and the **“КОНТУРНЫЕ ОГНИ”** (Tip lights) switch is located in the rear portion of the right panel.

### **Turn on the fuel meter**

Set the **“ТОПЛИВОМЕР”** (Fuel meter power) switch, located on the right panel, to the up position.

Although optional, you may also consider creating or modifying ABRIS routes before APU and engine start.

### **Close the cockpit door**

## **APU Start-up**

Auxiliary Power Unit (APU) start-up procedure:

### **Open the APU fuel shut-off valve**

Set the **“ВСУ – ЗАКРЫТО”** APU fuel valve switch located in the fuel shutoff valve control panel to on. This switch is located on the wall panel. When set to on, the **“КРАН ВСУ ОТКРЫТ”** (APU valve open) green light should illuminate.



## Turn on forward and aft fuel tank boost pumps

Set the **"НАСОСЫ БАКОВ – ПЕРЕД"** (Forward fuel tank pumps) and **"НАСОСЫ БАКОВ – ЗАДН"** (Rear fuel tank pumps) switches to on. After doing so, the **"БАК ПЕРЕДНИЙ"** and **"БАК ЗАДНИЙ"** green lights on the overhead warning and indication panel (right side) should illuminate.

## Select engine start-up mode

Move the **"ЗАПУСК – ПРОКРУТКА – ЛОЖНЫЙ ЗАПУСК"** (Engine work mode) switch to the **"ЗАПУСК"** (start) position. The engine and APU start-up panel is located on the left side panel.

## Select Engine/APU

Move the **"ВСУ – ДВИГ ЛЕВ – ДВИГ ПРАВ – ТУРБОПРИВОД"** (Engine selector: APU-left engine-right engine-turbo gear) switch to the APU position (left).

## Start APU

Press the **"ЗАПУСК"** (Start-up selected engine/APU) button.

The APU will automatically reach stand-by mode, which is indicated by the illumination of the **"ВСУ ВКЛЮЧЕНА"** (APU on) light on the APU panel.

During the APU start-up cycle, monitor the following parameters:

- Exhaust gas temperature (EGT) of the APU is no more than 850 C°.
- Time elapsed until stand-by mode is reached (from start to "APU on" light illumination) is no more than 24 seconds.

Once the APU reaches stand-by mode, make sure that:

- The **"ВСУ ВКЛЮЧЕНА"** light on the APU panel is on.
- The EGT of the APU is no more than 720 C°.
- The green **"Р масла ВСУ"** (APU oil pressure normal) light illuminates.

APU warm up, with no air bleeding, should take one minute before using it for main engine starts.

## APU Start-up Troubleshooting

Cancel APU start up if:

- There is no EGT response after the start button has been pressed for 9 seconds.
- There are any anomalies in APU operation.
- There is an APU uncontrolled shut down.

The APU can be shut down by pressing the **"ОСТАНОВ ВСУ"** APU shutdown button.



In case of a start-up cancellation due to lack of the EGT increasing or an uncontrolled shut down, perform an engine crank before initiating another start-up.

The "AM-9B" (APU) will automatically shut down in case of RPM over-limit, which is indicated by the "ОСТАНОВ ВСУ по n" (APU off RPM max) light on the APU panel.

## APU Crank and False Start

A false start is used to check the APU system but without fuel ignition.

### APU false start procedure

1. Check the onboard or external electrical power supply.
2. Open the APU shut-off valve and turn on the rear fuel tank boost pump.
3. Move the engine start-up mode switch to the "ЛОЖНЫЙ ЗАПУСК" (false start) position.
4. Move the Engine/APU select switch to the "ВСУ" (APU) position.
5. Press the "ЗАПУСК" (Start) button.
6. After 15 seconds press the "ОСТАНОВ ВСУ" (Stop APU) button.

After a false start, you need to vent the remaining fuel from the combustion chamber and then do an engine crank. An APU crank serves to blow out any fuel in the APU combustion chamber after a failed start-up or false start.

### APU crank procedure

1. Check onboard or external electrical power supply.
2. Open the APU shut-off valve.
3. Turn on the rear fuel tank boost pump.
4. Move the engine start-up mode switch to the "ПРОКРУТКА" (crank) position.
5. Move the Engine/APU select switch to the "ВСУ" (APU) position.
6. Press the "ЗАПУСК" (Start) button.
7. After 15 seconds press the "ОСТАНОВ ВСУ" (Stop APU) button.

A false start and the crank should not exceed 15 seconds; therefore 15 seconds after pressing the Start button it will be necessary to press and release the "ОСТАНОВ ВСУ" (Stop APU) button to cut the fuel supply.

## Main Engines Start-up

Before starting the engines, the APU must be online.

### Engines startup procedure:

#### 1- Disengage rotor brake

Click on the brake lever and move it down to the **"РАСТОРМОЖЕНО"** (brake off) position.

## 2- Open the fuel shut-off valve to the selected engine

Select either the **"ДВИГ. ЛЕВ. – ЗАКРЫТО"** (left engine fuel shutoff valve switch) or the **"ДВИГ. ПРАВ. – ЗАКРЫТО"** (right engine fuel shutoff valve switch), depending on which engine you are starting. When you do so, either the amber **"КРАН ЛЕВ ЗАКРЫТ"** (left valve closed) or **"КРАН ПРАВ ЗАКРЫТ"** (right valve closed) light will extinguish.

## 3- Check operation of the forward and rear fuel tank boost pumps

Confirm that both the **"НАСОСЫ БАКОВ ЗАДН"** (aft fuel pump) switch and **"НАСОСЫ БАКОВ ПЕРЕД"** (forward fuel pump) switch are enabled and that the **"БАК ПЕРЕДНИЙ"** (forward tank) and **"БАК ЗАДНИЙ"** (rear tank) status lights are illuminated green.

## 4- Turn on the electronic engine governors

Located in the rear portion of the wall panel, set the **"ЭРД ЛЕВ"** (left engine governor) and the **"ЭРД ПРАВ"** (right engine governor) switches to on.

## 5- Select engine start-up mode

Check the position of the **"ЗАПУСК – ПРОКРУТКА – ЛОЖНЫЙ ЗАПУСК"** (engine start-up mode) and set the switch to the **"ЗАПУСК"** (start) position. The engine start-up switch is located on the left panel.

## 6- Select engine to start

Use the engine/APU switch to select the engine to be started on the **"ВСУ – ДВИГ ЛЕВ – ДВИГ ПРАВ – ТУРБОПРИВОД"** (engine selector: APU-left engine-right engine-turbo gear). The appropriate choices include **"ЛЕВ"** (left engine) or **"ПРАВ"** (right engine).

## 7- Start engine

Press the **"ЗАПУСК"** (Start-up selected engine) button.

## 8- Open cut-off valve lever of the selected engine

Once the engine RPM reaches 20%, move the appropriate red engine cutoff lever to the **"ОТКРЫТО"** (open) position, the engine will automatically reach idle mode in less than 60 seconds.

Upon reaching normal oil pressure in the engine gearbox, the green **"Р масла ПРИВОДОВ"** (gearbox oil press norm) light will illuminate.

CAUTION! It is forbidden to start the engines with no operating boost pumps.

During the engine startup cycle, monitor the following parameters:

- Smooth engine (gas-generator- GG) acceleration (lack of RPM "freezings").
- Increasing EGT.
- Rotors motion should initiate at GG RPM of no more than 25% (visual confirmation by looking at the nearest blade).



- Disengagement of the starter at GG RPM 60...65%. Monitor this with the **"КЛАПАН ЗАПУСКА"** (start valve) light going off (engines startup control panel on the left hand side panel).
- Hydraulic fluid pressure increases in all systems (auxiliary control panel).

After the first engine has been started, check the rotor's RPM at idle power.

Start the second engine by repeating the above procedure.

CAUTION! It is not advised to move the Engine/APU selector switch from one engine to another before the first engine has reached idle power. Rotor operation between 54...62% is not advised.

After both engines have been started, check the rotor RPM at Idle power, operation below 62% rotor RPM is not advised. If necessary to meet this requirement, move the engines' throttle levers up to attain a rotor speed of 62...70%.

After both engines have been started and are running normally, shut down the APU by pressing the **"ОСТАНОВ ВСУ"** (Stop APU) button and close the APU shut-off valve. The **"ВСУ ВКЛЮЧЕНА"** (APU on), **"КРАН ВСУ ОТКРЫТ"** (APU valve open), and **"и Р масла ВСУ"** (APU oil pressure normal) lights will go off.

Do not increase engine power past idle until the output oil temperature reaches +30 °C for the engines and no less than - 15°C for the main gearbox.

The throttle levers should only be moved to the **"АВТОМАТ"** (Auto) position after the engines have warmed up sufficiently.

## Main Engines Start-up Troubleshooting

Close the engine cutoff valve levers and press the **"СТОП ЗАПУСК"** (Interrupt start-up) button to cancel an engine start in the following situations:

- Rotor motion doesn't initiate at GG RPM 25%.
- There's no EGT or GG RPM increase (no ignition).
- EGT over-limit.
- GG RPM "freezing" for more than 3 seconds.
- The engine hasn't reached idle power 60 seconds after start-up initiation.
- Engine oil pressure at idle power is less than 2 kgf/cm<sup>2</sup>
- There's no hydraulic fluid pressure in the systems.
- The **"КЛАПАН ЗАПУСКА"** (start valve) light on the start-up panel hasn't gone off at GG RPM 66-67%.

Another start-up is allowed after an aborted start-up, only after reaching a full stop of the GG and addressing the reason(s) for the failed start-up. To attempt another start-up, attempt to do an engine crank first.



## Engine Crank and False Start

Doing a false start is used to check the functionality of the systems taking part in the start-up without the ignition process.

### Engine false start procedure

1. Engage the rotor brake.
2. Turn on the boost pump supplying the appropriate engine and open the shut-off and the cutoff valves.
3. Set the engine start-up mode switch to the **"ЛОЖНЫЙ ЗАПУСК"** (false start) position.
4. Set the APU/engine select switch to the Left or Right position, depending on engine to false start.
5. Press the **"ЗАПУСК"** (Start) button.

During the false start, monitor the following:

- The oil pressure should be no less than 0.5 kgf/cm<sup>2</sup>
- GG RPM should be no less than 20%

After the false start, it is necessary to do an engine crank.

The main engine crank procedure is analogous to the false start procedure but with the only difference being that the fuel cut-off valve is closed. Its purpose is to vent fuel from the combustion chamber.

### Engine crank procedure

1. Engage the rotor brake.
2. Open the fuel shut-off valve of the cranked engine and turn on the fuel tank boost pump supplying it. The cut-off valve lever must be closed (down position).
3. Move the engine start-up mode switch to the **"ПРОКРУТКА"** (crank) position.
4. Move the APU/engine selector switch to the Left or Right position, depending on which engine is being cranked.
5. Press the **"ЗАПУСК"** (Start) button.

During engine crank, monitor the following:

- Oil pressure should be no less than 0.5 kgf/cm<sup>2</sup>
- GG RPM should be no less than 20%

## Pre-flight Tests

After both engines have been started and are running normally at idle power, you can perform the following tests:

Check the operation of the anti-ice system of the engines and their dust protectors. Anti-ice test should only be performed when the ambient temperature is less than 5°C.

### Check engine anti-ice system

1. Move the collective to the full down position (minimum collective pitch).
2. Move the engines throttle levers to the **"АВТОМАТ"** (auto) position by pressing twice on the Page up key when in idle mode.
3. Set the **"ПОС ДВИГ – ОТКЛ – ПЗУ"** (engines anti-icing/dust protection systems) switch to the **"ПОС ДВИГ"** (engines anti-icing) position, on the overhead panel **"ПОС ЛЕВ ДВИГ"** (anti-ice left engine) and the **"ПОС ПРАВ ДВИГ"** (anti-ice right engine) lights should illuminate. The EGT should increase up to 60°C and GG RPM should increase up to 2%.
4. Turn off the anti-ice system switch (middle position) and the lights should go off.

### Check engine dust protectors

1. Set the **"ПОС ДВИГ – ОТКЛ – ПЗУ"** (engines anti-icing/dust protection systems) switch to the **"ПЗУ"** (engine dust protectors) position. The **"ПЗУ ЛЕВ ДВИГ"** (left engine dust protector) and **"ПЗУ ПРАВ ДВИГ"** (right engine dust protector) lights should illuminate. The EGT should increase up to 30°C and the GG RPM should increase up to 0.5%.
2. Turn off the dust protectors (middle position) and the lights should go off.

### Check rotors anti-ice system (AIS)

A rotor AIS test should be performed when the ambient temperature is less than 5°C.

1. Press the **"КОНТРОЛЬ СО"** (ice detector control) (top part of auxiliary control panel) button; after about 10 seconds, the **"ЛЕД"** (ice) light should illuminate.
2. Move the **"ПОС ВИНТОВ – ОТКЛ"** (rotors AIS - Off) switch on the overhead panel to the **"ПОС ВИНТОВ"** (AIS) and the **"ПОС ВИНТ"** (rotor AIS) light should illuminate. Make sure that after 30 to 50 seconds after releasing the **"КОНТРОЛЬ СО"** (ice detector control) button that the **"СО ИСПРАВЕН"** (ice detector OK) light illuminates, and after 55 to 100 seconds it should go off.
3. Move the **"ПОС ВИНТОВ – ОТКЛ"** (rotors AIS - Off) switch to the **"ОТКЛ"** (Off) position and the **"ПОС ВИНТ"** (rotor AIS) light should go off.

### GG and PT EEG tests

These functions allow you to test the operation of the GG channel of the EEG as follows:



- Raise the cover and set the **"КОНТР. ЭРД ТК"** (EEG GG Test) switch to the **"ТК"** (GG) position.
- Move the throttle lever of the tested engine to the upper limit (max).
- Increase the collective pitch until the rotor RPM drops to 86...87%, on the overhead panel the **"ОГРАН РЕЖ ЛЕВ"** (LEFT ENG PWR LIMIT) or **"ОГРАН РЕЖ ПРАВ"** (RIGHT ENG PWR LIMIT) yellow lights will illuminate.
- The GG RPM should be set at 4% below the estimated maximum value.

Set the **"КОНТРОЛЬ ЭРД ТК"** (EEG GG Test) switch to the operation position (down) and close the cover and the LEFT ENG PWR LIMIT or RIGHT ENG PWR LIMIT yellow lights should go off.

Caution! Do not increase the engine's power above lift-off value.

Test the PT contour of the EEG as follows:

- Set the throttle levers to the IDLE position.
- Open the cover and set the **"КОНТР. ЭРД СТ-1 – РАБОТА – СТ-2"** (EEG PT-1 Test – Operate – EEG PT-2 Test) switch and select the **"СТ-1"** (PT-1) position.
- Slowly move the throttle levers from the IDLE position until the **"n ст ПЕРЕД ЛЕВ ДВИГ"** (LEFT ENG PT OVRSPD) and **"n ст ПЕРЕД ПРАВ ДВИГ"** (RIGHT ENG PT OVRSPD) lights illuminate. This should occur at rotor RPM around 86%. Simultaneously, a **"Раскрутка турбины левого двигателя"** (Left engine power turbine over-speed) and **"Раскрутка турбины правого двигателя"** (Right engine power turbine over-speed) voice message will be heard.
- Use the throttle levers to decrease rotor RPM by 5...7%, and the light should still be illuminated.
- Set the **"КОНТР. ЭРД СТ-1 – РАБОТА – СТ-2"** (EEG PT-1 Test – Operate – EEG PT-2 Test) switch to the middle **"РАБОТА"** (Operation) position and the light should go off.
- Move the throttle levers back to IDLE.
- Set the **"КОНТР. ЭРД СТ-1 – РАБОТА – СТ-2"** (EEG PT-1 Test – Operate – EEG PT-2 Test) switch to the **"СТ-2"** (PT-2) position and repeat the procedure described above.

After this test, set the **"КОНТР. ЭРД СТ-1 – РАБОТА – СТ-2"** (EEG PT-1 Test – Operate – EEG PT-2 Test) switch to the middle **"РАБОТА"** (Operation) position and close the switch cover.

**"РТ-12-6 ЛЕВ"** and **"РТ-12-6 ПРАВ"** buttons decrease the control threshold of the EGT governors to check the serviceability of the EEG. When either of these buttons is pressed, the GG contour of the EEG disengages. If the EGT is no less than 850°C and GG RPM is no less than 87%, the EGT decreases by 30°C or more and the GG RPM decreases by 84% of the maximum value.



## Rotor RPM readjustment check

1. Check the rotor RPM readjustment range with collective stick full down and both throttle levers in the Auto position. Move the readjustment selector on the collective stick handle from the **"НОМИНАЛ"** (nominal) position to the **"НИЗК"** (low) position. Make sure that afterwards the rotor RPM decreases at about 5% and the "zebra" light starts flashing.
2. After the test, move the rotor readjustment selector to the nominal position. Thus, the rotor RPM should increase to the nominal value and the "zebra" flashing light should go off.

## Check flight controls and the hydraulic systems

1. Move the cyclic in both axis, press the rudder pedals and lift the collective (no more than 1/3 of the range) one at a time and make sure that flight controls are working properly.
2. On the hydraulic systems pressure indicators (located on the rear panel), make sure that flight controls operate within 65...80 kgf/cm<sup>2</sup> during flight.
3. Turn off the main hydraulic system (wall panel) by moving the **"ОСН. ГИДРО ОТКЛ"** (hydr. syst. main off) switch to the **"КОНТР"** (main off) up position. The master warning light (MWL) will start flashing and the **"КЛАПАН I ГИДРО"** (hydraulic valve 1) and **"КЛАПАН II ГИДРО"** (hydraulic valve 2) lights will illuminate. On the EKRAN display, the message **"ОСНОВНАЯ ГИДРО"** (main hydraulic system) will be shown.
4. Move the **"ОСН. ГИДРО ОТКЛ"** (hydr. sys. main off) switch to the **"Р/С"** (off) down position and all lights should go off.
5. Check the pressure in the emergency hydraulic accumulator on the auxiliary control panel and this should be the same as in the main hydraulic system.

## Final electrical power setup

1. With the throttle levers in the Auto position, turn the AC left and right generator switches to on (right hand side panel): **"ТОК ГЕН. ПРАВ"** Right generator switch and **"ТОК ГЕН. ЛЕВ"** Left generator switch.

This check list is mandatory to avoid AC power loss to the **"ИКВ"** (inertial navigation system INS).

2. Disconnect ground power unit (GPU) by setting **"=ТОК АЭР ПИТ "** and **"~ТОК АЭР ПИТ "** to off (down). With communication to the ground crew select: Maintenance >Ground Elec Power >to Off (the ground crew must retract the power cord).
3. Move the **"ПРЕОБР АВТ – ОТКЛ – РУЧН"** (AC/DC inverters: auto-off-manual) switch to the **"АВТ"** (auto) up position, and the **"ПРЕОБРАЗ"** (inverter) light should go off.

## Final Checks

After performing the above pre-flight checks, you may wish to configure secondary systems before lifting off. You may find it easier to configure these systems on the ground rather than in flight. The below check lists do not have to be performed in this exact order.

### Wall panel

1. Turn on the navigation and targeting system switch "**ПНК ВКЛ – ОТКЛ**"
2. Set PVI-800 navigation control mode and settings as needed
3. Enable data link power "**ВЦУ - ОТКЛ**"
4. Adjust PVI-800 brightness
5. Select PVTs-800 ownship data link ID "**КТО Я**"
6. Select PVTs-800 data link send/receive mode "**РЕЖИМ**"
7. Select autopilot flight modes
8. Select autopilot altitude hold mode
9. Select autopilot heading/course mode
10. Turn on "**УКВ-2**" switch to provide power to R-800L1 radio ("**УКВ-1**" should already be on)
11. Turn on "**ТЛК**" switch for data link power
12. Turn on "**УКВ-ТЛК**" switch for data link communication
13. Run self-test on ARK-22 ADF
14. Set ARK-22 compass channel if needed
15. Set R-828 radio channel
16. Set automatic tuner function for set R-828 channel
17. Enable power to signal flare panel
18. Enable power to the weapon control system "**СУО – ОТКЛЮЧЕНО**" switch
19. Turn on pilot ejection control (3 switches)
20. Enable lighting to the back-up ADI if needed
21. Turn on anti-collision light if needed



22. Turn on rotor tip lights if needed
23. Turn on formation lights if needed
24. Turn on HSI and ADI lighting if needed
25. Turn on NVG cockpit lighting if needed
26. Turn on cockpit lighting for labels if needed

Note that you can adjust cockpit lighting brightness by using the lighting brightness control panel at the bottom of the auxiliary panel

### **Left and Right Forward panels**

1. Reset/adjust clock/stop watch as needed
2. Turn on ABRIS and configure as needed
3. Test ADI and calibrate if needed
4. Adjust HSI heading and flight path if HSI set to manual control
5. Set floor on barometric altimeter
6. Test radar altimeter (check ABRIS altitude sensor reading)
7. Reset accelerometer (g-meter) if needed
8. Re-cage backup ADI if needed
9. Test fuel quantity gauge

### **Rear panel**

1. Turn on INU power
2. Turn on "Л-140 – ОТКЛ" laser warning system power
3. Perform "Л-140 КОНТП" LWS self-test
4. Turn on "УБ-26 ВКЛ – ОТКЛ" Countermeasure system power
5. Perform "УБ-26 КОНТП – ОТКЛ" CMS self-test
6. Check that hydraulic value lights 1 and 2 are lit

### **Overhead panel**

1. Pitot static port heat switch to on



2. Pitot ram air heat switch to on
3. Configure UV-26 countermeasure panel as desired
4. Reset laser warning system panel if needed

### **Center panel**

1. Select cannon round type (armor piercing or high explosive)
2. Select burst length (short, medium, or long)
3. Select manual or auto weapon control mode
4. Select rate of fire (low or high)
5. Adjust HMS/NVG brightness (first enable HMS/NVG from left panel)
6. Select Shkval symbology polarity
7. Select HUD declutter on or off
8. Select Shkval laser designation code
9. Adjust Shkval display brightness
10. Adjust Shkval display contrast
11. Select main landing light or back up landing light
12. Turn on landing light if needed
13. Set ADF beacon mode switch as needed (near, distant, or auto)

### **Left panel**

1. Run R-800L1 radio self-test
2. Select R-800L1 AM or FM band
3. Select R-800L1 guard frequency if needed
4. Select R-800L1 ADF mode if needed
5. Set R-800L1 radio frequency
6. Select training or combat mode **"ТРЕНАЖ – ОТКЛ"**
7. Enable power to the K-041 targeting system **"K-041 – ОТКЛ"**
8. Enable power to the helmet mounted sight if needed **"ОБЗ – ОТКЛ"**



9. Select weapon firing mode
10. Set laser to standby **"ИЗЛ. – ОТКЛ"**
11. Select manual or automatic "Shkval" targeting mode **"АС-ПМ"**
12. Set SPU-9 intercom accordingly (R-828, R-800L1, ADF, or ground crew)





**6**

**FLIGHT  
SCHOOL.**



## 6 FLIGHT SCHOOL

### GENERAL REQUIREMENTS

The following ground school sections are here to provide you with the requirements and our recommendations for flying the Ka-50. Ground school will cover each phase of a sortie, from taxi prep to engine shut down, and it assumes that all helicopter systems are working properly. Particular attention is paid to the description of acceptable flight parameters and the results of exceeding them.

It is recommended that the helicopter always be flown with the autopilot (AP) modes engaged; this provides much greater stability in all flight regimes. Nevertheless, flights can be performed without AP in case of systems failure or training purposes. The Ka-50 is still quite controllable without AP assists.

The primary way to fly the helicopter is by using instrument flying with reference to the attitude direction indicator (ADI) and the head-up display (HUD) indication.

Flight level changes should be made by using the collective while maintaining a constant pitch angle (on the ADI or HUD). To change airspeed, set the cyclic to match the desired airspeed (forward to increase speed and back to decrease speed).

### TAXI PREPARATION AND TAXI

Check the instruments for any indications that engines, rotor system, helicopter systems or components are not working properly. Make sure that there are no emergency indications on the warning lights panel and EKCRAN display. All warning systems should indicate normal operations.

When taking off from an airfield, request engine start-up, hover test, and taxi clearance from the ground traffic controller.

Engage the autopilot channels:

- **K** – Bank hold
- **T** – Pitch hold
- **H** – Heading/course hold

Engage the ejection system switches by first raising their safe cover (yellow-black zebra) and then turning on the three switches “**АВАР ПОКИДАН**” (emergency ejection).

Uncage Standby Attitude Indicator (SAI) by rotating the SAI knob counterclockwise while holding down the right mouse button on the knob.

## Taxi Initiation

Taxi procedure:

1. Request taxi permission from control tower.
2. Make sure that there are no obstacles or foreign objects in the taxi path of the helicopter.
3. Disengage the parking brake.
4. Smoothly increase the collective pitch by  $\frac{1}{4}$  of its range and gradually move the cyclic stick forward to start moving.

Using the ground as reference, control taxi speed with the cyclic, collective, and wheel brakes. You can also use the anti-torque pedals to turn the facing of the helicopter. Taxi should be performed on hard, smooth surfaces at speeds up to 15km/h with a wind speed less than 20m/s.

To halt the helicopter during a taxi, you should move the cyclic to a neutral position, decrease the collective pitch, and engage the wheels brakes. In case of brake failure, you can halt the aircraft by pulling the cyclic back while increasing collective pitch to nearly hover. The helicopter must be carefully controlled with the cyclic to avoid the tail hitting the ground.

In case of low visibility conditions, turn on the blade tip lights, the navigation lights, and the anti-collision light. You can also turn on the main or backup landing lights and manually direct the main light.

## Taxi

Taxi turns are executed with smooth and simultaneous input of the anti-torque pedals and cyclic stick towards the direction of the turn. Be careful to avoid a banking angle over  $5^\circ$  and high speed turns.

**CAUTION!** Backward taxi and turns on one wheel are not advised.

During taxi in a crosswind, the helicopter will have a tendency to turn toward the wind. This should be compensated for by reacting with a neutral bank angle towards the wind direction up to  $5^\circ$ .

Taxi on soil or snow should be performed with extreme caution and at speeds up to 5 km/h or less. Nose wheel bounce should be avoided by controlling the helicopter via the cyclic and collective sticks.

## TAKEOFF AND CLIMB

There are two takeoff methods:

- Helicopter style takeoff – no forward speed with vertical lift-off and forward speed gained only after hover.
- Airplane style takeoff – forward acceleration on the ground to achieve lift-off speed.

Your choice of either of these two methods should be based on the takeoff airfield (dimensions, condition, and elevation), weather conditions, and payload. By default, airplane-style takeoffs should be performed against the wind.

Before takeoff, check the operation of the power plant, control systems, center of gravity balance, and whether it is possible to generate enough vertical lift in the given atmospheric conditions to provide a hover check at 2 to 10m.

### Hover Check

Vertical takeoff and hover procedure:

1. Orient the helicopter to face against the wind and taxi for 2-3m to align the wheels.
2. Engage the parking brake.
3. Check the pitch angle.
4. Make sure the flight instrument indications are within normal limits.
5. Evaluate the takeoff area space and request hover check permission from the control tower.
6. Upon receiving clearance, release the wheel brakes, smoothly pull up the collective stick, and set the desired hover altitude. Be careful not to let the aircraft bank or yaw.
7. Trim the helicopter by pressing the trim button. **If you don't have a Force Feedback joystick, after pressing the trim button you must move the stick to the neutral position.**
8. Maintain the required altitude with smooth movements of the collective. Use the radar altimeter and visual ground references to hold a constant altitude in the hover. Hover turns should be executed with smooth pedal inputs towards the turn (left turn-left pedal), and the pilot should avoid any forward or lateral cyclic control inputs.
9. It may help to leave the cockpit door open to provide a better ground visual reference.

In hover mode, the helicopter has positive feather stability and it tends to turn against the wind (weather cocking). Therefore, when making a turn with full pedal input, it



should be understood that during the first half of the turn that the turn rate is slow and that it will be much faster in the second part, depending on the wind speed.

During a hover check, the following checks are performed:

- Aircraft control. When moving the controls, the helicopter executes the required maneuvers with enough control reserve range in all channels.
- Center of gravity (CG) position - according to the cyclic stick (joystick) position after balancing the helicopter in a hover. In the middle CG position, the cyclic stick must be centered and the trims must be cancelled.
- Hover mode stabilization. At an altitude of at least 4m, balance the helicopter, trim the helicopter, and engage the Hover mode by pressing the Hover button. After doing so, the "ВИСЕНИЕ" (hover) light will illuminate. On the HSI, the needles become perpendicular to each other and their deflection corresponds to the helicopter's hover position. After the check, turn off this mode. A neutral (zero) position should be indicated on the pitch scale on the "ИКП".
- The vertical lift-off ability of a helicopter is heavily dependent on atmospheric conditions.

If during a hover check the helicopter is unable to reach the required hover altitude, it is best to land and decrease the takeoff weight (TOW).

## Vertical Takeoff Using the Rotor-In-Ground Effect

You may perform such a takeoff when the helicopter is in a stable hover at an altitude of no more than 2 meters. The engines will need to be at maximum power.

Takeoff procedure:

1. Establish a hover check 2 to 3 meters above the ground.
2. Request takeoff permission from the control tower.
3. Make sure all flight instrument indications are within acceptable limits and descend to 1m.
4. Smoothly push the cyclic forward and initiate forward flight acceleration while increasing engine power to takeoff mode (in case spare power is available). This is in order to prevent any sinkage of the helicopter.
5. Forward flight acceleration should take place in the rotor-in-ground zone with a gradual climb to 5 m altitude at 90 to 100km/h IAS.
6. Further acceleration should be performed with a slight climb.

## Vertical Takeoff without Using the Rotor-In-Ground Effect

You can perform such a takeoff when the helicopter is in a stable hover at no less than 10 m above obstacle height in the takeoff direction. Maximum engine power would be used.

Takeoff procedure:

1. Establish a hover check at no less than 10 m.
2. Request takeoff permission from the control tower.
3. Make sure all flight instrument indications are within acceptable limits and that the altitude is enough for a helicopter style takeoff.
4. Smoothly push the cyclic stick forward and initiate forward flight acceleration while increasing engine power in order to prevent any sinkage of the helicopter.

If the collective input for takeoff power is not enough to compensate for the sinking (descent) of the helicopter, it will be necessary to pull back on the cyclic to increase the pitch angle and decrease both the acceleration rate and sink rate.

## Running Takeoff

You can perform such a takeoff when the helicopter is in a stable hover at an altitude no less than 1m. Engines will need to be at takeoff power and the field conditions need to permit operations in the rotor-in-ground zone.

Takeoff procedure:

1. Perform a hover check.
2. After the hover, land smoothly.
3. Request takeoff permission from the control tower.
4. Smoothly push the cyclic stick forward and initiate forward acceleration while increasing engine power to takeoff mode. Accelerate with the maximum possible rate (pitch angle no more than  $-10^{\circ}$ ). The main landing gear wheels will lift-off the ground.
5. At an IAS of 30 to 40 km/h, with negligible pull on the cyclic, lift the helicopter off.
6. Once airborne, accelerate with a gradual climb up to 100 to 120 km/h and then continue the climb at this airspeed.

## Takeoff Peculiarities

During a crosswind takeoff, deflect the cyclic in the direction against the wind; this will compensate the drift in the lift-off moment. Simultaneously, apply pedal input to prevent the wind's yaw momentum. The required controls deflection depends on wind speed.

During takeoff and landing on dusty or snowy fields, the helicopter creates dust/snow vortices that impact visibility. Takeoff and landing in dusty conditions should be performed with the Engines' Dust Protectors (EDP) on. Prior to takeoff it is recommended to blow off the dust from the field with the rotors' wash.

## Climb

Climb is implemented according to the established flight pattern of the particular airfield.



After takeoff and transition to climb, set the required flight regime, trim the controls, and proceed to the given waypoint or departure route.

During a climb, maintain maximum continuous engine power and maximum range cruise speed. If necessary, apply takeoff power or a regime lower than the maximum continuous setting.

During a flight, do not allow rotor RPM to drop below the minimum level. At 85% rotor RPM, the rotor's RPM "zebra" warning light starts flashing.

Upon reaching the required altitude, level off, set the required IAS by setting the pitch angle with the cyclic, and with the collective, set the engine regime corresponding to the required IAS. Trim the controls and engage the altitude stabilization mode.

## HORIZONTAL FLIGHT AND TRANSITIONS

Recommended IAS in the traffic pattern is 160 to 200 km/h.

Barometric altitude stabilization is advised in horizontal flight at altitudes greater than 50 m. To change the flight level by more than 100 m, the altitude on the autopilot control panel and the stabilization mode should be disengaged by pressing the "B" push-light. After reaching the required altitude, re-engage the mode and the push-light will illuminate.

### Visual Flight Rules (VFR) Traffic Pattern

The VFR traffic pattern is implemented at the altitudes and IAS according to the flight operations manual of the particular airfield (helipad). On airfields without radio navigation equipment, use ground landmarks for reference and time estimation using the track needle when the HSI is in the manual mode ("ЗПУ" (track angle) selector in the "ПУЧ" (manual) position).

After takeoff and reaching an altitude of 40m, with an airspeed of 120km/h IAS, make sure that the power plant and aircraft systems are operating normally; then retract the landing gear.

During the climb-out, maintain 120 to 140 km/h IAS and a 3 to 5 m/s vertical speed. Maintain the runway heading, and upon reaching a 100 to 150m altitude, turn to the crosswind leg 90° left (right). At a pattern altitude and airspeed of 160 km/h IAS, level off and trim the controls.

After level flight is established, turn to the downwind leg, heading opposite to the takeoff runway direction.

Turn the base leg in level flight at 120 to 140 km/h IAS, extend the landing gear, and request landing clearance from the control tower.

Upon turning on the base leg, maintain 120 to 140 km/h IAS and start descending with a vertical speed of 3 to 4 m/s. Complete the final turn of the leg at no less than 100 m.

During the approach, estimate the vertical speed to ensure the estimated touchdown point (ETP). When using the helicopter style of landing (most used), the ETP should be determined 50 to 100 m before touchdown.

At 400 to 500 m from the ETP and 50 to 70 m altitude, start to smoothly decrease the airspeed.

Before landing, double-check that the landing gear is extended.

### Transitional Flight Regimes

The barometric altitude hold mode can be engaged when radar altitude is above 50 m. To change your altitude when in altitude hold mode, press the collective brake lever; to retain it for the duration of the transition maneuver, release the brake lever. After this, a new altitude hold altitude will be set.





- To initiate a hover during vertical climb, smoothly lower the collective to cease the climb. Any altitude deviation should be corrected with small collective inputs.
- To initiate a manual, vertical descent from a hover, decrease the collective so that the descent rate is no greater than 3 m/s at altitudes above 10 m but greater than 3m/s. If it is too high, you risk a vortex ring entry.
- To initiate forward flight from a hover, push the cyclic forward and set a pitch angle corresponding to the desired acceleration rate. Simultaneously, maintain the altitude by collective inputs. Upon reaching the desired speed, set a pitch angle corresponding to this speed.
- To increase forward airspeed, smoothly move the cyclic forward while simultaneously increasing the collective pitch to maintain altitude. If takeoff power is applied (rotor RPM drop and engagement of the “zebra”) to maintain altitude, it will be necessary to decrease the acceleration rate by pulling the cyclic back and decreasing the collective until the rotor’s RPM recover to the desired value. Avoid any bank, pitch and yaw tendencies by compensating with appropriate cyclic and rudder inputs.
- To reduce airspeed in horizontal flight, smoothly pull back on the cyclic to set the desired deceleration pitch angle. Hold the current altitude with collective input.
- To transition from forward flight to a hover at the same altitude, pull back on the cyclic to set the desired pitch angle and slow the helicopter down with the desired rate. Compensate any climb tendency by applying the corresponding collective input. Yaw and roll should be compensated for with the cyclic and pedals.
- To descend during horizontal flight, smoothly move the collective down until the desired vertical speed is reached. Maintain the pitch angle with the cyclic and make sure that the airspeed is constant.
- To level off the helicopter into horizontal flight after a descent, smoothly increase the collective, and using the vertical speed as a reference, stabilize the helicopter in horizontal flight.
- To transition from a descent to a hover, pull back on the cyclic to set the desired pitch angle and start decelerating. Decrease the vertical speed (sink rate) smoothly by increasing the collective until the helicopter is in a hover mode. Use the cyclic to eliminate any forward speed of the helicopter and balance it in a hover.
- To level off the helicopter after a climb, set the desired pitch angle with the cyclic to ensure the desired IAS and maintain the desired altitude with the collective.
- To transition to a climb from horizontal flight, smoothly increase the collective while simultaneously maintaining a constant pitch angle.

In all transition regimes, the collective and cyclic inputs should be done with such rates and magnitude that it will ensure rotor RPMs are within operating limits.



All forces on the controls during transition modes will be cancelled by the trim mechanisms. Any deviation in pitch, bank, and yaw should be compensated for by an appropriate input of the cyclic and the pedals.

## DESCENT

The following descent regimes can be used:

- Descent with operating engines and forward speed
- Vertical descent with operating engines
- Autorotation

Descent with operating engines and forward speed on a flat trajectory is the most common type of descent. Before the approach, request landing permission from the control tower and set the airfield barometric pressure for the airfield.

At an IAS below 50 km/h, do not exceed a sink rate of 5 m/s to avoid entering into a "vortex ring" state.

### Descent with Operating Engines and Forward Speed

Descent procedure:

1. Set a pitch angle to correspond with the desired IAS (no less than 70 km/h). The recommended forward speed is 120 to 140 km/h.
2. Set the collective to correspond to the desired vertical speed; do not allow rotor RPM over-speed. Rotor RPM over-speed up to 91 to 98% is allowed for up to 20 seconds.
3. At the desired altitude, level off the helicopter into horizontal flight.

### Vertical Descent with Operating Engines

This type of descent is suggested with a vertical descent:

- At altitudes below 10 m - anytime.
- At altitudes between 200 m to 10 m when a descent with forward speed is not possible or during combat.

A vertical descent should be performed with vertical speed of no more than 3 m/s. Close to the ground, vertical descents should be performed against the wind if possible and avoid lateral movement and yaw turns at touchdown.

Vertical descent procedure:

1. Hover at the desired altitude.
2. Smoothly decrease the collective while estimating the vertical speed to be no more than 3 m/s.
3. In case the vertical speed increases above 3 m/s, smoothly increase the collective to avoid entering a "vortex ring".

4. In case the vertical speed unintentionally increases above 5 m/s, move the cyclic forward and slightly decrease collective in order to move the helicopter into forward flight.
5. If vertically descending from an altitude of 10 m, smoothly increase the collective, decreasing the vertical speed and smoothly land the helicopter.

Use ground references during a descent to avoid any lateral movement at touchdown.

## Descent in Autorotation

Descents in regimes close to autorotation are implemented at the engines' minimum power settings in the following cases:

- For training purposes to simulate both engines failing in flight.
- When extreme rate-of-descent is required. The maximum vertical speed, depending on the weight and the IAS, is 13 to 16 m/s. Minimum vertical speed is achieved at a forward speed of 130 km/h.

Descent using autorotation procedure:

1. During horizontal flight, set the IAS that will be used for the descent, balance the helicopter, and trim the controls.
2. Zero-out collective input but do not allow rotor over-speed.
3. Move the throttle levers to the idle power position, recheck the rotor RPM, and correct it with the collective stick. The rotor RPM during the steady descent should be within 86 to 90%. Any turns should be performed with bank angles up to 30°.
4. At a safe altitude, move the engines throttle levers to the Auto position and start pulling the helicopter out of the descent while maintaining a rotor RPM within 86 to 90%.

**CAUTION!** The efficiency of yaw control decreases at small collective pitch and high rotor RPM; therefore, slowing down below 100 km/h forward speed during autorotation is not advised. The decreased pedal yaw control is partially compensated by the corresponding slip set by the cyclic

To perform a descent with a high vertical speed (in emergency) after readjustment in flight of the rotor RPM from the rated (89%) to the low (84%):

1. Set the descent IAS while in horizontal flight.
2. The minimum IAS should be no less than 70 km/h; the maximum should be no more than 200 km/h. The recommended IAS is 120 to 140 km/h.
3. Change the maintained rotor RPM from rated to low when in horizontal flight by moving the **“ОБОРОТЫ НОМИНАЛ – НИЗК”** (RPM rated-low) readjustment switch on the collective handle from the **“НОМИНАЛ”** (rated) to the **“НИЗК”** (low) position. The maintained rotor RPM should decrease to 84% and the “zebra” warning light should illuminate.



4. Decrease the collective to the minimum. What follows will be an intensive increase of vertical speed, which depending on aircraft weight, IAS, and altitude, could be within 15 to 18 m/s. The rotor RPM in the descent increases slightly to 85 to 86%. At an altitude above 1000 m, correct the rotor RPM with the collective and do not allow it to exceed 86%. In case of MWL and emergency light ( $V_{\text{max доп}}$ )- ( $V_{\text{max}}$ ) illumination, which could occur at high altitude, decrease the IAS. To perform a descent with an even higher sink rate, it is necessary to enter into a spiral with the bank within 30 degree limits. The vertical speed in this case can reach 25 to 35 m/s. Pull the helicopter up from the descent by estimating the altitude needed to decrease and eliminate the vertical speed.
5. Level off the helicopter in horizontal flight. Set the rated rotor RPM by moving the **“ОБОРОТЫ НОМИНАЛ – НИЗК”** (RPM rated-low) switch on the collective handle from the **“НИЗК”** (low) to the **“НОМИНАЛ”** (rated) position while simultaneously increasing the collective pitch to minimize the time needed for the rotor to reach 89%. The “zebra” warning light should go off after that.

## LANDING IN CLEAR METEOROLOGICAL CONDITIONS

Landing is performed using one of the following methods:

- Helicopter style – landing from a hover with no roll-out.
- Airplane style - landing touchdown with forward speed and ground roll out.

The type of landing is generally chosen according to the landing area (dimensions, condition, and elevation), meteorological conditions, and weight of the helicopter. The landing should take place, if possible, against the wind.

### Vertical Landing Using the Rotor-In-Ground Effect

This landing method is essential. The hover is implemented in the rotor-in-ground effect zone.

Landing procedure:

1. On a short final (after passing over the inner NDB), start the approach at 70 m and smoothly pull back on the cyclic to set the corresponding pitch angle to decelerate. Estimate that at 20 to 30 m altitude, the forward speed is 40 to 50 km/h.
2. Further decrease the forward and vertical speeds and estimate the desired point that the helicopter should hover at an altitude of 2 to 3 m.
3. By decreasing the collective smoothly, land the helicopter while avoiding lateral movement.
4. After making sure that the helicopter is stable on the ground, fully lower the collective.

### Vertical Landing Without Using the Rotor-In-Ground Effect

This method is generally used to land at an airfield with limited dimensions, obstacles, or snowy / dusty conditions. The hover is implemented out of the rotor-in-ground effect zone.

Landing procedure:

1. On a short final (after passing over the inner NDB) with an altitude of 70 m, smoothly pull back on the cyclic and set the corresponding pitch angle to decelerate in relation to the estimated landing point. Ensure a safe altitude of at least 10 m above obstacles.
2. Prior to reaching the airfield, or being above it, decelerate to 40 to 50 km/ and do not allow the vertical speed to exceed 2 m/s.

3. Visually control the altitude and the vertical speed from 20 to 30 m and below by using clearly visible ground objects that can serve as altitude references.
4. Hover above the landing area at an altitude at least 5 m above obstacles.
5. After establishing a hover, perform a smooth descent and landing while avoiding any lateral movement.
6. After making sure the helicopter is stable on the ground, fully lower the collective.

## Roll-out Style Landing

This landing is used if it is impossible to perform a hover due to lack of engine power (high mountain fields or high ambient temperatures). The landing is performed on an airfield or on a tested field with available approaches.

Landing procedure:

1. On a short final (after passing over the inner NDB), start at 70 m and smoothly pull back on the cyclic to set the corresponding pitch angle to decelerate. You can estimate that at 20 to 30 m altitude the forward speed is 60 to 70 km/h.
2. Continue the descent and decrease forward airspeed such that at touch down the forward speed will be 30 to 40 km/h.
3. Smoothly land the helicopter on the main wheels and then allow the nose wheel to drop down by lowering the collective further.
4. To decrease the roll out length, the rotors should be used for deceleration by smoothly pulling back on the cyclic stick. Also apply wheel brakes when the speed is below 40 km/h.

## Landing Peculiarities

The approach should be implemented with forward and vertical speed ensuring operation out of the dust vortex zone.

After deciding on an airfield to land at, you must evaluate the situation and plan the approach and landing based on several factors: particular field conditions, the size and the condition of the field, its elevation above sea level, obstacles in the approach course, and the wind direction and speed.

## ENGINES AND EQUIPMENT SHUT DOWN

Normal shut down procedure:

1. Move the cyclic and the pedals to their neutral position and move the collective fully down.
2. Turn off ABRIS.
3. Turn targeting and navigation systems, switch K-041, off.
4. Turn off generators. Check that the "ΠΡΕΟΒΡΑΣ" (Inverter) lamp on the overhead panel is lit.
5. Move the engine throttle levers to the idle position.
6. Turn off all electrically-powered systems except for power plant parameter indicators.
7. Shut down the engines by moving the cut off valve levers to the closed position.
8. Engage the rotor brake when rotor RPM is less than 30%.
9. After the engines fully spool down, close the engine fuel shut-off valves.
  
10. Turn off the fuel boost pumps.
11. Cage SAI by pulling the SAI knob and turning it clockwise.
12. Turn off all switches.
13. Turn off the batteries.



## ROUTE, DESCENT AND HOVER MODES

In this chapter we will discuss the use of a flight route via the PVI-800 navigation control panel. This assumes that a flight route has first been created in the Mission Editor (ME). Keep in mind that the PVI-800 flight and navigation system can only operate with up to six pre-loaded waypoints (WP) from the ME or created when in the cockpit. Therefore, when using the autopilot route mode, you should consider this limit when placing WPs in the ME for the mission. Routes created in the ABRIS cannot be used by the PVI-800 navigation system for automatic route flight. The PVI-800 and ABRIS navigation systems are not linked!

During pre-flight, perform a test of the navigation system prior to take off:

- Set altimeter pointers to zero.
- Set the minimum safe altitude.
- Check that the heading indication on the HSI and magnetic compass are in relation to the takeoff (runway) heading.
- Check that the selected NDB radio bearing RMI needle is correct on the HSI.
- Check that the Mode selector switch on the PVI-800 Navigation Control panel is in the **"РАБ"** (Operation) position. Press the **"ППМ"** (Waypoint) push-light and then the desired WP number on the keypad.
- Check that the **"ЗПУ-ЗК АВТ – РУЧН"** (Desired Track Angle-Desired Heading, Auto - Manual) switch next to the HSI is in the **"АВТ"** (Auto) position.
- Check that the **"ЗК-ЛЗП"** (Desired heading - Desired track) switch on the Autopilot panel is in the correct position according to desired hold, heading, or course hold, as task requires.
- Check that the helicopter's position on the ABRIS is at the initial point and the heading is to the first WP.
- Start the flight time Clock.

### Pre-loaded Route Autopilot Flight

Prior to loading a flight route:

- From the INU heading data selector switch on the right panel, set the switch to the middle **"ГПК"** (Directional Gyro) position.
- From the **"ЗПУ-ЗК АВТ – РУЧН"** (Desired track angle - Desired heading, Auto - Manual) switch next to the HSI, set the switch to the **"АВТ"** (Auto) position.

After takeoff, stabilization, speed, heading, and trimming, engage the Route Flight mode by setting the **"МАРШРУТ-СНИЖЕН"** (Route - Descent) switch on the collective to the **"МАРШРУТ"** (Route) position. This in turn will engage **"МАРШРУТ ЗК (МАРШРУТ**



**ЛЗП**) (Route DH (Route DT) and the helicopter will automatically initiate a turn to the first waypoint with a bank angle up to 15°.

According to the selected **ЗК-ЛЗП** (Desired Heading - Desired Track) switch position on the Autopilot panel, the helicopter will automatically turn toward the WP from either its current location (fly directly to steerpoint) or to intercept and stabilize on the desired course track.

Once you have climbed to the desired altitude, set the altitude stabilization selector **БАР-РВ** (BARO/RALT altitude hold modes) switch on the Autopilot panel to the desired position according to task. Ensure that the Altitude Hold autopilot channel is engaged (blue push-light with "B" in the center).

When the RALT hold sub-mode is on, the HUD altitude scale and a numeric are visible when below 50 m. When BARO hold sub-mode is selected, a barometric altitude numeric is indicated on the HUD.

When approaching the next WP in DT mode, a linear lead turn is estimated in such a way that prior to reaching the WP an automatic turn is initiated to intercept the next track of the route. In DH mode on the other hand, the turn begins when the WP is passed. In both DT and DH modes, the **ППМ РАЗВОРОТ** (Turn to the next waypoint) light will illuminate a hundred meters prior to turn initiation. The automatic turn is then initiated toward the next WP with bank angle no more than 15°. When the turn is initiated, the current navigation route data is replaced by the data of the next track in the route. 5° prior to reaching the new heading, the **ППМ РАЗВОРОТ** (Turn to the next waypoint) light goes off and the heading is automatically corrected in accordance to the current location of the helicopter at the end of the turn and drift angle.

The procedure during the other tracks of the route is the same.

250 m before the last WP, the **КОНЕЦ МАРШРУТА** (Last waypoint; end of route) light will illuminate. 2 km after passing the last WP, the ROUTE Mode disengages, the **КОНЕЦ МАРШРУТА** light goes off, and the helicopter stabilizes on its current heading.

During this flight route process you will monitor the aircraft's position on the ABRIS map, control the automatic estimation of the navigation parameters, and compare the heading information of the HSI and the magnetic compass.

According to the flight plan, you may need to switch ADF channels and use the NDB bearing indication to properly navigate to the intended navigation points(s).

## Flight Director Control

When in flight director mode, the task of the pilot is to maintain the angular position of the helicopter with the cyclic and the altitude with the collective by using the directors indicated on the HUD and ADI.

This mode is most often used instead of automatic enroute flight.

To disengage the automatic mode and enable director control, it is necessary to press the **ДИР УПР** (FLT DIR) push-light on the Autopilot panel. By disengaging automatic control, the automatic angular stabilization is disabled but damping remains for all channels.

The joint pitch-bank director and altitude director appear on the HUD.

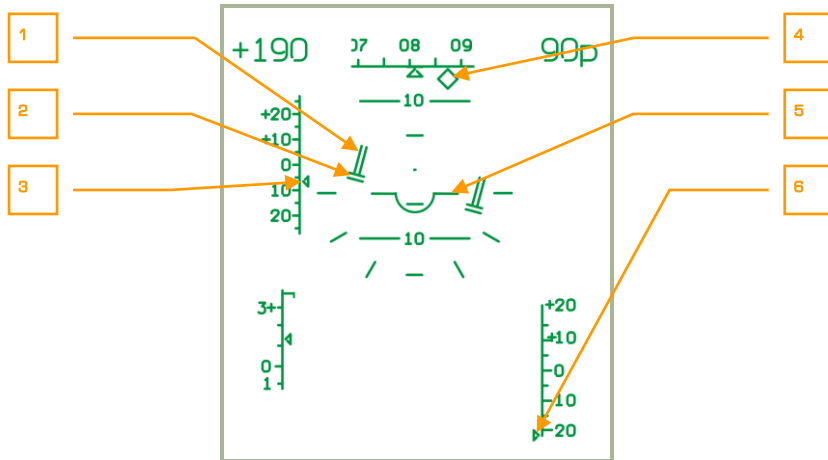

**6-1: Director control mode. The altitude and airspeed are below what is required.**

1. The altitude flight director indicates the needed altitude change.
2. The pitch-bank flight director indicates that it's necessary to set 15° right bank with slight negative pitch.
3. Index for deviation of the desired IAS indicates deviation from the desired speed -6 km/h.
4. The desired heading indicates a deviation of 7° to the left.
5. Aircraft datum.
6. The index for deviation of the desired true altitude indicates a deviation of more than -20 m (the index is at the bottom limit).

The desired airspeed is maintained by changing the pitch angle, and the altitude is changed by adjusting engine power.

When flying with director control, it is necessary to set the pitch and bank angles with the cyclic in reference to the aircraft datum. Use collective pitch adjustments to decrease the altitude director to the minimum. If the altitude director is "increasing" up, it's necessary to increase the collective pitch; if it's going down, decrease it.

In the example given above, the pilot must set a right bank of 15° with a small negative pitch (see 2), reach the desired speed (see 3, deviation -6 km/h), and increase collective pitch to gain the desired altitude (see 1 and 6, true altitude deviation more than -20 m).

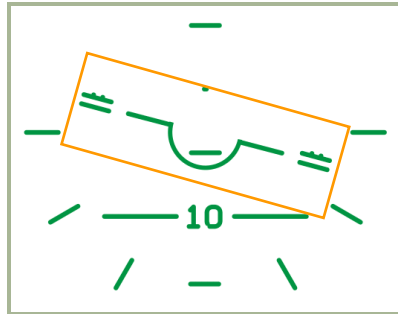

### 6-2: Director control mode. Correct maintaining of the desired regime.

To set a new airspeed and altitude, it is necessary to press and hold the trim button and change the speed and altitude. Then release the trim button and the current values of the airspeed and altitude are set as desired.

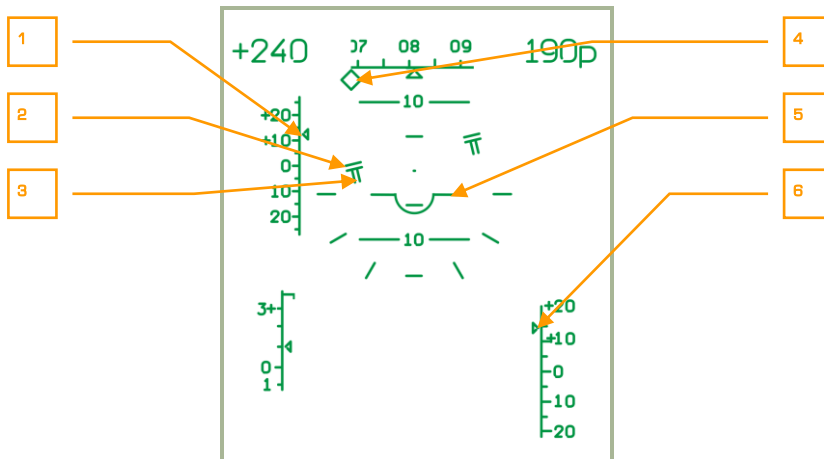

### 6-3: Director control mode. The altitude and airspeed are above what is required.

1. Index for deviation of the desired IAS indicates deviation from the desired speed +12 km/h.
2. The pitch-bank flight director indicates that it's necessary to set 15° of left bank with a slight positive pitch.
3. The altitude director indicates that it's necessary to descend.
4. The desired heading indicates deviation of more than 15° to the right.
5. Aircraft datum.
6. Index for deviation of the desired true altitude indicates a deviation of more than +15 m.

In this example the pilot must set a left bank of 15° with a slight positive pitch (see 2), reduce the speed to the desired value (see 1, deviation +12 km/h), and reduce the collective pitch to descend to the desired altitude (see 3 and 6, altitude deviation more than +15m).

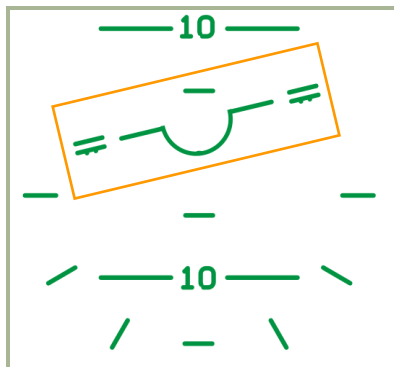

#### 6-4: Director control mode. Correct maintaining of the desired regime.

By pressing the “ДИР УПР” (FLT DIR) push-light on the Autopilot panel again, the flight directors mode is disabled and the automatic control is enabled.

## Changing WP Sequence in Flight

When you wish to change the WP sequence, you can perform the following procedure:

- Disengage ROUTE mode by setting the “МАРШРУТ-СНИЖЕНИЕ” (ROUTE - DESCENT) switch on the collective to the neutral position.
- Turn off the “ППМ” (Waypoints) push-light on the PVI-800 Navigation Control panel. This light and the WP indication number on the display will go out.
- Press the “ППМ” (Waypoints) push-light and it will illuminate.
- On the Navigation Control panel keypad, set the new first WP by pressing the corresponding keypad button. The number (WP), will then be visible on the display.
- Press the “ВВОД” (ENTER) push-light and the first WP will be saved into navigation computer memory.
- Repeat this process for the next five WPs.
- When complete, turn off the “ППМ” (Waypoints) mode. The new WP sequence will be saved in navigation computer memory.
- To activate the new route, press the “ППМ” (Waypoints) push-light again (the number of the first WP and navigation data will appear in the display) and check the correct flight direction to the new, first WP of the route.
- Engage ROUTE mode by setting the “МАРШРУТ-СНИЖЕНИ” (ROUTE – DESCENT) switch on the collective to the ROUTE position. According to the

selected DH or DT sub-mode, the **“МАРШРУТ ЗК”** or **“МАРШРУТ ЛЗП”** (DH ROUTE or DT ROUTE) lights will illuminate and the helicopter will initiate automatic turns to complete the new route.

## Ingress to a Target Point Using Route Mode

10 target points (TP) can be stored in the PVI-800 navigation system. Each TP coordinate is loaded into the navigation computer from the Mission Editor or manually while in flight. While in flight, the Route mode can be used to navigate from any WP to any selected TP by the shortest distance. This can be done with heading stabilization in DH or DT sub-modes.

In addition to an **“ОТ”** (TP) symbol on the HUD, the target's bearing and the distance are also displayed if the target is less than 100 km away.

Ingress procedure:

- Disengage ROUTE mode by setting the **“МАРШРУТ-СНИЖЕНИЕ”** (ROUTE - DESCENT) switch on the collective to the neutral position. This will cause the **“МАРШРУТ ЗК / МАРШРУТ ЛЗП”** (ROUTE DH / ROUTE DT) light to go off.
- Press the **“ППМ”** (WP) push-light on the Navigation Control panel and its light will go off, as well as the WP number indication on the display.
- Press the **“ОТ”** (TP) push-light and its light will illuminate.
- From the Navigation Control panel keypad, press the button with the TP number that appears on the display. Navigation data for automatic flight to the TP from the helicopter's current position is processed and indicated on the HSI, Navigation Control panel, and HUD.
- Engage ROUTE mode by setting the **“МАРШРУТ-СНИЖЕНИЕ”** (ROUTE – DESCENT) switch on the collective to the ROUTE position. The helicopter will then initiate an automatic turn towards the TP.

When approaching a TP, the **“КОНЕЦ МАРШРУТА”** (Last waypoint; End of route) light illuminates. 2 km after passing over a TP, the ROUTE Mode will disengage, the **“КОНЕЦ МАРШРУТА”** (Last waypoint; End of route) light will go off, and the helicopter will stabilize on its current heading.

## Return to Base Using Route Mode

Using Route mode, you may fly to one of the two pre-loaded airfields with heading stabilization in DH or DT sub-modes. The navigation data indications are the same as for a next WP.

Airfield ingress procedure:

- Disengage ROUTE mode by setting the **“МАРШРУТ-СНИЖЕНИЕ”** (ROUTE - DESCENT) switch on the collective to the neutral position. This will cause the **“МАРШРУТ ЗК / МАРШРУТ ЛЗП”** (ROUTE DH / ROUTE DT) light to go out.
- Press the **“ППМ”** (Waypoints) push light on the Navigation Control panel and its light and WP number on the display will go out.



- Press the “**АЭР**” (Airfield) push-light and its light will illuminate.
- From the keypad on the Navigation Control panel, press the button of the airfield number (1 or 2) that appears on the display. The navigation data for automatic route flight to the airfield from the helicopter’s current position is then processed and indicated on the HSI and Navigation Control panel.
- Engage ROUTE mode by setting the “**МАРШРУТ-СНИЖЕНИЕ**” (ROUTE – DESCENT) switch on the collective to the ROUTE position and the helicopter will initiate an automatic turn towards home base.

When approaching an airfield using this method, the (END of ROUTE) light will illuminate, and 2 km after passing over the airfield, the “**КОНЕЦ МАРШРУТА**” (Last waypoint; End of route) light will go off, as well as the Navigation Control panel indication. Automatic flight steering will then disengage and the helicopter will stabilize on its current heading.

## Route without Task

If a navigation task is not selected, meaning that no waypoint, target, or airfield is selected from the Navigation panel, it is possible to engage Route mode to maintain your current flight path. Thus, current flight path parameters like pitch, roll, yaw, and altitude are saved in the navigation system.

To engage Route mode without a task, switch off all task buttons on the Navigation panel: Waypoints, Targets, and Airfields.

The position of the Desired Heading – Desired Track Angle switch does not influence navigation.

- Stabilize the helicopter in level flight with the desired speed.
- Engage ROUTE mode by setting the “**МАРШРУТ-СНИЖЕНИЕ**” (ROUTE – DESCENT) switch on the collective to the ROUTE position and the helicopter will hold current flight parameters and bearing.

For changing flight parameters it is necessary to:

1. Press and hold the Trimmer on the cyclic stick.
2. Set new flight input (bearing, pitch and speed).
3. Release the Trimmer button.

During such flight, monitor the aircraft’s position on the ABRIS map and compare the heading information of the HSI and the magnetic compass.

According to the flight plan, you may need to switch ADF channels and use the NDB bearing indication.

## HOVER AND DESCENT MODES

### Hover

To hover automatically over a ground-point after decelerating to near-zero airspeed, you can engage HOVER mode using the following procedure:

- Set the "**МАРШРУТ-СНИЖЕНИЕ**" (ROUTE - DESCENT) switch to the neutral position.
- Press the "**ВИСЕНИЕ**" (HOVER) button on the cyclic and this will illuminate the "**ВИСЕНИЕ**" (HOVER) light on the overhead panel. The helicopter will then stabilize above the hover point; radar altitude stabilization mode will engage; and the "**Нрв СТАБ**" (RALT HOLD) light will illuminate on the overhead panel.

If there is any deviation from the initial hover point, the helicopter will automatically return to its initial position.

When HOVER mode is enabled, the following flight indications are provided:

- On the Attitude and Director Indicator (ADI) – Deviation from the set altitude and lateral position at Hover initiation is indicated by the pitch and bank flight directors.
- On the HSI – Longitudinal and lateral deviation from the hover point is indicated.
- On the HUD – Hover area and hover symbol deviation from the set hover altitude; flight directors for bank, pitch and altitude; commands for return to the desired hover point at the desired altitude, and a ground speed vector in any direction are all provided.

To disengage the Hover mode, press the HOVER button on the cyclic again and the HOVER light and all hover indications on the ADI, HSI, and HUD will be removed.

### Vertical Descent

If while in HOVER mode it is necessary to decrease altitude, you can use the VERTICAL DESCENT mode. To do so, press and hold the "**МАРШРУТ-СНИЖЕНИЕ**" (ROUTE - DESCENT) switch on the collective in the DESCENT position. When this is done, the "**ВИСЕНИЕ**" (HOVER) light and the "**Нрв**" СТАБ (RALT HOLD) lights will go off and the "**СНИЖЕН**" (DESCENT) light will turn on.

The helicopter will initiate a vertical descent with a sink rate of up to 2 m/s while stabilizing its position at the hover point and keeping the hover indication.

Upon reaching the desired altitude, set the DESCENT push-button back to neutral and thus cease the descent. The "**СНИЖЕН**" (DESCENT) light will turn off, the "**ВИСЕНИЕ**" (HOVER) and "**Нрв СТАБ**" (RALT HOLD) lights will illuminate, and HOVER mode will be implemented at the new altitude.



If the push-button is still held in the DESCENT position, the helicopter will descend down to 4m true altitude; after that the descent is cancelled.

## HELICOPTER COORDINATE CORRECTIONS

The Inertial Navigation Unit (INU) has a tendency to gradually accumulate errors due to imprecise sensors (gyroscopes and accelerometers) and due to the limitations of calculation methods. A cumulative error in coordinate calculations can be up to 4 km after 1 hour of flight.

Errors in coordinate calculations will affect flight path and determination of target locations. To compensate for these errors, they need to be corrected using one of two methods.

When planning a flight path in the mission editor, INU reference points need to be setup (up to 4 reference points). It is recommended to use locations that stand out in the terrain – buildings, towers, bridges, road crossings, and river merge points that are easily located along the route.

### Coordinate Corrections Using Over-flight Method

Once you are within 18 km of a reference point, the EKРАН will sound an audio cue and display **“ПРОВЕДИ КОРРЕКЦ КООРД”** (Perform Coordinates Correction).

To perform the correction:

1. On the PVI-800, press the **“ОП”** (Fix point) push-light and this will light up the button.
2. Press the key on the PVI-800 keypad that corresponds to this reference point number; this number will be displayed on the small right window.
3. Set **“И-251В – ПРОЛ”** (I-251V Shkval – Fly over) switch to **“ПРОЛ”** (Fly over) on the PVI-800.
4. Visually locate the reference point, fly towards it, and once located exactly above it press the **“ЦУ”** (Uncage Shkval – designate target) button on the cyclic. This will set the current coordinates in the onboard navigation system to the reference coordinates.

Once the correction is complete, the **“ОП”** push-light and its number will no longer be lit.

### Coordinate Corrections Using Shkval

If a reference point is not located along the flight route it is recommended to perform corrections using the I-251V Shkval.

To perform the correction:

1. On PVI-800 navigation control panel, press the **“ОП”** (Fix point) push-light which will light it up.

2. Press the key on the PVI-800 keypad that corresponds to this reference point number; this number will be displayed on the small right window.
3. Set **"И-251В – ПРОЛ"** (I-251V Shkval – Fly over) switch to **"И-251В"** (I-251V Shkval) on the PVI-800.
4. Visually locate the checkpoint on the terrain.
5. On the Targeting Mode Control Panel, set the **"ИЗЛ – ОТКЛ"** (Laser standby – Off) switch to **"ИЗЛ"** (Laser standby).
6. Press **"ЦУ"** (Uncage Shkval – designate target) on the cyclic (this will uncage the Shkval sensor).
7. Move the cursor over the reference point.
8. Adjust target tracking gate size to cover the reference point object and press the **"АВТ ЗАХВ"** (Auto-lock) button on the collective.
9. When the Shkval displays **"ТА"** (Autotracking), press **"ЦУ"** (Uncage Shkval – designate target) again on the cyclic. This will perform proper calculations to determine coordinate offset and store them in the navigation system as the helicopter's current coordinates.

During the calculation, the HUD will display the **"КОРР"** (Correction) message.

Once the correction is complete, press the **"СБРОС"** (Reset) button on the Targeting Mode Control Panel, which will clear the **"КОРР"** (Correction) message from the HUD, turn off **"ОП"** (Fix point) and reference point number on the PVI-800 navigation panel, and cage the Shkval.

## SPECIAL HARDWARE CONSIDERATIONS FOR CONTROLLING A HELICOPTER

Compared to the controls of a real Ka-50, the main difference in this simulation is the need to return the cyclic to a neutral position each time the trim button is activated. In the real aircraft, the cyclic remains in a trimmed position; this is only possible in this simulation if you are using a Force Feedback joystick.

It is highly recommended that you use some sort of rudder input device for controlling the helicopter direction. Three possible ways include:

- Rudder pedals
- Assign a joystick twist grip as rudder control
- Assigning the X-axis of a throttle mini-stick as the rudder control

The collective control in a helicopter is opposite to that in an airplane. In an airplane, you push the throttle(s) forward to accelerate and gain altitude. However, in a helicopter you pull back on the stick to increase power/lift. To achieve greater realism when controlling a helicopter simulation, it is recommended that you invert the throttle axis direction in your joystick configuration.

### Flight Controller Position Indicator

To better help users check the range and rate of response for their controllers, a flight controller's position indication can be displayed for cyclic, collective, throttles, and rudder. To toggle this indication on and off, press the [\[ENTER + RCTRL\]](#) key combination.

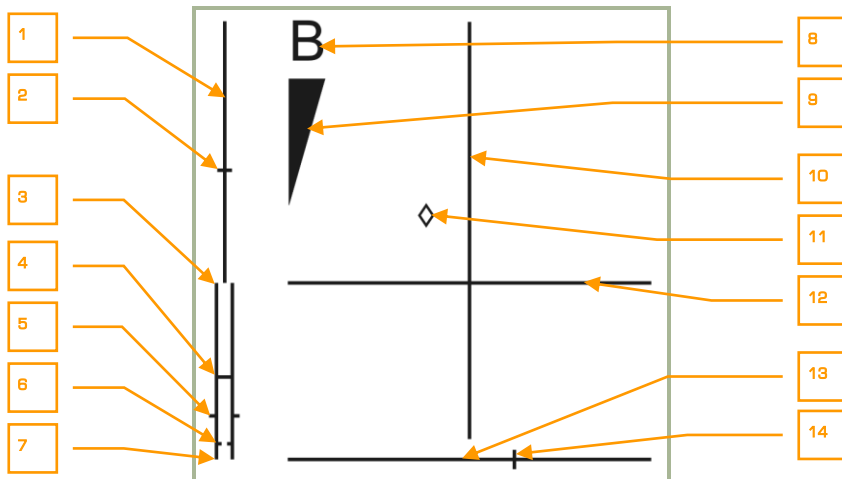

**6-5: Flight controller position indicator**



1. Collective position scale
2. Collective current position
3. Throttles scale. FULL mode position
4. Throttles scale. AUTO mode position
5. Throttles current position
6. Throttles scale. Engine limit governor failure (MEDIUM) mode position
7. Throttles scale. IDLE mode position
8. Wheels parking brake
9. Wheels brake scale
10. Pitch scale of cyclic
11. Cyclic current position
12. Bank scale of cyclic
13. Rudder scale
14. Rudder current position



**11**

**KA-50 COMBAT  
EMPLOYMENT**



## 7 KA-50 COMBAT EMPLOYMENT

Many factors affect survivability over the battlefield, usually complicated by such things as the need to aim and guide one's weapons and weather. When flying over the battlefield, always study the terrain before the mission and use it to your advantage; identify terrain masking and pop-up opportunities, then set up your navigation accordingly in order to minimize the effectiveness of ground defenses. Take note that small ground targets can be detected out to 10-15km on a good day, and target type can be determined at 5-10km when using the Shkval.

### Vikhr ATGM Employment Parameters

Minimum Safe Launch Altitude – Hover	10 m
Minimum Safe Launch Altitude – Forward Flight	50 m
Maximum Launch Altitude - Barometric	4,000 m
Maximum Launch Altitude – Practical/All Speeds	3,000 m
Minimum Range to Target	800 m
Maximum Range to Target	8,000 m

Descending below minimum launch altitude can result in ground collision due to increased pilot workload.

The Vikhr launcher can depress downwards up to 11°30'. The launcher will change elevation to match the HUD target marker only when the Vikhr is employed in its standard mode.

### Cannon Employment Parameters

Minimum Safe Altitude - Hover	10 m
Minimum Safe Altitude – Level Flight With Shkval	30 m
Minimum Safe Altitude – Level Flight Without Shkval	20 m
Maximum Altitude	5,000 m
Maximum Indicated Airspeed	300 km/h
Minimum Target Range	800 m
Maximum Target Range	2,000 m
Pitch Angle	±60°



## Preparations for a Combat Mission

If you properly prepare for a mission, your chances of completing it successfully improve dramatically. The most common steps that need to be considered in mission preparation are:

- Understand the mission objective, possible ways to achieve it, best weapons to use, and possible enemy resistance.
- Clarify route and flight profile.
- Analyze the area around targets, target types, and possible target defenses.
- Determine best Battle Positions (BP), if needed.
- If required, make adjustments and corrections to ingress and egress flight plan.
- Determine attack type and subsequent target attacks from different directions.
- Determine communications plan.



# COMBAT PROCEDURES

## General Guidelines

The primary means of flight and navigation for a single helicopter or group is to adhere to a set of pre-programmed waypoints (flight plan) that have been loaded into the Navigation Control system (PVI-800) and into the ABRIS. To minimize exposure to enemy air defenses, flight between the waypoints is generally conducted at the lowest possible safe-altitude to use terrain masking and clutter. Radar-guided air defense systems in particular will have difficulty tracking very low flying helicopters.

When flying over a rapidly changing battlefield, use target information received over the data link and displayed on the ABRIS map and search for additional targets and threats. When approaching a target zone, be careful to not rush in unprepared. Instead, take time to search the area with the Shkval and the wingman reconnaissance commands.

Be sure that the Tactical Situation display mode on the ABRIS screen is enabled. It will generally be on by default, but if not, you can activate it as follows:

1. Press the **MENU/OPTION** FSK.
2. Press the **SETUP** FSK.
3. From the pop-up menu, use the ABRIS cursor manipulator dial or UP or DOWN arrow FSK, to select CHARTS and then press the SETUP **FSK** again.
4. In TACTICAL SITUATION line you will see «+» (set by default). If not, and an «-» is displayed instead, press the **CHANGE** FSK.
5. Select the **NAV** (map) FSK twice.

Adjust the ABRIS map scale. To do this when in the **NAV** operating mode: press the **MAP** FSK and then **SCALE+** or **SCALE-** FSKs. Use them to adjust map scale as required and then return back to **NAV** operating mode by pressing **NAV** FSK.

When approaching the Forward Edge of Battle Area (FEBA):

1. Set appropriate weapon modes.
2. Set MASTER ARM switch to on.
3. Set the “ИЗЛ – ОТКЛ” (Laser standby ON/OFF) switch on the Targeting mode controls panel to the “ИЗЛ” (Laser standby ON) position.
4. Activate the UV-26 automatic flare dispensing program. Use a program suitable to the suspected air defense types.
5. Change flight formation as appropriate.

Leaving the FEBA:

1. Turn the MASTER ARM switch off.
2. Check condition of aircraft systems.



Perform evasive actions (a target flying straight and level is an easy target) and return to base according to the pre-programmed flight plan.

## Designate Target Points

The Ka-50 navigation-targeting system can store up to 10 Target Points (TP), which can be actual targets or ingress points. Setting a TP can be done in two ways:

- **Target Point fly-over.** In this scenario, the TP is the ground coordinate that the helicopter was flying over when the TP was created.
- **Shkval I-251 Designation.** Using the Shkval system and the laser rangefinder, a ground location can be designated and set as a TP. This is done by determining range and bearing between designation point and ownship.

### Fly-Over Target Point Designation

1. Set the Mode selector dial on the Navigation Control panel to the **"ВВОД"** (Enter) position.
2. Set **"И-251В – ПРОЛ"** (INU fix-taking method) switch to the **"ПРОЛ"** (Over-fly) position.
3. Press **"ОТ"** (Target point) push-light.
4. Select the TP number you wish to assign from the key pad (1...10).
5. Once above the target, press the **"ЦУ"** (Designate target) button on the cyclic and the helicopter's coordinates will be appear on the Navigation Control panel display. The **"ОТ"** (Target point) symbol will be displayed on the HUD.
6. Press the **"ВВОД"** (Enter) button on the Navigation Control panel a second time and the fly-over coordinates will be entered as a TP in the navigation system. The **"ОТ"** (Target point) symbol on the HUD will go out.
7. After creating the TP, set the Mode selector dial on the Navigation Control panel to the **"РАБ"** (Work) position.

### Shkval Target Point Designation

1. Ensure that the **"ИЗЛ-ОТКЛ"** (Laser standby ON/OFF) switch on the Targeting Mode Controls panel is set to the **"ИЗЛ"** (Laser standby ON) position.
2. Set the Mode selector dial on the Navigation Control panel to the **"ВВОД"** (Enter) position.
3. Set the **"И-251В – ПРОЛ"** (INU fix-taking method) switch to the **"И-251В"** (I-251V Shkval) position.
4. Press the **"ОТ"** (Target point) push-light button.
5. Select the TP number you wish to assign from the key pad (1-10).
6. Press the **"ЦУ"** (Uncage Shkval) button on the cyclic.



7. Use the sensor slew hat to align the HUD cursor with target point area, and then locate it on the Shkval display.
8. Place the Shkval target box over the target point area, adjust the gate size and press the **"АВТ ЗАХВ"** (Automatic target lock) button on the collective. The range to target area will now be displayed on the TVM screen.
9. Press the **"ЦУ"** (Designate target) button on the cyclic a second time and the target's coordinates will appear on the Navigation Control panel display. The **"ОТ"** (Target point) symbol will display on the HUD.
10. Press the **"ВВОД"** (Enter) button on the Navigation Control panel again and the derived coordinates will be entered as the TP coordinates in the navigation system. The **"ОТ"** (Target point) symbol on the HUD will go out.
11. After creating this new TP, set the Mode selector dial on the Navigation Control panel to the **"РАБ"** (Work) position. On the Targeting Mode Controls panel, press the **"СБРОС"** (Targeting mode reset) button.

## Designate Targets and Ingress Points for Data Link

Prior to designating targets and ingress points to other wingmen over the data link, the follow steps need to be followed:

1. Ensure that all flight members are tuned to the same VHF radio data link frequency.
2. Turn on the **"ТЛК"** (Data link radio equipment) switch and the **"УКВ-ТЛК"** (Data link VHF radio equipment) switch on the wall panel and the **"ВЦУ - ОТКЛ"** (Data link power) switch on the Navigation Control panel.
3. Ensure that the **"ИЗЛ-ОТКЛ"** (Laser standby) switch on the Targeting Mode Controls panel is set to the **"ИЗЛ"** on position.
4. Set data link **"КТО Я"** (Self ID) dial on the Off Board Targeting Data Link panel to the appropriate helicopter ID (your helicopter) in the group (1-4). The flight lead should always be set to 1.
5. Set data link **"РЕЖИМ"** (Master Mode) knob on the Off Board Targeting Data Link panel to the **"КОМ"** (Commander – send and receive data. Leader mark on the ABRIS) position. If you are not the flight lead, set knob on the Off Board Targeting Data Link panel to the **"ВЕДОМ"** (Wingman – send and receive data. Wingman mark on the ABRIS) position.

Determining a target's coordinates (or ingress point coordinate) with the Ka-50 can be done using the Shkval I-251 and laser rangefinder. This designation in relation to the know coordinates of your aircraft provide accurate target coordinates that can be sent over the data link. The following eight steps describe the process for *creating* data link targets that will show up on the ABRIS. See the next section for *sending* the targets you create.

1. Press the **"ЦУ"** (Uncage Shkval) button on the cyclic.
2. Use the sensor slew hat to align the HUD cursor over the target area and locate the target/location on the Shkval display.

3. Determine the target type and class, by zooming in from 7x to 23x.
4. Place the Shkval target box over the target, adjust the tracking gate size, and press the automatic target lock button on the collective.
5. Set the target type or ingress point on the Data Link Control Panel (the corresponding button will light ).
6. On the Data Link Control Panel, press the "ПРД/ПАМ" (transmit /memory) button to place the target in memory. On the ABRIS, the corresponding target symbol with assigned number will appear.
7. If necessary, repeat steps 1-6 to create additional targets.
8. When done creating targets, press the "СБРОС" (Reset) button "ПБР" on the Targeting Mode Control panel, and this will reset the Shkval LOS to default/boresight.

## Data Exchange between Helicopters

Target coordinate information can be passed to other flight members using the following procedure:

1. Select target type on Data Link Control Panel:

 /1 – Combat vehicle, Armor

 /2 – AAA/SAM

 /3 – Other

 – Ingress Point

The selected button will light on the Data Link Control Panel.

2. Select the helicopter flight number on the Data Link Control Panel that is to receive the data, or select the "БСЕМ" (TO ALL) button to send to all flight members (the selected button will light up on the Data Link Control Panel, and the recipient's icon will flash on the ABRIS).
3. If there is more than one target of the same type in system memory, you will need to go back and press the target type button on the Data Link Control Panel as many times as required to cycle through all targets of the same type in memory; each press of the target type button will select the next target of that type, and the corresponding target symbol will flash on the ABRIS.

It is important to note that if no recipient is chosen before this step, pressing the target type button will not scroll through your targets on the ABRIS, and nothing will be sent. You must choose a target type, then the recipient, and then *go back* to the target type button in order to scroll through targets on the ABRIS. Do not push the send button (step 4) until you have a target symbol and flight member icon flashing on the ABRIS. The exception to this: if you have selected the "БСЕМ" (TO ALL) button, none of the flight member icons will flash on the ABRIS.



4. Press the **"ПРД/ПАМ"** (Send/Memory) button on the Data Link Panel to send the data to the selected flight members (all lights on the Data Link Panel will go out).
5. On the ABRIS, the selected target marker symbol and flight member icon will stop blinking and stay solid.

If the receiving flight member(s) successfully received and acknowledged data receipt, all the lighted Data Link Panel buttons will turn off. If data receipt is not acknowledged, the **"ПРД/ПАМ"** (Send/Memory) button will start blinking. In such a case, press the **"ПРД/ПАМ"** (Send/Memory) button again and this will turn off the lighted **"ПРД/ПАМ"** (Send/Memory) button, as well as the receiver number, target number, and target marker symbol on the ABRIS. If **"ВСЕМ"** (TO ALL) was selected, the lighted buttons will turn off regardless of successful data receipt acknowledgement.

When handing off target data to a flight member(s) without first creating a target on the ABRIS, (i.e. using Shkval tracking) leave the target type button unpressed, press intended recipient number, and then press the **"ПРД/ПАМ"** (Send/Memory) button on the Data Link Panel. The coordinates on the ground where the Shkval is locked will be sent to the recipient(s).

To delete Data Link targets created on the ABRIS:

1. Press the **"СБРОС"** (Reset) button **"ПВР"** on the Targeting Mode Control panel. The Shkval must be in standby mode in order to delete targets.
2. Press the target type button on the Data Link Control Panel. If multiple targets of this type exist, press the target type button again until the target you want to delete is flashing on the ABRIS.
3. Press the **"СТИР"** button on the Data Link Control Panel. The selected target on the ABRIS will disappear, and the remaining targets of that type will be renumbered.

To send Target Point coordinates created in the PVI-800 navigation system:

1. Press the **"ОТ"** (Target point) push-light button on Navigation Control panel (button will light up).
2. Select the TP ID using the Navigation Control panel keypad. The number will then be displayed on the Navigation Control panel display and the ABRIS will have a blinking marker point as well.
3. Press the desired target type or ingress point push-light button on the Data Link panel (button will light).
4. Select recipient(s) number or all (button will light).
5. Press the **"ПРД/ПАМ"** (Send/Memory) button (button will light briefly).

Once acknowledgement has been received, all lights on these buttons will turn off.

## Using Data Link when Approaching a Target Area

Prior to approaching the target area, each wingman will need to set their **"РЕЖИМ"** (Data Mode) dial to receive data link information in either **"ПРИЕМ"** (Receive only),



**"ВЕДОМ"** (Wingman – send and receive data. Wingman mark on the ABRIS) or **"КОМ"** (Commander – send and receive data; leader mark on the ABRIS) modes. You can also disable data link communications with the flight by using the **"ОТКЛ"** setting.

When receiving target data, the Voice Messaging Unit (VMU) will announce **«Принять ЦУ»** (received target data). At the same time, the Data Link Panel will have lighted buttons according to target type or ingress point received, and sender's flight number.

Once data is received when you are in **"ВЕДОМ"** (Wingman) mode, the acknowledgement is sent automatically.

With target data received, you can save the data. To do this, press the **"ПРД/ПАМ"** (Send/Memory) button on the Data Link Panel (ABRIS will now show a non-blinking target marker and the Data Link Panel buttons will stop blinking).

## Automatic Ingress to Target

When approaching the target area and you wish to point the aircraft at a data linked target, you should:

1. Press the desired target type button (press as many times as needed to select required target) and the ABRIS will show the flashing target symbol.
2. Press the **"ВЫХОД"** (Ingress) button on the Data Link Panel (the button will light and the target type button light will turn off), then set the **"ЗК/ЛЗП"** (Autopilot heading DH/DTA) switch on Autopilot Panel to the **"ЗК"** (Desired heading) position, and set the **"СНИЖ-МАРШРУТ"** (Descent – Route) switch on the collective to the **"МАРШРУТ"** (Route) mode.
3. Press the **"АДВ"** (Automatic turn to target) button on the Targeting Mode Control panel and this initiates the "automatic turn to target" mode. The target marker on the ABRIS will stop flashing and it will be marked with a cross.

At the same time on the HUD, the relative target bearing will instead show range to target, while the HSI will show target bearing and range.

When approaching a target within 8 km, press the **"ЦУ"** (Uncage/Designate target) button on the cyclic and begin searching for the target with the Shkval sensor. If necessary, turn on the Shkval's scanning mode by pressing the **"ЦУ"** again.

Once a target is detected, slew the cursor to the target to turn scanning off, adjust the tracking gate size, and turn on automatic tracking.

To turn target ingress mode off, press the **"ВЫХОД"** (Ingress) button again.

## Sending Recon Orders to Flight Members

The flight lead can assign reconnaissance tasks to any of his flight members.

The procedure is as follows:

1. Select the radio commands menu [V].
2. Select wingman.



3. Select Recon menu.
4. Select required recon distance or data link point.

Once the order is received, the flight member will start moving at low altitude along the same heading as the flight leader while scanning for targets.

Information about any detected target(s) will be passed to the flight leader through the data link.

**Note: Target detection range depends on flight member's skill level.**

- Excellent – detects targets out to 8 km
- High – detects targets out to 6 km
- Average – detects targets out to 4 km

## Shkval Scan Mode

While performing combat and navigation tasks, the pilot can automatically scan for targets using the Shkval's scan mode. This mode scans a  $\pm 10^\circ$  sector relative to the helicopter's current heading.

Shkval scanning procedure:

1. Press the **"АДВ"** (Automatic turn on target) button and the **"НПЦ"** (Ground moving target) button which are located on the Targeting Mode Controls panel. If using the HMS, turn on the **"ОБЗОР"** (Helmet mounted target designator) as well.
2. Press the **"ЦУ"** (Uncage/Designate target) button on the cyclic and place the cursor within the desired search area using the sensor slew hat.
3. Turn on the Shkval scan by pressing the **"ЦУ"** button again. The Shkval sensor will then start moving side-to-side within  $10^\circ$  of the initial position.
4. You can adjust the scan speed by using the **"СКАНИР"** (Scan rate) knob on the right panel. The scan rate can range from 0.25 to 3 degrees per second.

Stop the scan once a target is detected by moving the sensor slew hat in any direction. Zoom in on the target if required by switching to narrow FOV with the **"ШПЗ – УПЗ"** (Wide – Narrow) switch on the collective. Press **"ЦУ"** again to resume scanning.

To adjust the scan zone:

- Use the sensor slew hat to move the Shkval cursor to the desired scan area.
- Turn on scanning again by pressing the **"ЦУ"** button and scanning will resume in this new area.

To turn off scanning, press the **"СБРОС"** (Targeting mode reset) button on the Targeting Mode Controls panel; this will stop the scan and reset the Shkval to the default boresight position.

## WEAPONS EMPLOYMENT PREPARATIONS

Weapons systems are ready to be employed when the following conditions are true.

- For the cannon, the Weapon Status and Control panel: **“ОСТАТОК ВПУ”** (Gun rounds remaining) will indicate cannon rounds remaining in multiples of ten; «25» indicates that the selected round type has 250 rounds.
- Yellow indicators under the helicopter symbol indicates the presence of weapons on those hardpoints.
- Weapon Status and Control panel: the **“ТИП”** (Weapons type) indicator will show the selected weapon type according to the position of the hardpoint selector switch, **“ВНЕШН-ВНУТР”** (Outer – Inner): HP (Rockets), **“ПС”** (ATGM), **“АБ”** (Bombs) or **“СП”** (Gun pods).

### ATGM Employment

Targeting Mode Control panel:

1. The **“ОСН РЕЖ”** (Weapon system mode selector) dial should be set according to weapon system mode. **“ППУ”** (Moving cannon) is the primary automatic operative mode.
2. Set the **“ИЗЛ – ОТКЛ”** (Laser standby - Off) switch to the **“ИЗЛ”** (Laser standby) setting.
3. Set the **“АС – ПМ”** (Auto-tracking – Gun sight) switch to the **“АС”** position for auto-tracking.
4. Press the **“НПЦ”** (Ground moving target) button to enable tracking of moving ground targets.

Weapon Status and Control panel:

1. The **“РУЧН – АВТ”** (Manual/Auto weapon system control) switch should be set to the **“АВТ”** (Auto) position.
2. The **“ДЛ – СР – КОР”** (weapon mode switch – burst length) switch should be set according to the desired launch mode. **“ДЛ”** (long) or **“СР”** (Medium) will launch two missiles and **“КОР”** (Short) will launch one missile.
3. The **“ВНЕШН – ВНУТР”** (Outer – Inner hardpoints) switch on the collective should be set to the **“ВНЕШН”** (Outer) position. This will be indicated on the Weapon Status and Control panel by two green lamps that indicate that ATGM missiles are ready for employment.
4. Master Arm switch – set to ON.

## Rocket Employment

Weapon Status and Control panel:

- Set the **"ДЛ – СР – КОР"** (weapon mode switch – burst length) switch according to desired launch mode.  
**"ДЛ"** (Long) – will launch 10 rockets (half) from each launcher.  
**"СР"** (Medium) – will launch five rockets (quarter) from each launcher.  
**"КОР"** (Short) – will launch one rocket from each launcher.

Master Arm switch – set to ON.

Select which hardpoint to launch rockets from by setting the **"ВНЕШН – ВНУТР"** (Outer – Inner hardpoints) switch to inner, – outer - all. The selected hardpoints will be indicated with green lights, and the number of remaining rockets will be indicated.

## Cannon Employment

Targeting Mode Control panel:

1. The **"ОСН РЕЖ"** (Weapon system mode selector) dial should be set according to weapon system mode.  
Select **"ППУ"** to allow the cannon to be slaved to the Shkval. This is the primary mode.  
Select **"НПУ"** to fix the cannon along boresight as a backup control mode.
2. Set the **"ИЗЛ – ОТКЛ"** (Laser standby - Off) switch to the **"ИЗЛ"** (Laser standby) setting.
3. Set the **"АС – ПМ"** (Auto-tracking – Gun sight) switch to the **"АС"** position for auto-tracking, or select **"ПМ"** (Gun sight) to aim the cannon manually with helicopter controls.
4. Press the **"НПЦ"** (Ground moving target) button to enable tracking of moving ground targets.

Weapon Status and Control panel:

1. Set the **"РУЧН – АВТ"** (Manual/Auto weapon system control) switch according to the desired firing mode:  
**"АВТ"** – main gun mode slaved to Shkval with authorized fire range calculation.  
**"РУЧН"** – backup mode without authorized fire range calculation.
2. Set the **"ДЛ – СР – КОР"** (weapon mode switch – burst length) switch according to:  
**"ДЛ"** (Long) and **"СР"** (Medium) – 20 rounds in a burst.  
**"КОР"** (Short) – 10 rounds in a burst.
3. Set the **"МТ – БТ"** (Cannon rate of fire) switch according to:  
**"МТ"** (Slow ROF) – 300 rounds per minute.  
**"БТ"** (High ROF) – 600 rounds per minute.





4. Set the **"ОФ – БР"** (HE – AP rounds selector) switch to select the desired round type:  
**"ОФ"** – high explosive rounds.  
**"БР"** – armor piercing rounds.
5. Master Arm switch – set to ON.

## Bombs Employment

The helicopter's weapon system does not have impact or release point calculation release modes. You must calculate the release point manually.

The switches on the Weapon Status and Control panel do not affect bomb release.

1. Set Master Arm switch – set to ON.
2. Select hardpoints with bombs by setting the **"ВНЕШН – ВНУТР"** (Outer – Inner hardpoints) switch – inner – outer or - all. The selected hardpoints will be indicated with **"АБ"** (Bombs) and green lights. The number of remaining bombs will be indicated.

## Returning to Weapons-safe Condition

1. To prevent the weapons from accidental use, press the **"СБРОС"** (Targeting mode reset) button on the Targeting Mode Control panel.
2. Confirm from the overhead message lamps panel that the **"ППУ"** (Cannon operative) light has turned off if the cannon was used.
3. Master Arm switch should be set to OFF.

## AUTOMATIC INGRESS TO TARGET AREA

Prior to using the automatic ingress function of the Ka-50, you will need to set up the Targeting Mode Control panel and Weapon Status and Control panels as follows:

1. Press the **"АДВ"** (Automatic turn-on target mode) button on the Targeting Mode Control panel.
2. Select the **"ОБЗ – ОТКЛ"** (Helmet-Mounted Target Designator system power) switch on Targeting Mode Control panel to the **"ОБЗ"** (On) position when using helmet targeting mode; otherwise, set it to the **"ОТКЛ"** (Off) position.
3. Set the **"ИЗЛ – ОТКЛ"** (Laser standby - Off) switch to the **"ИЗЛ"** (standby) position.
4. Set the **"АС – ПМ"** (Auto-tracking – Gun sight) switch to the **"АС"** (Auto-tracking) position.
5. Set the **"ШПЗ – УПЗ"** (Wide FOV – Narrow FOV) switch on the collective to the **"ШПЗ"** (Wide FOV) position.

Ensure that the targeting marker from the HMS and HUD, video image, and FOV limits are displayed on the Shkval IT-23 display.

### Using Shkval to Lock Target

Estimate the approximate target location and point the helicopter in that direction. Then perform the following steps:

1. Press the **"ЦУ"** (Uncage Shkval, designate target) button on the cyclic and slew the targeting cursor over the target area.
2. Examine the Shkval display, locate the target, and switch to the narrow FOV to determine target type.
3. Adjust placement of the targeting cursor by using the sensor slew hat to position the cue over the target.
4. Adjust the size of the tracking gate by using the **"ПАМКА М – Б"** (TV target frame Increase – Decrease size) switch on the collective.
5. Control the helicopter's flight stability as it turns towards the target.
6. On target approach, adjust the targeting cursor position and size if necessary.

### Using HMS to Lock Target

Estimate the approximate target location and point the helicopter in that direction. Then perform the following steps:

1. On approach to the target area, select the **"ОБЗ – ОТКЛ"** (Helmet-Mounted Sight system power) switch on the Targeting Mode Control panel.



2. Using head movement, place the targeting cursor over the target and press the **"ЦУ"** (Uncage Shkval, designate target) button on the cyclic. This will display the "Processing" HMS symbol (two concentric circles with a flashing cross). Keep the **"ЦУ"** button depressed until the «processing complete – target lock» signal is received. This is indicated by two concentric circles and a solid, stable cross on the HMS display.
3. Release the **"ЦУ"** button. When the button is pressed, the automatic turn-to target will begin. The HUD will display navigation and targeting data and the HUD target mark will align with the helmet target mark.
4. When the **"ЦУ"** button is pressed and the helmet position angle is within the Shkval FOV, the Shkval line of sight will position over the helmet target marker.
5. If the helmet angle is outside the angular confines of the HUD, the HUD target mark will position itself at the closest maximum angle and the helmet display will display a flashing auto-turn signal (two flashing concentric circles and flashing cross). The helicopter will now automatically turn towards the target. Once the angles are within limits, the auto-turn signal disappears and the HUD targeting marker will align with helmet targeting marker. The helicopter will continue to turn itself to align with the target.
6. Keep helmet targeting marker over the target and keep the **"ЦУ"** button depressed until you receive the «processing complete – target lock» message. After this, release the **"ЦУ"** button and the Shkval targeting marker will be positioned roughly over the target. If the **"ЦУ"** button is released during the auto-turn, the auto-turn will be performed to the last marker position where the button was kept pressed.
7. Adjust the helicopter's position manually if required.
8. Verify that the targeting mark is aligned with the target on the HUD and examine the Shkval IT-23 display. Locate the target in wide FOV and then positively identify it in narrow FOV.
9. Adjust the tracking gate size using the **"ПАМКА М – Б"** (TV target frame Increase – Decrease size) switch on the collective.
10. Continue to adjust the automatic turn and flight stability.
11. On target approach, adjust the targeting cursor position and size if necessary.



## WEAPONS EMPLOYMENT IN AUTOMATIC MODE

### ATGM Employment

When approaching the target area, perform the following Shkval adjustments:

1. Use the sensor slew hat on the cyclic and the **"ПАМКА М – Б"** (tracking gate increase – decrease size) switch on the collective to adjust target box position and size.
2. Press the **"АВТ ЗАХВ"** (Lock target) button on the collective. This will ground stabilize the Shkval sensor line of sight.
3. When the **"ТГ"** symbol and distance to target appear on the Shkval display, place the target marker over a valid target and press the lock target button a second time. You will then see the **"ТА"** (auto-tracking target) symbol on the Shkval display and the **"ТА-ИД"** (auto-tracking target – range indicator) symbol on the HUD. Assuming you have a Vikhr selected as the active weapon, a launch circle indicating target range and Vikhr launch range will be displayed on the HUD.
4. When approaching the target, correct the tracking gate position and size if necessary. To make adjustments, press and hold lock target button while making adjustments.

When approaching the maximum Vikhr launch range, perform the following:

1. Maneuver the helicopter to align it in the horizontal axis with the target. This will best align the Vikhr launchers with the target (align launch circle with target line-of-sight on the HUD), and maintain this heading for at least one second.
2. Adjust tracking gate if necessary.

When the **"С"** Launch Permission symbol appears on the HUD, perform the following:

1. Press the weapon launch button and keep it pressed until the missile has launched; this usually takes about one full second. Just tapping the weapon launch button will not suffice.
2. After the missile has launched, verify that the laser rangefinder has switched from **"ТА-ИД"** (auto-tracking target – range indicator) to **"ТА-ИУ"** (auto-tracking target – laser-beam control) on the HUD and that the time-to-impact in seconds also appears.
3. Adjust tracking gate if necessary.
4. If the target moves outside the HUD FOV, the Shkval gimbal limit zone rectangle will appear on the HUD. This indicates the line of sight mark in the zone scale. When approaching within 5° from gimbal limit angles, the line of sight mark will start flashing. Maneuver the helicopter back towards target azimuth until the flashing stops (to avoid losing the missile control).

5. The attack will end if the missile has reached the target, time to impact plus an additional six seconds have passed, or the "X" cross has appeared on the HUD.

## Vikhr ATGM Launch Procedure

### Approaching the target area

#### Pilot actions:

Choose weapon –Vikhr ATGM

Collective:

1. Select outer weapon hardpoints. The Weapon Status and Control panel will indicate "**ОСТАТОК**" (Remains) – 12 or 6 and "**ТИП**" (Type) – "**ПС**" (ATGM).
2. Select narrow Field of View (FOV).

Weapon Status and Control panel:

1. Set the "**ДЛ – СР – КОР**" (weapon mode) switch to the "**КОР**" (Short) position to launch a single missile.
2. Set the "**РУЧН – АВТ**" (weapon control) switch to the "**АВТ**" (Auto) position.
3. Set Master Arm switch to ON.

Targeting Mode Control panel:

1. Set the "**ОБЗ – ОТКЛ**" (Helmet-Mounted Sight) switch to the "**ОБЗ**" position. The helmet target marker will then be displayed.
2. Set the "**ИЗЛ – ОТКЛ**" (Laser standby) switch to the "**ИЗЛ**" position.
3. Press the "**НПЦ**" (Ground moving target) button.
4. Press the "**АДВ**" (Automatic turn to target mode) button.

Targeting Display Control panel:

1. Adjust HMS brightness with the "**НВУ**" control knob.
2. Adjust Shkval IT-23 display brightness and contrast.
3. Set the "**ОГР ИНФ – ПОЛН**" (HUD/TV declutter) switch as desired. In "**ОГР ИНФ**" (Declutter) position, the pitch, bank, speed, and aircraft symbols are not displayed.

The following data will be indicated on the HUD and Shkval IT-23 display:

- HUD – Indications of flight and navigation information. When altitude is less than 50 m, indication will be in radar altitude scale.
- Shkval display – Displays EO sensor video at appropriate FOV.

### Using the HMS with Vikhr

Helmet Mounted Sight (HMS) system displays targeting information as shown below:

## Normal Operation

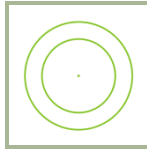

## Setting Target Area

Assuming a target with an azimuth greater than  $30^\circ$  is off the nose, begin initial targeting procedures.

Slew (move your head) the HMS target marker to align with the target. Press and hold the "CY" button on the cyclic.

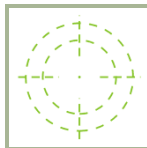

The HMS target marker will look like the image above.

The HUD will show the Shkval rectangle gimbal limit zone:  $+10^\circ$  to  $-85^\circ$  in the vertical and  $\pm 30^\circ$  in the horizontal, with line of sight mark to target within this zone. Also, instead of the heading scale, there will be a relative target angle scale ( $\pm 30^\circ$ ) with a relative target angle symbol.

The helicopter will then begin an automatic turn to target.

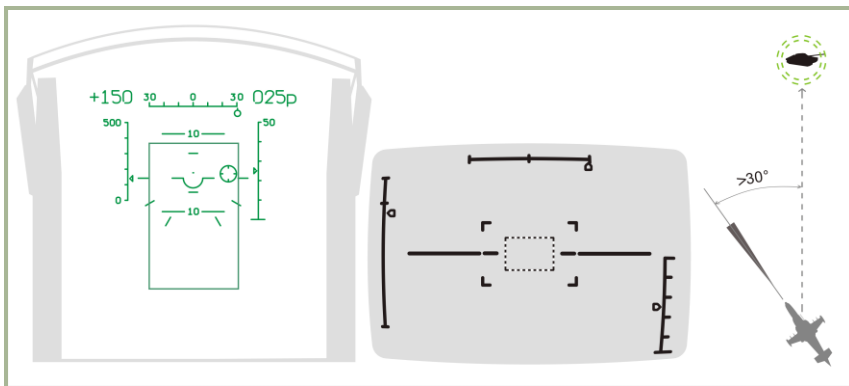

**7-1: HUD, Shkval, and HMS indication when setting target area**

## Automatic Turn to Target

While the helicopter is rotating, continue to align the HMS target mark over the target.

When angle to target is less than  $30^\circ$ , the Shkval gyrostabilizer will uncage. The HUD will no longer show the Shkval rectangle gimbal limit zone and will instead show true target angle.

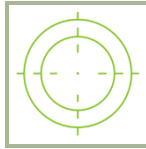

When the PROCESSING indication appears on the HMS, release the “ЦУ” button. When the Shkval has finished processing, the HMS will display the TARGET LOCK indication. The target will also be centered on the Shkval IT-23 display.

Further target marker adjustments should be performed with sensor slew hat.

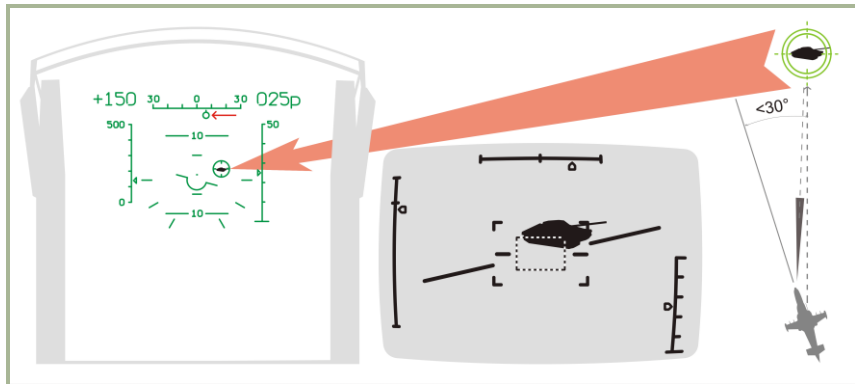

## 7-2: HUD, Shkval, and HMS indications during automatic turn to target stage

### Target Acquisition from Shkval Display

Ensure that the target is located within the HUD field of view and is within  $\pm 5^\circ$  of center.

Positively identify the target to avoid friendly fire by switching to the narrow FOV on the Shkval display. If the target is not visible in narrow FOV, switch to wide FOV and slew the targeting marker until the target is found. Once the target is found, return to narrow FOV.

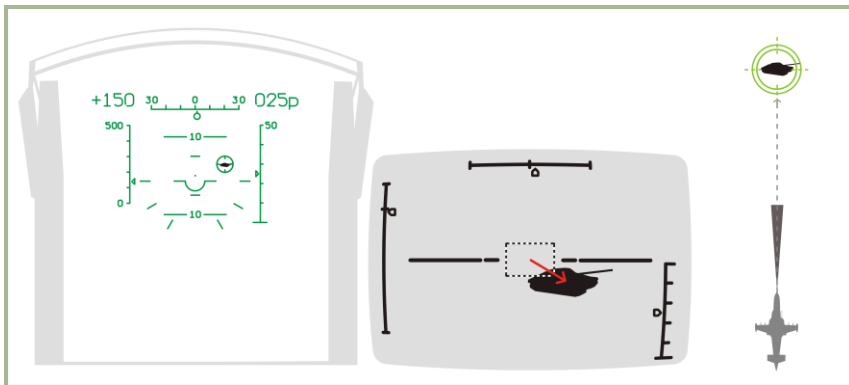

**7-3: HUD, Shkval, and HMS indications during Shkval target acquisition stage**

### Target Auto-tracking

Adjust the tracking gate size by using the “**ПАМКА М – Б**” (TV target frame Increase – Decrease size) switch on the collective.

When the “**ТГ**” (tracking ready) symbol appears, press the “**АВТ ЗАХВ**” (Automatic target lock) button. Release it when target range is indicated. When the “**АВТ ЗАХВ**” button is pressed, the laser rangefinder is turned on for approximately three seconds. The HUD displays the “**ИД**” symbol and shows remaining time until range-finding will be complete.

The target will now be in auto-tracked mode, indicated on the HUD and Shkval display by the “**ТА**” (target locked), along with target range.

Additionally, the missile launch zone appears on the HUD along with current, maximum, and minimum launch distances.

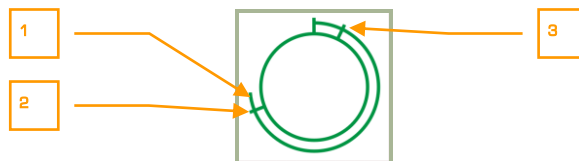

1. Current range to the target
2. Maximum launch range
3. Minimum launch range

The HMS will display the following symbol that indicates the target is auto-tracked.



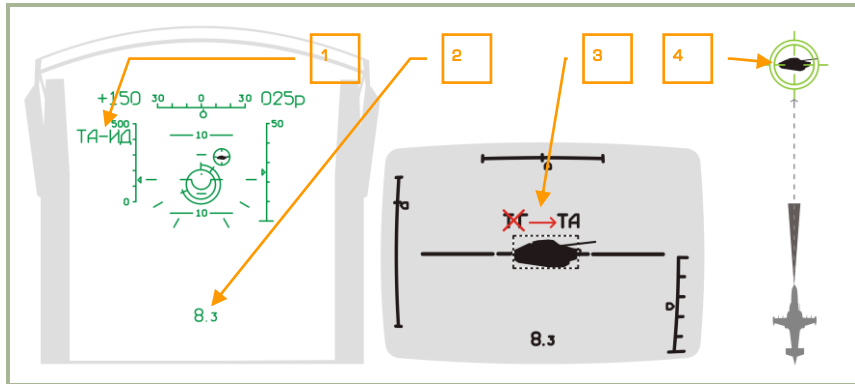

#### 7-4: HUD, Shkval, and HMS indications during auto-tracking stage

1. "ТА-ИД" (Auto-tracking target – range indicator)
2. Range to target
3. "ТГ" (tracking ready) changes to "ТА" (target locked)
4. Helmet mounted sight indication

#### Aiming

Upon reaching maximum launch range, maneuver the helicopter to position the target marker within the missile launch zone reticle. Once aiming is complete, the target line-of-sight symbol will be within the missile launch zone reticle.

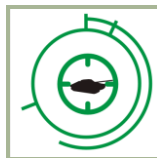

When range to target is within permitted values and the helicopter's angular speed does not exceed 3-degrees per second, both the HUD and Shkval TVM display the "С" (launch permitted) symbol. The HMS changes to indicate LAUNCH AUTHORIZED.



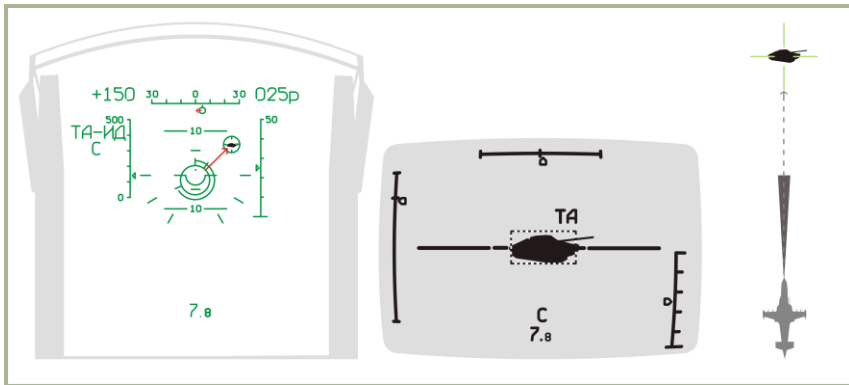

**7-5: HUD, Shkval, and HMS indication during aiming stage**

### Launching a Missile

Once the “C” symbol appears, verify that the “TA” symbol is also on HUD and Shkval TVM and launch the missile by pressing and holding the weapon release button on the cyclic until missile has launched.

When the weapon release button is pressed, the missile laser-beam control channel is automatically activated.

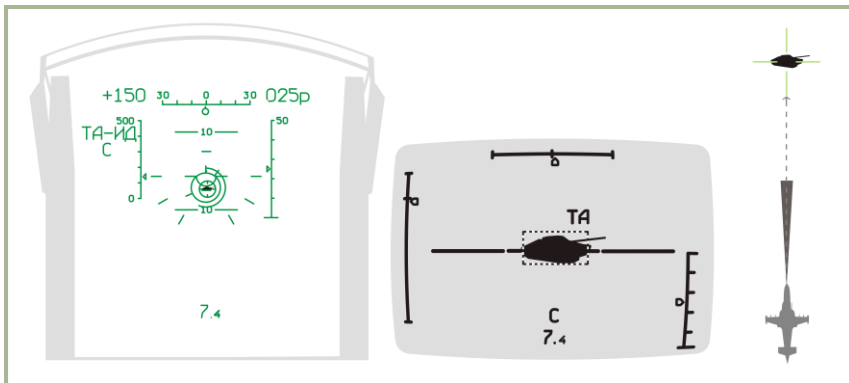

**7-6: HUD, Shkval, and HMS indications during launch stage**

### While the Missile is in Flight

While the Vikhr missile is in flight, maintain the helicopter’s current heading such that it does not exceed the Shkval’s angular gimbal limits. Try to avoid high angular velocity that can cause missile to lose the laser-guidance beam.

- Laser-beam control channel activated
- The “TA-ИУ” symbols (auto-tracking target – laser-beam control) will appear

- Time to Impact count-down timer will appear

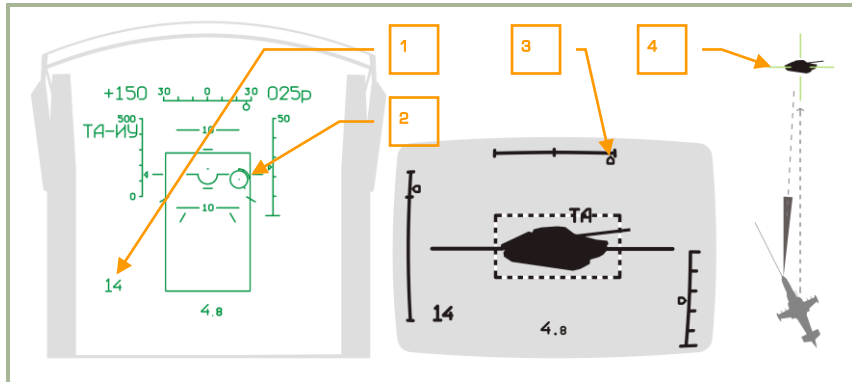

### 7-7: HUD, Shkval, and HMS indications while missile is in flight

1. Estimated time to impact + 6 seconds
2. Target marker with range to target inscribed
3. Flashing angle indicator when approaching Shkval gimbal limits
4. Helmet mounted sight indication

### End of attack and Egress

After the missile has hit its target (or ground), or when reaching the minimum launch distance, press the “**СБРОС**” (Reset) button on the Targeting Mode Control panel and turn away from the target. As a rule, you should never over-fly your target.

When within weapon minimum range, the HUD and HMS will display a “launch prohibited” flashing “X” symbol.

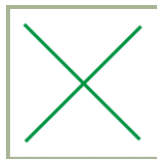

After the “**СБРОС**” (Reset) button is pressed, the Shkval will be caged, target tracking and laser-beam channel is turned off, the selected weapon type is reset, and system switches to NAV mode.

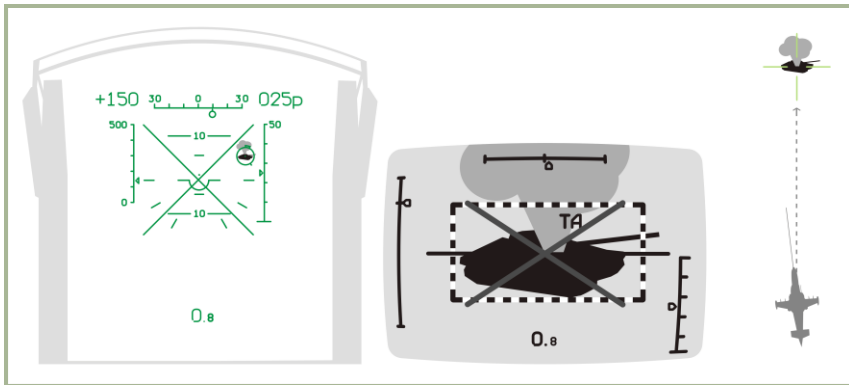

**7-8: HUD, Shkval, and HMS indications after attack**

## Using the 2A42 Cannon with Auto-tracking

To use the 2A42 30mm on-board cannon with auto-tracking, perform the following steps:

1. Select the 2A42 cannon. This will display the cannon's range of motion as a "gate" box on the HUD. The box will be biased to the right because the cannon is mounted on the right side of the helicopter.
2. Maneuver the helicopter to place the target / target marker within the gate.
3. Confirm that target is locked and is being auto-tracked.
4. Once the target is within attack range (2000 m for cannon), and assuming the target / target marker is within the gate box, the "C" symbol will be displayed. Press cannon fire button and hold it until the burst is completed. Release button and press and hold again if another burst is needed to destroy the target.
5. If the gate on the HUD starts flashing, this indicates that you have reached maximum range of motion for the cannon and firing will cease. Fly the helicopter back on target to attack with cannon again.
6. When the target is destroyed, or the attack prohibited "X" symbol appears, break off the attack.

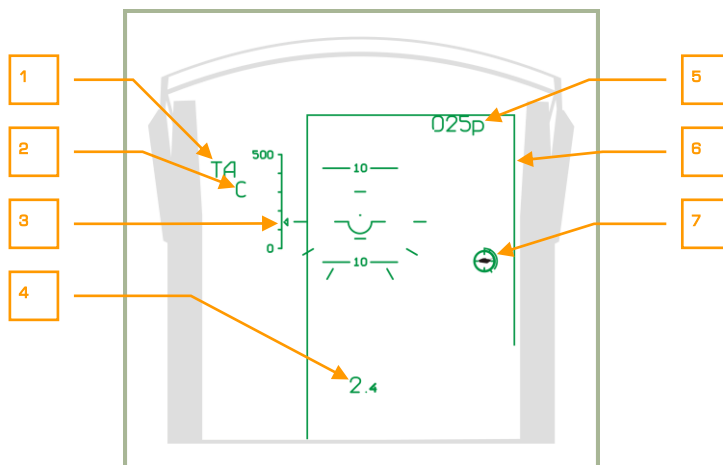

### 7-9: HUD indications when attacking with cannon in auto-track mode

1. "TA" Automatic tracking active (target is tracked)
2. Weapon release authorized "C"
3. Current airspeed
4. Range to target
5. Current altitude
6. «Gate» - cannon motion limits
7. Target marker with range scale inscribed

## Using Rockets or Fixed Cannon with Auto-tracking

To attack a target with the cannon in the fixed position, first set the "ОСН ПЕК" (weapon system mode) selector on the Targeting Mode Control panel to the "НПУ" (fix cannon to boresight) position.

Attacking with fixed cannon or rockets using auto-tracking mode requires the following:

1. Verify that target is being tracked by Shkval.
2. Once the target is within attack range, maneuver the helicopter to aim HUD target marker over the target.
3. Once the "C" symbol appears, press weapon release (rockets) button or fire the cannon according to the selected mode.
4. Break off the attack when the target is destroyed or too close, indicated by the "X" symbol.

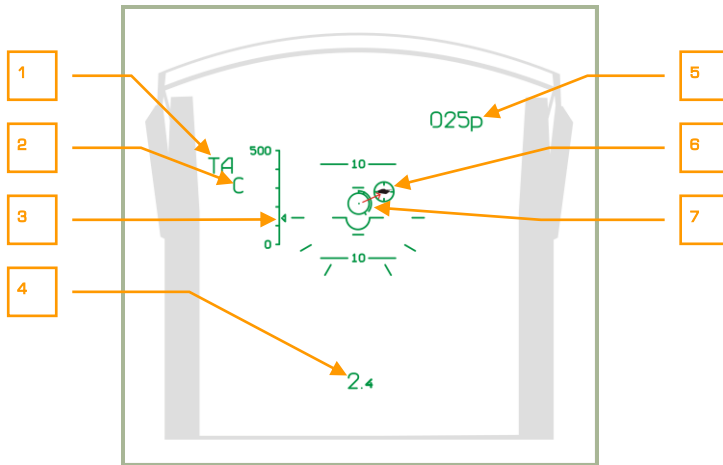

**7-10: HUD indication when attacking with fixed cannon or rockets in auto-track mode**

1. "TA" Auto-tracking is active (target is tracked).
2. Launch authorized "C"
3. Current airspeed
4. Range to target
5. Current altitude
6. Target mark
7. Aiming mark with inscribed range

## FIRING ROCKET OR CANNONS WITHOUT AUTO-TRACKING

Firing rockets or gun pods (cannon) can also be performed without the use of auto-target tracking. Instead, an aiming mark with range-finding can be used, or even without the range finder.

### Firing Rockets or Cannons Using Laser-Rangefinder

Set the **"AC – ПМ"** (Auto-tracking – Gun sight) switch on the Targeting Mode Control panel to the **"ПМ"** (Gun sight) position. The HUD will display the gun sight aiming mark and is aligned with the laser rangefinder axis.

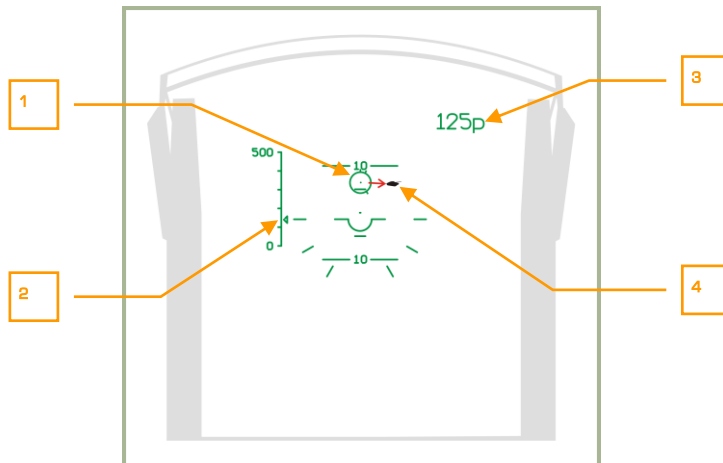

#### 7-11: HUD indications when attacking with fixed gun or rockets without auto-track mode before ranging

1. Gun sight aiming mark
2. Current airspeed
3. Current altitude
4. Target

Maneuver the helicopter to align the aiming mark with the target and then press and hold the **"ABT 3AXB"** (Lock target) button (this turns on laser rangefinder) and you will see the range scale inscribed on the aiming mark. Once range to target is measured, the aiming mark will move to the predicted weapon impact point. The HUD will also display a countdown timer; during the countdown, you cannot turn on the range finder.

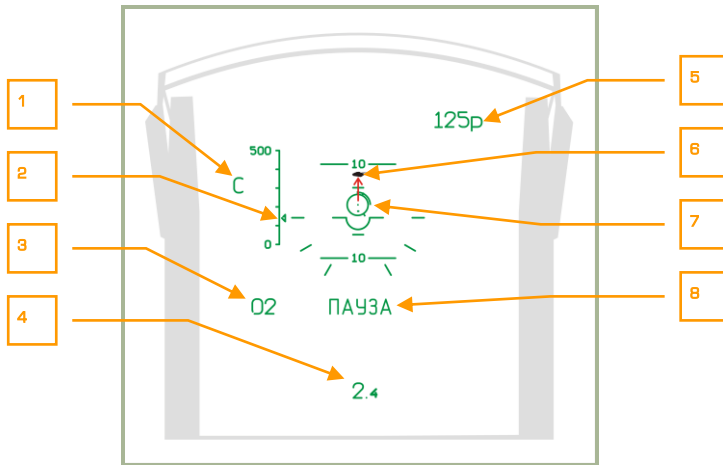

### 7-12: HUD indications when using rockets or fixed cannon without target auto-tracking

1. Launch authorized symbol "C"
2. Current airspeed
3. Countdown timer until rangefinder can be activated again
4. Range to target
5. Current altitude
6. Target
7. Gun sight aiming mark with inscribed range scale
8. "ПАУЗА" (Pause) symbol – cannon activate rangefinder

Perform these steps again to align gun aiming mark with the target, and after the launch authorized symbol appears, press the cannon button or rocket (gun pods) button.

## Employing Rockets or Cannon with the Standby Reticle

After the appropriate weapons system has been selected, set the HUD mode knob to the "СЕТКА" (Reticle) position. Maneuver the helicopter to place the aiming point on the target and then fire weapon. Depending on the range and angle to target, the aiming point will vary along the fixed sight.

Lead aiming considerations:

- When considering wind speed, put in lead opposite to the wind direction.
- When considering target speed, put lead in front on the target's movement direction. The greater the target speed will require more lead.



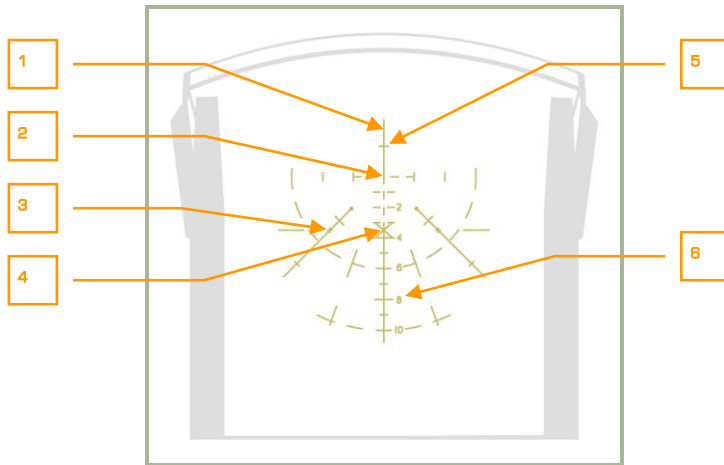

### 7-13: HUD indications using the standby reticle

1. Helicopter's longitudinal axis
2. Helicopter's horizontal axis.
3. Mark according to vertical angle of  $2^\circ$  and course angle of  $3^\circ$ .
4. HUD center (minus  $2^\circ$ )
5. Vertical angle of  $1^\circ$
6. Scale in 10 mils

**Mils** - Abbreviation for milliradian; Bomb/Gun sight settings are expressed in mils, an angular measurement; one degree is equal to 17.45 mils.

## Employing Bombs

To employ bombs from the Ka-50, you must estimate a release point calculation.

When making a bombing run, avoid any banking and side slips, and stay higher than 200 m. When below 200 m, the release of bombs is blocked. There is however no minimum release altitude for the KMGU dispenser.

Taking into account speed and true altitude, you must calculate the release point and then press and hold the release button.

**Note.** The release of sub-munitions from the KMGU dispensers takes place after 1.5 seconds after pressing the weapon release button.



## SPECIAL CONSIDERATIONS WHEN ATTACKING AIR TARGETS

Aiming at an air target can be done when the air target stands out sufficiently against the background. When target range is over 1,500 m it is often best to use Vikhr missiles, otherwise use the cannon. Missile launch and cannon attacks should be done when the target is being auto-tracked. When beginning a target auto-track procedure, make sure that the tracking gate is sized to capture all target elements. When a target's angular velocity is high, maneuver the helicopter to keep it within the HUD's FOV limits.

When attacking air targets with the built-in cannon when in a dive, consider rapidly increasing helicopter speed with a dive angle of around  $-60^\circ$  (speed will increase at about 30 km/h per second). Pitch angles should be kept within allowed limits and exit from the dive should be performed accordingly to avoid excessive helicopter speed on exit.

When attacking an air target with the cannon during a climb, consider the rapid reduction in speed, especially at angles over  $+60^\circ$  (which leads to speed bleeding by 40 km/h per second). Also, keep angles within limits to avoid speed reduction under 50 km/h when exiting.

To use the Vikhr's proximity fuze that will detonate the warhead with a near miss, turn on the **"БЦ"** (Airborne target) button from the Targeting Mode Control Panel.

Depending on the target's aspect (attack hemisphere), it may be necessary to adjust the missile's proximity fuze delay.

If performing a pursuit or side attack, fuze adjustment is not required.

If attacking at high aspect (in the Head-on hemisphere) it is necessary to decrease the fuze delay in order to increase hit probability. From the Targeting Mode Control Panel, press the **"ППС"** (Head-on hemisphere) button to do so.



**8**

**RADIO  
COMMUNICATIONS**

## 8 RADIO COMMUNICATIONS

The simulation supports radio communications with other entities in the virtual world. This includes wingmen, ground crew, and air traffic control.

### RADIO FREQUENCIES

All radio commands are available from the communications menu [\\] and are transmitted and received using the helicopter's radio system. As in real life, to establish communication in the game it is necessary for both communicating parties to be on the same frequency. If this condition is not fulfilled, all transmitted messages will be lost.

The Ka-50 uses the R-800 VHF radio to communicate with other helicopters and ground crew. The R-800 operates at frequencies between 100 and 149 MHz as well as 220 to 400MHz.

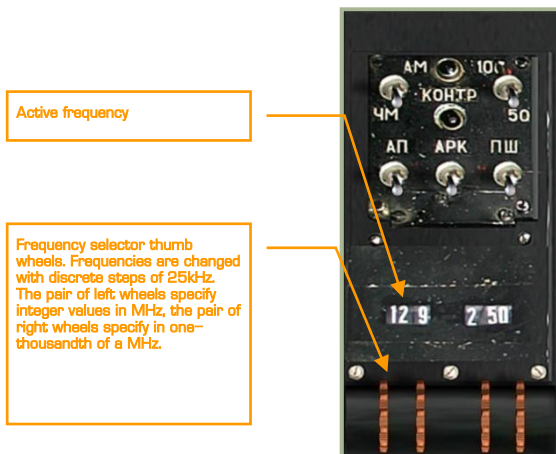

#### 8-1: The R-800 VHF radio

All communications between flight members and air traffic control are performed at a preset frequency of 127.5 MHz by default. Unlike in the real world, you do not need to change frequencies to communicate with different airfields.

Nevertheless, the game allows each airfield and each flight to have a separate frequency. This can be configured by editing the <\\Scripts\World\Airdromes.lua> file for airfield frequencies.

If these frequencies are changed, you will need to set them in the R-800 in order to communicate with other mission entities.

Communications with flight members and ATC are carried out on 127.5 MHz frequency by default. Therefore, you do not need to adjust it.



VHF communications work only when direct line of sight is present. This is true in both real life and the simulation. For a message to be received, a direct line of sight is required between sender and receiver, and the distance should not exceed 150 km. If the receiver is located beyond maximum range, or if there is blocking terrain, the messages will be lost.

Encoded, external data link targeting information is also transmitted by the R-800 and is thus also subject to the same transmission limitations.

For an encoded data link transmission to work properly, each of the four flight members must have their own, unique ID's.

In single-player missions, all flight members have unique ID's that correspond to their status in the formation. In a multi-player game (up to 4 players), players will need to agree upon and assign to themselves unique ID's as well as a common communications frequency. Frequency can be specified in discrete steps of 25 kHz; this allows for up to 9,200 possible frequencies.

Players in a multi-player mission will need to agree upon a communications frequency and set it on their R-800. Additionally, they will need to specify different ID numbers (using the "WHO AM I" knob) in order to transmit target information over the data link.

Erroneous transmissions and inaccurate ABRIS positions will be displayed on the ABRIS if other players join with the same ID's that are on the same frequency.

## COMMAND MENU

The commands menu is selected with the [N] key.

The following sub-menus are available:

[F1] Flight...

[F2] Wingman 2...

[F3] Wingman 3...

[F4] Wingman 4...

[F6] Tower...

[F10] Ground Crew...

"Flight...", "Wingman 2...", "Wingman 3...", "Wingman 4..." allow you to communicate with the entire flight or each wingman separately. "Tower..." is for communications with Air Traffic Control (ATC). "Ground Crew..." is for communications with ground service personnel.

To exit the communications menu, press [F12] or [ESC].

Detailed command descriptions are provided below.



## Flight

To give the command to all members of the flight press:

[\\] Commands → [F1] Flight ...

The following flight sub-menu will then become available:

[F1] – Engage...

[F2] – Go Pincer...

[F3] – Go To...

[F4] – Cover Me

[F5] – Jettison Weapons

[F6] – Go Formation...

[F7] – Rejoin Formation

## Wingmen

To give commands to individual wingmen:

[\\]Commands → [F2] Wingman 2 ...

[\\]Commands → [F3] Wingman 3 ...

[\\]Commands → [F4] Wingman 4 ...

You (flight lead) will then have the following commands available for each wingman:

[F1] – Engage...

[F2] – Go Pincer...

[F3] – Go To...

[F4] – Cover Me

[F5] – Jettison Weapons

[F6] – Reconnaissance ...

[F8] – Hold Position

## Engage

The "Engage" submenu has commands to specify targeting for wingmen. These can be given to each wingman individually or to the entire flight.

To give the commands to the whole flight, the following key sequence needs to be pressed:

[\<] Commands → [F1] Flight → [F1] Engage...

To give commands to individual wingmen:

[\<]Commands → [F2] Wingman 2 → [F1] Engage...

[\<]Commands → [F3] Wingman 3 → [F1] Engage...

[\<]Commands → [F4] Wingman 4 → [F1] Engage...

You (flight lead) will then have the following commands available:

[F1] – My Target

[F2] – My Enemy

[F3] – Bandits

[F4] – Air Defenses

[F5] – Ground Targets

[F7] – Mission and Rejoin

[F8] – Mission and RTB

[F9] – Data link Target

[F10] – Data link Targets

### Engage My Target

Wingmen will stop their current task and will attack your target. You may set the target using padlock or by locking it with the Shkval.

### Engage My Enemy

Wingmen will attack the target (aircraft or air defense vehicle) that is a threat to you.

Wingmen will analyze the situation and attack the target that is of the highest threat.

### Engage Bandits

Wingmen will search and engage enemy helicopters that are within their detection range.

The detection range depends on weather, time of day conditions, and the wingman's skill level. If no target is detected, the wingmen will report back accordingly.



## Engage Air Defenses

Wingmen will search for and attack enemy air defenses.

If wingmen have ATGMs they will attack SAM sites, both stationary and mobile, including search radars and launch vehicles.

If wingmen do not carry ATGMs they will not attack SAM sites but may attack Anti-Aircraft Artillery (AAA) targets. These include Shilka, Vulcan, ZU-23, etc.

Man-Portable Air Defense System (MANPADS) SAM's will only be attacked when their missile launch is detected.

## Engage Ground Targets

"Engage Ground Targets" instructs wingmen to stop their current task and start searching for and attacking ground targets.

Ground targets are all moving and stationary enemy vehicles.

Once the order is received, the wingmen will attack targets based on their threat priority. Air defense systems have the highest priority while unarmed vehicles have the lowest priority.

If wingmen are not carrying ATGMs or rockets, they will attack targets with their cannons and machine guns but only if targets are not protected by enemy air defenses.

## Mission and Rejoin

"Mission and Rejoin" instructs wingmen to attack targets that are mission goals and then rejoin formation.

## Mission and RTB

"Mission and RTB" instructs wingmen to carry out mission tasks and then return to base.

## Engage Datalink Target

The "Engage Datalink Target" group of commands instructs wingmen to attack targets assigned through the datalink. These commands can be assigned to the flight or individual wingmen.

To give commands to the entire flight, the following key sequence needs to be pressed:

[N] Commands → [F1] Flight → [F1] Engage → [F9] Datalink Target

To give commands to individual wingmen:

[N] Commands → [F2] Wingman 2 → [F1] Engage → [F9] Datalink Target

[N] Commands → [F3] Wingman 3 → [F1] Engage → [F9] Datalink Target

[N] Commands → [F4] Wingman 4 → [F1] Engage → [F9] Datalink Target

This in turn will give you (flight lead) the following command options:

[F1] – Target



[F2] – Targets

[F3] – Target by Type

[F4] – Targets by Type

1. "Datalink Target – Target" instructs wingmen to stop their current tasks and attack a target or group of targets nearest to the datalinked target location.
2. "Datalink Target – Targets" instructs wingmen to stop their current tasks and attack all targets within a 3km radius of the datalinked target location.
3. "Datalink Target – Target by Type" instructs wingmen to stop their current tasks and attack a target or group of targets of a specified type (SAMs, Vehicles, or Other) nearest to the datalinked target location.
4. "Datalink Target – Targets by Type" instructs wingmen to stop their current tasks and attack all targets of a specified type (SAMs, Vehicles, or Other) within a 3 km radius of the datalinked target location.

When the engagement is over the wingmen will automatically rejoin formation.

## Target Detection

All aircraft in the simulation have an advanced target detection model that takes into account the following conditions:

- Cockpit geometry. Targets will only be detected in sectors that are visible from the cockpit. For example: the Su-25 and Ka-50 have a smaller detection sector in the rear hemisphere due to cockpit design compared to aircraft like the A-10 and Su-27.
- Target's angular size. The closer and larger a target is will result in a shorter time it will take to detect the target. For example: a large ship that is far away may be detected just as quickly as a tank nearby.
- Lighting conditions. During daylight hours, a target will be detected faster than during the night, dawn, and dusk. Targets will not be visually detected at night.
- Terrain and ground object blocking. If a target is blocked by a hill, mountain, building, or trees, it will not be detected.
- Fog. The thicker the fog the harder it is to detect a target. Targets will not be detected visually in thick fog.
- Full cloud cover. If a target is below the cloud base (and the aircraft is above it), the target will not be detected visually.
- Group of targets. If there are other targets in the vicinity they all will be detected faster than one lone target.

Maximum detection range for an object the size of a tank is 7 km. The range of immediate detection is around 2.5 km. The closer the target, the shorter time to detect it.

## Pincer

This maneuver is used to attack a target from multiple directions. In the simulation there are two commands that can be used with a flight of helicopters: "Go Pincer Right" and "Go Pincer Left".

A pincer maneuver should be initiated when reaching the target area ingress point and still out of range of the enemy air defenses. Generally, this maneuver should be started when the target area is still out 8-15 km away when the ingress is performed at low and very low altitudes.

It may be beneficial to attack a target from three sides at once. For example: wingman 3 could be instructed to "Go Pincer Right", wingman 4 instructed to "Go Pincer Left", and you with wingman 2 attack the target head-on.

Once the order is given, you should reduce speed and wait until your wingmen take their new positions. Only then should the engage orders be given.

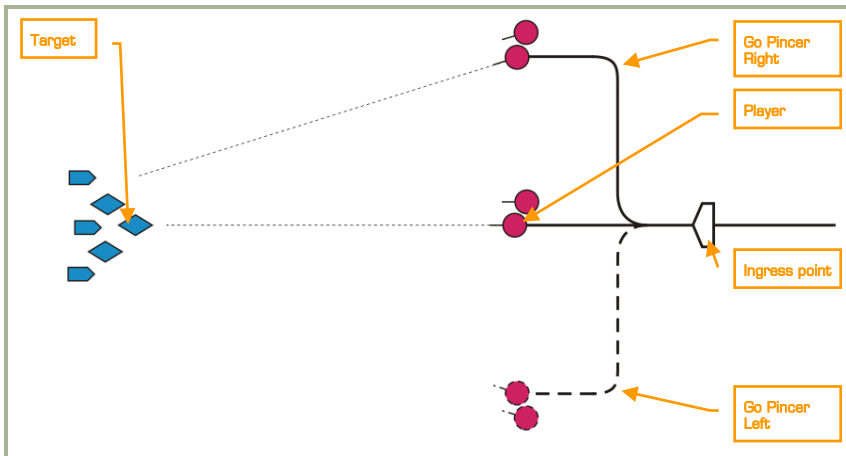

### 8-2: Pincer maneuver

To execute a pincer maneuver, order all members of the flight by using the communications commands menu with the following key sequences:

[N] Commands → [F1] Flight → [F2] Go Pincer...

To give this order to individual wingmen, press:

[N] Commands → [F2] Wingman 2 → [F2] Go Pincer...

[N] Commands → [F3] Wingman 3 → [F2] Go Pincer...

[N] Commands → [F4] Wingman 4 → [F2] Go Pincer...

Then, the following sub-menu will be available:

[F1] – Right

[F2] – Left

### **Go Pincer Right**

“Go Pincer Right” instructs wingman to turn right 90°, fly 3 km from the turn point and then turn left to initial course.

### **Go Pincer Left**

“Go Pincer Left” instructs wingman to turn left 90°, fly 3 km from the turn point and then turn right to initial course.

## **Go To**

This command group is used to direct wingmen to a specific location.

To give the command to all members of the flight press:

[N] Commands → [F1] Flight → [F3] Go To...

To give the command to a specific wingman, press:

[N] Commands → [F2] Wingman 2 → [F3] Go To...

[N] Commands → [F3] Wingman 3 → [F3] Go To...

[N] Commands → [F4] Wingman 4 → [F3] Go To...

The following sub-menu will then become available:

[F1] – Return to Base

[F2] – Route

[F3] – Data link Point

### **Return to Base**

Wingman will stop their current task and will fly directly and land at the assigned airfield.

### **Route**

Wingman will return to the predefined flight plan and then proceed to the airfield and land.

### **Data link Point**

Wingman will proceed to the location specified via the Data Link transmission. Once the location has been reached, he will hover and await further orders.

## **Cover Me**

The “Cover Me” command is used when enemy aircraft has become a threat to your helicopter.



Once a wingman receives it, they stop their current tasks and provide cover for you. If they detect an enemy aircraft, they will attack it without need of further orders.

To give this command to the flight, press:

[N] Commands → [F1] Flight → [F4] Cover Me

To give it to individual wingmen, press:

[N] Commands → [F2] Wingman 2 → [F4] Cover Me

[N] Commands → [F3] Wingman 3 → [F4] Cover Me

[N] Commands → [F4] Wingman 4 → [F4] Cover Me

## Jettison Weapons

“Jettison Weapons” instructs wingmen to jettison all weapons from external hardpoints.

This reduces helicopter weight and drag, and increases lift power and flight range.

Weapons jettison is performed in emergency situations. For example: when there is a sudden air defense threat that requires immediate evasive maneuvers, engine damage, or low fuel situations.

When all weapons are jettisoned, the wingmen have virtually no ability to continue their mission because the only weapon remaining will be their cannon.

To give this order to all flight members, press:

[N] Commands → [F1] Flight → [F5] Jettison Weapons

To give this order to an individual wingman, press:

[N] Commands → [F2] Wingman 2 → [F5] Jettison Weapons

[N] Commands → [F3] Wingman 3 → [F5] Jettison Weapons

[N] Commands → [F4] Wingman 4 → [F5] Jettison Weapons

## Formations

Formations are tactical flight patterns that can be used at different stages of flight and combat.

Different flight formations need to be chosen depending on mission task, onboard weapons, expected air defenses, and wingmen skill. There are three components to the formation: distance, interval, and altitude. Depending on these parameters, formations can be tight and spread out. In tight formation, flight members fly at minimum-allowed distances and intervals from each other. In spread formation, intervals and distances are extended but within visual limits.

To give formation orders to the flight, press:

[N] Commands → [F1] Flight → [F6] Go Formations...

This will display a sub-menu with the following commands:

- [F1] – Heavy
- [F2] – Echelon
- [F3] – Spread
- [F4] – Trail
- [F5] – Overwatch
- [F6] – Left
- [F7] – Right
- [F8] – Tight
- [F9] – Cruise
- [F10] – Combat

Using these commands, you can form each of the three flight formations: Heavy, Echelon, and Spread, in left or right configuration, and in three levels of density: Tight, Cruise, and Combat.

For Trail formation player can select Tight, Cruise, or Combat patterns.

### “Heavy” formation

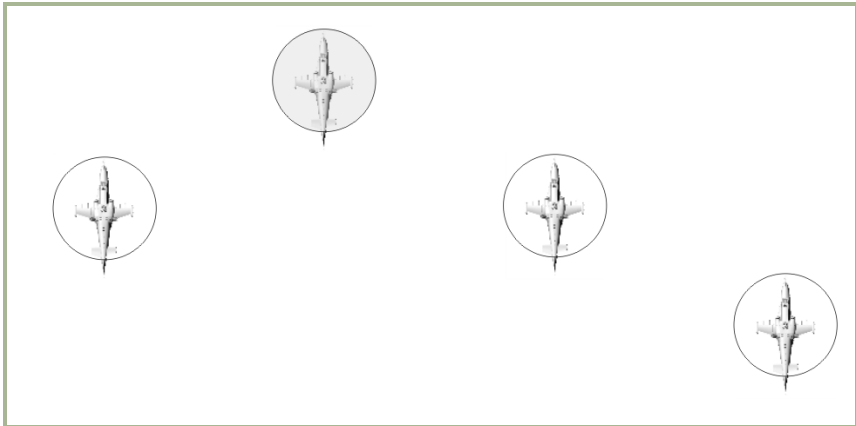

#### 8-3: “Right Heavy” formation

“Right Heavy” formation is used as the default formation.

Flight lead (player) is at the head of the formation with wingman 2 staggered back to the left. To the right are wingman 3 and 4 staggered back.

## “Echelon” formation

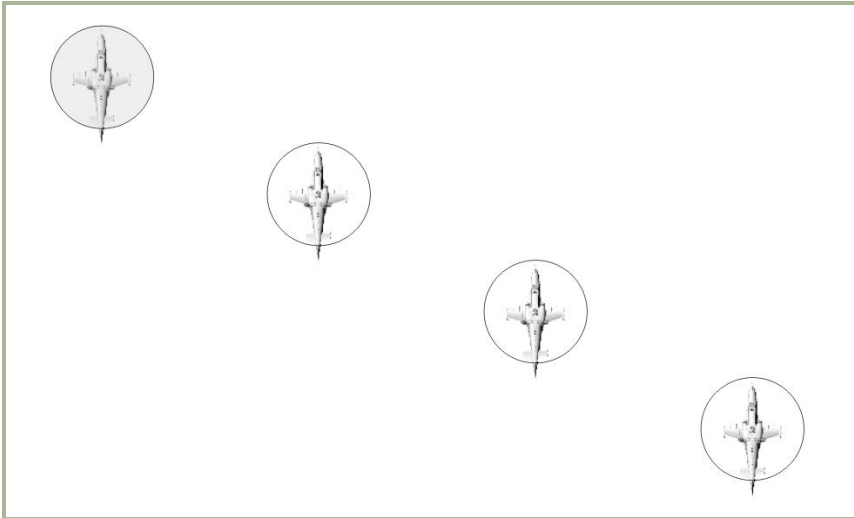

### 8-4: “Right Echelon” formation

In the “Right Echelon” formation, flight lead is located on the left at the forefront and to the right are wingmen 2, 3 and 4. Each wingman is staggered behind the one ahead of it.

The Echelon formation is used for fast and concealed flight. It provides good observation, freedom for maneuvering, and defense of the aircraft in the front.

## “Spread” formation

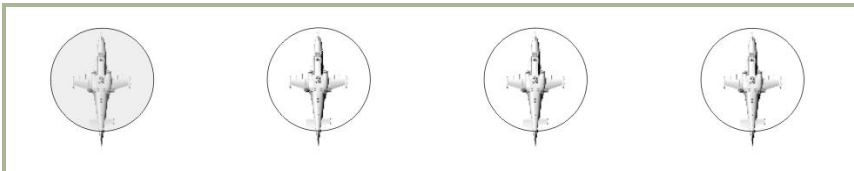

### 8-5: “Right spread” formation

In the “Right Spread” formation, you are located on the left side of the formation with wingman 2, 3, and 4 to the right. All wingmen are abreast of each other.

“Spread” formation is used in combat when freedom of maneuverability and concentrated firepower are required. Observation and fire sectors overlap between flight members and this allows the flight to mutually focus on higher priority targets.

## “Trail” formation

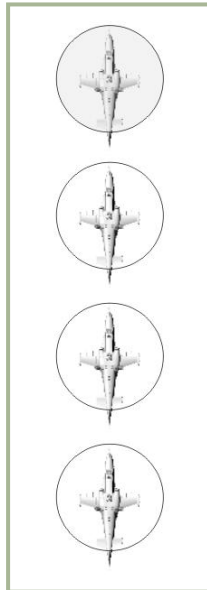

### 8-6: “Trail” formation

In the “Trail” formation, you are at the forefront and the wingmen are in line behind.

“Trail” formation is used when flying through mountainous terrain to reduce the risk of ground collision for wingmen.

### Overwatch

With the “Overwatch” command flight lead (player) can assign one wingman as the observer. The wingman will then fall back 1,500 m and follow the flight.

This will provide him with good view of the rest of the flight and the battlefield and warn the group of any threats.

### Left of Right formation types

“Heavy”, “Echelon”, and “Spread” formations can be setup to the left or to the right of you.

By default, the “Right” formation type is used in the simulation.

### Formation density

As in real life, formations can be tight or spread out.



- **Tight.** Helicopters are positioned within minimum allowed distances and intervals. The distance between aircraft is around 50 m.
- **Cruise.** Used for concealed flight along route. Distance between helicopters is around 100 m.
- **Combat.** Used in combat to allow freedom of movement and weapons employment. Distance between helicopters is around 200 m.

## Rejoin

After contact with the enemy, the formation often falls apart and wingmen perform separate attacks and evasive actions. When the formation needs to be restored, you can issue the "Rejoin" command.

[N] Commands → [F1] Flight → [F7] Rejoin

Once all wingmen receive the order and confirm it, they will stop their current tasks and return to the set formation. When each wingman is back in their formation position he acknowledges it over the radio.

## Hold Position

The "Hold Position" command instructs wingmen to stop their current tasks and initiate a hover at low altitude and wait for further orders.

To give this command to the flight, press:

[N] Commands → [F1] Flight → [F8] Hold Position

To give this command to individual wingmen, press:

[N] Commands → [F2] Wingman 2 → [F8] Hold Position

[N] Commands → [F3] Wingman 3 → [F8] Hold Position

[N] Commands → [F4] Wingman 4 → [F8] Hold Position

## Reconnaissance

Reconnaissance is required when there is little or no information about mission targets in the assigned target area (kill box). Rather than blindly enter a target area and face unseen enemy air defenses, it is wise to first recon the area before committing to the attack. Charging into an attack without proper recon is a fast way to get shot down.

As flight lead (player), you have commands at your disposal to perform reconnaissance with your wingmen. All orders are given individually to wingmen.

Reconnaissance is performed by flying at a specified heading for a specified distance, or flying to a particular location specified through the external targeting system data link. When the order is received, the recon helicopter proceeds at low altitude and scans the terrain using the Shkval. Scanning is performed within  $\pm 35^\circ$  of the helicopter's longitudinal axis. When an enemy is detected, its type and location are transmitted to you using the external targeting system data link.



When the recon destination is reached, the wingman informs you and returns to formation.

Target detection range depends on each wingman's experience level.

- Excellent – detects targets out to 8 km.
- High and Good – detects targets out to 6 km.
- Average – detects targets out to 4 km.

Thus the less experienced the wingman is, the greater the chance that certain targets will go undetected.

Just as in real life, reconnaissance does not guarantee that all targets will be detected.

To give the reconnaissance order to a wingman, press:

[\] Commands → [F2] Wingman 2 → [F8] Reconnaissance

[\] Commands → [F3] Wingman 3 → [F8] Reconnaissance

[\] Commands → [F4] Wingman 4 → [F8] Reconnaissance

This will display a submenu that allows you to specify reconnaissance depth:

[F1] – In Depth 1 km

[F2] – In Depth 2 km

[F3] – In Depth 3 km

[F4] – In Depth 5 km

[F5] – In Depth 8 km

[F6] – In Depth 10 km

[F7] – To Data link Point

### **Reconnaissance to Bearing and Depth**

After the order is received, the wingman will fly in the direction that you are facing (at the time the order is given) to the specified depth (1, 2, 3, 5, 8, 10 km).

### **Reconnaissance to Data Link Point**

Prior to sending this message, you must first select the desired PVI Target Point from the PVI-800 control panel. Once selected and blinking on the ARIS display, select the wingman number from the PRTz Data Link Control Panel and then press the Send button. You may now issue the radio command and the selected wingman will proceed to the location specified via the Data Link transmission. Once the location has been reached, he will hover and await further orders.

## Air Traffic Control

The Air Traffic Control (ATC) menu group contains commands for interaction with airfield traffic controllers and includes operations for start-up, taxiing, takeoff, and landing procedures.

To bring up this submenu press:

[\**\**] Commands → [F6] Tower...

This will display the following commands:

[F1] – Request Start-Up

[F2] – Request Taxi to Runway

[F3] – Request Hover Check

[F4] – Request Takeoff

[F5] – Inbound

[F6] – Request Landing

[F7] – Request Azimuth

### **Request Start Up**

You ask the tower for permission to start up the engines. If the weather does not preclude this, permission is given. Permissible conditions include a wind speed that does not exceed 20 m/s for head-on wind and a 10 m/s for side or tail-wind.

### **Request Taxi to Runway**

You ask permission to taxi. If the weather does not preclude this, permission is given. Permissible conditions include a wind speed that does not exceed 20 m/s for head-on wind and a 10 m/s for side or tail-wind.

### **Request to Hover Check**

You ask permission to do a hover check. If the weather does not preclude takeoff the permission is given. Permissible condition is wind speed that does not exceed 10 m/s in any direction.

### **Request Take Off**

You ask for takeoff permission. If the weather does not preclude this and there is no other aircraft in the air nearby, permission is given. Permissible conditions include a wind speed that does not exceed 10 m/s in any direction.

### **Inbound**

You ask the tower for information about landing at the airfield. The tower replies with heading (in degrees), distance, QFE (air pressure at airfield elevation) and recommends the pilot to assume the pattern altitude. This altitude is usually specific for each airfield;

however it can be assumed to be 300 m by default. FARPs will illuminate the their landing pad at night after this message is sent.

## Request Landing

When you are within 5 km of the airfield you can ask for permission to land. If the runway is free, the tower gives permission along with a landing course, wind speed, and direction on ground. If the runway or landing pad is occupied, the permission is denied and you will be instructed to go around. Once the landing area is free, the tower will provide permission, without the need to request it again.

If you have not asked for landing permission, the tower informs you about landing conditions when you are within 1 km of the runway or other landing area.

## Request Azimuth

The "I'm Lost" request is sent to an automatic radio beacon at the air base when an aircraft loses situational awareness in flight.

In real life, this request is sent when navigation equipment has failed, during inclement weather, or at night. The request is sent on a specific frequency of 130.0 MHz. Once received, the air controller replies with the heading information to the airfield.

This is modeled the same way in the simulation. If you lose situational awareness, you can tune the R-800 radio to 130.0 MHz and send an "I'm Lost" request. The heading to the nearest airfield or landing area will then be sent. To reach it, you need to change the helicopter's heading to the specified value.

Before sending an "I'm Lost" request, you need to tune the R-800 to 130.0MHz. Once a reply is received, you will need to change the frequency back to the airfield's predefined frequency (default 127.5 MHz) in order to communicate with the control tower.

## Ground Crew

This menu group contains commands to communicate with the ground crew. The ground crew can change weapon payloads, refuel the aircraft, provide electrical power supply, change helmet devices, and connect the APU to the turbo gear.

In real life, all this work is performed by the ground crew. The communication is done through the pilot's and ground crew's telephone headsets when the Comms knob is set to "НОП".



Knob position for communicating with ground crew.

### 8-7: Radio panel



When the helicopter is "cold", communication is done by voice through the open door.

As in real life, there are two communication methods with the ground crew:

- Through the telephone headset device when the radio knob is set properly and when the "ABCK" switch is set to "ON" on the side panel.
- Through normal voice when the helicopter is "cold" and the door is open. This assumes that the engines, APU, and rotors are off.

When at airfields, communication with ground crew is only possible on the concrete areas. At Forward Arming and Refueling Points (FARPS), the entire landing pad is a valid area.

When any command is given, the crew replies with a "Copy" to acknowledge that the order was received and understood. If the acknowledgement is not received, you should assume the command was not received. In such a case it is advisable to check the radio control knob, that the door is open, or that there is no noise from the engines, APU, or rotors.

The time to complete the order is usually one to three minutes.

To bring up the ground crew commands menu press:

[\\] Commands → [F10] Ground Crew ...

This will display the following options:

[F1] – Weapons Reload

[F2] – Refuel

[F3] – Helmet Device

[F4] – Ground Electric Power

[F5] – Turbo gear

## Weapons Reload

To perform a weapons reload press:

[\\] Commands → [F10] Ground Crew → [F1] Weapons Reload ...

This will display the following submenu:

[F1] – Ferry

[F2] – Deep Strike

[F3] – Anti-tank

[F4] – CAS

[F5] – Lightweight variants

[F6] – By Flight Plan

## Ferry

This configuration is used for distant relocations or long flights. It is optimized for maximum flight range with few if any weapons onboard.

- [F1] – 2 Fuel Tanks (2 Fuel Tanks 440 kg)
- [F2] – 4 Fuel Tanks (4 Fuel Tanks 440 kg)
- [F3] – 2 Fuel Tanks, 2A42 (2 Fuel Tanks 440 kg and cannon)
- [F4] – 4 Fuel Tanks, 2A42 (4 Fuel Tanks 440 kg and cannon)
- [F5] – 2A42 (internal gun)
- [F6] – Empty

## Deep Strike

This configuration is used to perform just that – deep strikes. It has two external tanks on a pair of hardpoints and weapons on the other pair.

- [F1] – 2 Fuel Tanks; 12 ATGM; 2A42 (2 Fuel Tanks 440 kg, 12 ATGM “Vikhr”, cannon)
- [F2] – 2 Fuel Tanks; 2 B8; 2A42 (2 Fuel Tanks 440 kg, 2 S-8 rocket launchers, cannon)
- [F3] – 2 Fuel Tanks; 2 UB-13; 2A42 (2 Fuel Tanks 440 kg, 2 S-13 rocket launchers, cannon)
- [F4] – 2 Fuel Tanks; 2 UPK-23; 2A42 (2 Fuel Tanks 440 kg, 2 UPK-23 gunpods, cannon)
- [F5] – 2 Fuel Tanks; 2 KMGU (Anti material); 2A42 (2 Fuel Tanks 440 kg, 2 KMGU with anti material bomblets, cannon)
- [F6] – 2 Fuel Tanks; 2 KMGU (Anti tank); 2A42 (2 Fuel Tanks 440 kg, 2 KMGU with anti tanks bomblets, cannon)
- [F7] – 2 Fuel Tanks; 2 FAB-250; 2A42 (2 Fuel Tanks 440 kg, 2 FAB-250 bombs, cannon)
- [F8] – 2 Fuel Tanks; 2 FAB-500; 2A42 (2 Fuel Tanks 440 kg, 2 FAB-500 bombs, cannon)

## Anti tank

This configuration is best suited for anti-tank missions.

- [F1] – 12 ATGM; 2 B8; 2A42 (12 ATGM “Vikhr”, 2 S-8 rocket launchers, cannon)
- [F2] – 12 ATGM; 2 UB-13; 2A42 (12 ATGM “Vikhr”, 2 S-13 rocket launchers, cannon)
- [F3] – 12 ATGM; 2 UPK-23; 2A42 (12 ATGM “Vikhr”, 2 UPK-23 gunpods, cannon)
- [F4] – 12 ATGM; 2 KMGU (Anti tank); 2A42 (12 ATGM “Vikhr”, 2 KMGU with anti tanks bomblets, cannon)

## CAS

This configuration is best suited for close air support of ground troops on the battlefield. Intended targets include armored and unarmored vehicles, artillery, and infantry.



- [F1] – 4 B8; 2A42 (4 S-8 rocket launchers, cannon)
- [F2] – 4 UB-13; 2A42 (4 S-13 rocket launchers, cannon)
- [F3] – 4 UPK-23; 2A42 (4 UPK-23 gunpods, cannon)
- [F4] – 4 KMGU (Anti material); 2A42 (4 KMGU with anti material bomblets, cannon)
- [F5] – 4 KMGU (Anti tank); 2A42 (4 KMGU with anti tanks bomblets, cannon)
- [F6] – 4 FAB-250; 2A42 (4 FAB-250 bombs, cannon)
- [F7] – 4 FAB-500; 2A42 (4 FAB-500 bombs, cannon)

### **Lightweight variants**

This configuration is optimized for when outside temperature is high or when operating from high-mountain areas.

In these conditions, engine power output is reduced, thus there is a need to limit the helicopter's overall weight to enable vertical flight.

- [F1] – 6 ATGM; 2A42 (4 ATGM "Vikhr", cannon)
- [F2] – 12 ATGM; 2A42 (12 ATGM "Vikhr", cannon)
- [F3] – 2 B8; 2A42 (2 S-8 rocket launchers, cannon)
- [F4] – 2 UB-13; 2A42 (2 S-13 rocket launchers, cannon)
- [F5] – 2 UPK-23; 2A42 (2 UPK-23 gunpods, cannon)
- [F6] – 2 KMGU (Anti-material); 2A42 (2 KMFY KMGU with anti material bomblets, cannon)
- [F7] – 2 KMGU (Anti-tank); 2A42 (2 KMGU with anti tanks bomblets, cannon)
- [F8] – 2 FAB-250; 2A42 (2 FAB-250, cannon)
- [F9] – 2 FAB-500; 2A42 (2 FAB-500, cannon)

### **By Flight Plan**

This commands the ground crew to equip the helicopter with weapons as they were configured in the mission editor.

## **Refuel**

To bring up the Refuel menu press:

[V] Commands → [F10] Ground Crew → [F2] Refuel ...

This will display the following options:

- [F1] – 25%
- [F2] – 50%
- [F3] – Maximum Combat Weight (10,800 kg)



[F4] – Maximum Ferry Weight (11,900 kg)

### **Fuel 25%**

Internal fuel tanks are filled up to 25% (363 kg) of capacity.

### **Fuel 50%**

Internal fuel tanks are filled up to 50% (725 kg) of capacity.

### **Maximum Combat Weight**

Maximum combat takeoff weight is limited to 10,800 kg based on the airframe stress limits.

After receiving this order, the ground crew calculates the maximum fuel quantity that will not put the helicopter's weight (including loaded weapons) over 10,800 kg.

#### **Example 1:**

Here are the calculations for maximum fuel when carrying 12 Vikhr missiles and a full cannon ammo load.

Weight of the helicopter itself with a pair of Vikhr hardpoints – 8,140 kg

12 Vikhr missiles – 720 kg

460 cannon rounds – 460 kg

Maximum fuel quantity in this configuration:

$10,800 - 8140 - 720 - 460 = 1,480$  kg

Internal fuel tanks have the maximum capacity of 1,450 kg.

#### **Example 2:**

Here are the calculations for maximum fuel when carrying 12 Vikhr missiles, S-8 rocket pods, and a full cannon ammo load.

Weight of helicopter itself with a pair of Vikhr hardpoints and S-8 hardpoints – 8,200 kg

12 Vikhr missiles – 720 kg

2 S-8 rocket blocks (B-8) – 672 kg

460 cannon rounds – 460 kg

Maximum fuel quantity in this configuration:

$10,800 - 8200 - 720 - 672 - 460 = 748$  kg

748 kg corresponds to internal fuel tanks filled to 52% capacity.

### **Maximum Ferry Weight**

The maximum Ferry weight is limited to 11,900 kg based on airframe stress limits.

After receiving this order, the ground crew calculates the maximum fuel quantity that will not put the helicopter's weight (including installed weapons) over 11,900 kg.

Note that a helicopter that weighs more than 10,800 kg has a stricter G-limit of 1.5 due to airframe stress limits.

**Example 1:**

Here are the calculations for maximum ferry weight with four external fuel tanks.

Helicopter's weight including 4 fuel tanks and 4 fuel tank racks – 8,350 kg

Maximum fuel capacity:  
 $11,900 - 8,350 = 3,550$  kg

Internal and external tanks can hold a total of 3,210 kg at 100% capacity.

**Example 2:**

Here are the calculations for maximum ferry weight with four external fuel tanks and a full cannon ammo load.

Helicopter's weight including 4 fuel tanks and 4 fuel tank racks – 8,350 kg

460 cannon rounds – 460 kg

Maximum fuel capacity in this configuration:  
 $11,900 - 8,350 - 460 = 3,090$  kg

This corresponds to 96% capacity of external and internal fuel tanks. Thus, internal fuel tanks will be at 100% (1,450 kg) and external tanks will contain 410 kg each.

## Helmet Device

The Ka-50 pilot can use two helmet devices: Helmet Mounted Sight (HMS) targeting system and Night Vision Goggles (NVG).

The HMS system, designated Shel-ZUM, is used to determine angular coordinates of line-of-sight of tracked target (tracking is done by moving your head) and transmitting this information to the Shkval targeting system.

**8-8: Helmet Mounted Sight (HMS) targeting system**

OVN-1 "Skosok" night vision goggles are used in low-light conditions for takeoff, flight at low altitudes, target detection, and landing on unlit areas.





### 8-9: Night vision goggles (NVG)

Depending on the mission and flight conditions, you may wish the ground crew to replace the helmet device.

Standard equipment is the HMS targeting system; however, in low light conditions it may be preferable to fly with the night vision goggles.

To bring up the helmet device menu press:

[N] Commands → [F10] Ground Crew → [F3] Helmet Device ...

This will bring the submenu:

[F1] – HMS

[F2] – NVG

## Ground Electric Power

During normal operations, a helicopter needs to be started using a mobile power supply at the airfield or FARP. However, start-up from onboard batteries is possible in emergencies or when operating from unprepared locations where an external power supply is not available.



### 8-10: Mobile electrical power supply

To bring up the menu for external power supply control press:

[\\] Commands → [F10] Ground Crew → [F4] Ground Electric Power ...

This will display the following commands:

[F1] – On

[F2] – Off

When a helicopter is starting from a “cold” state at the beginning of a mission, it is already connected to external power supply by default. Therefore, there is no need to explicitly request to connect to it.

You will need to request this procedure when landing during the mission and the engines are turned off. In this case, the command needs to be issued when the cockpit door is open.

This equipment is available at all airfields and FARPS.

## Turbo Gear

Turbo gear allows the testing of helicopter subsystems without the need to have the engines running. This gear operates from compressed air that is supplied by APU power and it powers the AC generator and hydraulics pump.

On the real Ka-50, turbo gear is activated by the ground crew by setting the appropriate controls on the helicopter’s main gearbox. This in turn displays “**МУФТА ОТКЛ**” in the cockpit and disables engine start.

To bring up the menu for turbo gear control press:

[\\] Commands → [F10] Ground Crew → [F5] Turbo gear...

The available options are:

[F1] – On

[F2] – Off

Turbo gear is OFF by default.

To connect turbo gear to the main gearbox and start it:

1. Order the ground crew to connect turbo gear to the main gearbox and confirm it by the “**МУФТА ОТКЛ**” indicator.  
[\\] Commands → [F10] Ground Crew → [F5] Turbogear → [F1] On
2. Launch and warm up the APU as required.
3. Turn the knob (Engine selector: APU-left engine-right engine-turbo gear) [E] to “**ТУРБОПРИВОД**” (engines control panel on the left panel).
4. Turn on the generators and other subsystems as needed.

Perform the above steps in reverse order to turn off turbo gear before starting main engines.

## Ground Equipment Requirements

At Forward Arming and Refueling Points (FARP)s, ground equipment resources are tracked to determine the level of support that can be provided to the player. This can include electrical power, radio communications, fuel, and weapons for both AI helicopters and the player.

The ground equipment units must be placed within a 150 meters radius from the center of the FARP (it is circumcircle around corners of the FARP). The units required vary between eastern and western forces:

Eastern forces:

1. CP SKP-11 command post, FARP command post for radio communications
2. GPU APA-50 or GPU APA-80 for electrical power
3. ATMZ-5, ATZ-10, Transport URAL-375 or FARP Fuel Depot for refueling
4. URAL-375 transport or FARP Ammo Dump for rearming

Western forces:

1. M1025 HMMWV APC for radio communications
2. M818 transport for electrical power
3. M978 HEMTT tanker for refueling
4. M818 transport for rearming

If an above unit is absent or destroyed, the assigned resource will be unavailable.

Note: If a FARP is attacked and all units are destroyed, you may wish to set up a trigger to move new units within 150 meters of the destroyed base to provide support functions. For airfields, the above vehicles are not required, but if the control tower is destroyed, radio communications will not resume until a M1025 or CP SKP-11 command is brought to the area.



## COMMANDS AND MESSAGES

All radio communications use the following format:

**Callsign «to whom», callsign «from who», message.**

- Callsign to whom – designates the message receiver.
- Callsign from who – designates message sender.
- Message – the actual information message.

Example 1:

**Maikop, 251, distance 5, visual to runway, gear is down, ready for landing.**

This message is sent to the control tower at Maikop airfield and the callsign of the aircraft is 251. The pilot informs the tower that he is 5 km from the runway, has a visual on the runway, has his landing gear down, and is ready for landing.

Example 2:

**Two, SAM launch, 3 o'clock, engaging defensive.**

All internal-flight messages are addressed to the flight lead. Therefore, the sender callsign ("to whom") is omitted.

In this example, wingman 2 informs that he detected a surface-to-air missile launch at his 3 o'clock and is performing a defensive maneuver to avoid the missile.

The direction is based on the clock hours that became very common among Allied air forces during the Second World War. The principle is simple; the pilot assumes position at the center of the clock. Current flight direction (aircraft nose) is pointing at 12 o'clock, tail is at 6 o'clock, to the right is 3 o'clock, and to the left is 9 o'clock.

"Target 4 o'clock low" means the target is located to the right and slightly behind and is lower than the aircraft.

Radio messages (brevity codes) need to be short and easy to understand.

The following tables describe types of messages and radio commands in the simulation. Depending on the type of message, from two to four key presses (F1-F10) may be required to send a radio message.

- Receiver – this is the message recipient: flight, wingman, control tower, ground crew.
- Command – this is the message type ("Attack", "Takeoff permission" etc.)
- Subcommand – example "Attack my target" or "Echelon formation".
- Response and comments – receiver's response to the message.

## Commands and Messages List

Message Target (Key)	Command (Key)	Sub Command (Key)	Response(s) and comments
(F1) Flight (F2) Wingmen 2 (F3) Wingmen 3 (F4) Wingmen 4	(F1) Engage ...	(F1) My Target	If wingman is capable of carrying out this command, he will respond "(x) Engaging designate target". If wingman is incapable of carrying out command, he will respond, "(x) Negative," or "(x) Unable".
		(F2) My Enemy	If wingman is capable of carrying out this command, he will respond "(x) Copy," "(x) Roger," or "(x) Affirm". If wingman is incapable of carrying out command, he will respond, "(x) Negative," or "(x) Unable".
		(F3) Bandits	If wingman is capable of carrying out this command, he will respond "(x) Engaging bandits". If wingman is incapable of carrying out command, he will respond, "(x) Negative," or "(x) Unable".
		(F4) Air Defenses	If wingman is capable of carrying out this command, he will respond "(x) Engaging air defenses". If wingman is incapable of carrying out command, he will respond, "(x) Negative," or "(x) Unable".
		(F5) Ground Targets	If wingman is capable of carrying out this command, he will respond "(x) Engaging ground targets". If wingman is incapable of carrying out command, he will respond, "(x) Negative," or "(x) Unable".
		(F7) Mission and Rejoin	If wingman is capable of carrying out this command, he will respond "(x) Engaging primary". If wingman is incapable of carrying out command, he will respond, "(x) Negative," or "(x) Unable".
		(F8) Mission and RTB	If wingman is capable of carrying out this command, he will respond "(x) Engaging primary". If wingman is incapable of carrying out command, he will respond, "(x) Negative," or "(x) Unable".
		(F9) Datalink targets...	If wingman is capable of carrying out this command, he will respond "(x) Target assignment received, engaging target". If wingman is incapable of carrying out command, he will respond, "(x) Negative," or "(x) Unable".
		(F1) Right (F2) Left	If wingman is capable of carrying out this command, he will respond "(x) Copy," "(x) Roger," or "(x) Affirm". If wingman is incapable of carrying out command, he will respond, "(x) Negative," or "(x) Unable".
		(F1) Flight (F2) Wingmen 2 (F3) Wingmen 3 (F4) Wingmen 4	(F2) Pincer...
(F2) Route	If wingman is capable of carrying out this command, he will respond "(x) Following to route ". If wingman is incapable of carrying out command, he will respond, "(x) Negative," or "(x) Unable".		
(F3) Data link point	If wingman is capable of carrying out this command, he will respond "(x) Copy," "(x) Roger," or "(x) Affirm". If wingman is incapable of carrying out command, he will respond, "(x) Negative," or "(x) Unable".  After arrived to the point, wingmen report"(x) "Arrived to point, awaiting the further instructions".		
(F4) Hold position	If wingman is capable of carrying out this command, he will respond "(x) Holding position ". If wingman is incapable of carrying out command, he will respond, "(x) Negative," or "(x) Unable".  If wingman is capable of carrying out this command, he will respond "(x) Copy," "(x) Roger," or "(x) Affirm". If wingman is incapable of carrying out command, he will respond, "(x) Negative," or "(x) Unable".		
(F1) Flight (F2) Wingmen 2 (F3) Wingmen 3 (F4) Wingmen 4	(F4) Cover Me	(F1) Heavy	If wingman is capable of carrying out this command, he will respond "(x) Copy," "(x) Roger," or "(x) Affirm". If wingman is incapable of carrying out command, he will respond, "(x) Negative," or "(x) Unable".
		(F5) Jettison Weapons	If wingman is capable of carrying out this command, he will respond "(x) Copy," "(x) Roger," or "(x) Affirm". If wingman is incapable of carrying out command, he will respond, "(x) Negative," or "(x) Unable".
		(F2) Echelon	If wingman is capable of carrying out this command, he will respond "(x) Copy," "(x) Roger," or "(x) Affirm". If wingman is incapable of carrying out command, he will respond, "(x) Negative," or "(x) Unable".
		(F3) Spread	If wingman is capable of carrying out this command, he will respond "(x) Copy," "(x) Roger," or "(x) Affirm". If wingman is incapable of carrying out command, he will respond, "(x) Negative," or "(x) Unable".



			command, he will respond, "(x) Negative," or "(x) Unable".
		(F4) Trail	If wingman is capable of carrying out this command, he will respond "(x) Copy," "(x) Roger," or "(x) Affirm". If wingman is incapable of carrying out command, he will respond, "(x) Negative," or "(x) Unable".
		(F5) Overwatch	If wingman is capable of carrying out this command, he will respond "(x) Copy," "(x) Roger," or "(x) Affirm". If wingman is incapable of carrying out command, he will respond, "(x) Negative," or "(x) Unable".
		(F6) Left	If wingman is capable of carrying out this command, he will respond "(x) Copy," "(x) Roger," or "(x) Affirm". If wingman is incapable of carrying out command, he will respond, "(x) Negative," or "(x) Unable".
		(F7) Right	If wingman is capable of carrying out this command, he will respond "(x) Copy," "(x) Roger," or "(x) Affirm". If wingman is incapable of carrying out command, he will respond, "(x) Negative," or "(x) Unable".
		(F8) Tight	If wingman is capable of carrying out this command, he will respond "(x) Copy," "(x) Roger," or "(x) Affirm". If wingman is incapable of carrying out command, he will respond, "(x) Negative," or "(x) Unable".
		(F9) Cruise	If wingman is capable of carrying out this command, he will respond "(x) Copy," "(x) Roger," or "(x) Affirm". If wingman is incapable of carrying out command, he will respond, "(x) Negative," or "(x) Unable".
		(F10) Combat	If wingman is capable of carrying out this command, he will respond "(x) Copy," "(x) Roger," or "(x) Affirm". If wingman is incapable of carrying out command, he will respond, "(x) Negative," or "(x) Unable".
		(F1) In Dept 1 km (F2) In Dept 2 km (F3) In Dept 3 km (F4) In Dept 5 km (F5) In Dept 8 km (F6) In Dept 10 km (F7) To Data link Point	If wingman is capable of carrying out this command, he will respond "[X] Proceeding to scan mode". If wingman is incapable of carrying out command, he will respond, "(x) Negative," or "(x) Unable".  If wingman detects a target, he will report: "[X] Target detected, bearing YYY, range ZZZ, armor (air defense, vehicle)" while simultaneously providing data transfer via data link.  After the recon is done the wingmen report: "[X] Reconnaissance complete, rejoining formation".  If wingman takes fire or suffers damage during recon, he will report: "[X] Taking damages, aborting task".
(F2) Wingmen 2 (F3) Wingmen 3 (F4) Wingmen 4	(F6) Reconnaissance		If wingman is capable of carrying out this command, he will respond "(x) Copy," "(x) Roger," or "(x) Affirm". If wingman is incapable of carrying out command, he will respond, "(x) Negative," or "(x) Unable".  Since wingmen will take the place in formation he gives a report: "[X] in formation right (left)".
(F1) Flight	(F7) Rejoin		If wingman is capable of carrying out this command, he will respond "(x) Copy," "(x) Roger," or "(x) Affirm". If wingman is incapable of carrying out command, he will respond, "(x) Negative," or "(x) Unable".
(F1) Flight (F2) Wingmen 2 (F3) Wingmen 3 (F4) Wingmen 4	(F8) Hold position		If weather conditions do not exceed the limits of the start procedures, Tower responds: "[N], [M], cleared to start-up, wind [ZZZ], speed SSS meters per second".  If weather conditions exceed limits of the start procedure, Tower does not give permission: "[N], [M], negative".
(F6) -Tower...	(F1) Request Engine Start		If weather conditions do not exceed the limits for taxi, Tower responds: "[N], [M], cleared to taxi to runway [ZZZ]".  If weather conditions exceed the limits for taxi, Tower does not give permission: "[N], [M], negative".
	(F2) Request Taxi		If weather conditions do not exceed the limits for takeoff, Tower responds: "[N], [M], You are cleared for hover check, wind [ZZZ], speed SSS meters per second".  If weather conditions exceed limits for takeoff, Tower does not give permission: "[N], [M], negative".
	(F3) Request Hover Check		If weather conditions do not exceed the limits for takeoff, Tower responds: "[N], [M], You are cleared for takeoff, wind [ZZZ], speed [SSS] meters per second".  If weather conditions exceed limits for takeoff, Tower does not give permission: "[N], [M], negative".
	(F4) Request Takeoff		Tower responds: "[N], [M], Fly heading [ZZZ], for [YYY], QFE [PPP.P] millimeters, descend to pattern altitude".
	(F5) Inbound		If a runway or helipad is free, Tower provides permission for landing and reports wind conditions: "[N], [M], Cleared to landing runway [ZZZ], wind [ZZZ] degrees at [SSS] meters per second".  If the runway or helipad is occupied, then Tower responds: "[N], [M], Orbit for spacing". After runway or helipad is available, the Tower provides permission for landing without a player request.  If player does not request landing up to 1 km from runway, the Tower respond: "[N], [M], Runway [ZZZ], wind [ZZZ] degrees at [SSS] meters per

	(F6) Request Landing		second, check landing gear". Automatic Direction Finder operator respond: "[N], [M] your bearing is [ZZZ]".
	(F7) Request Azimuth		Tower will provide azimuth to landing airfield.
(F10) Maintenance...	(F1) Change payload...	(F1) Ferry (F2) Deep Strike (F3) Anti Tank (F4) CAS (F5) Lightweight variants (F6) By Flight Plan Payload	Each group of reload commands includes subcommands for a allowable payload chart by using the F1–F10 keys. When the ground crew receives a command, they report: "Copy". After completing the reload, they respond: "Commander, weapons reloaded".
	(F2) Refuel	(F1) 25% (F2) 50% (F3) Maximum Combat Weight (F4) Maximum Ferry Weight	If the ground crew receives a command, they report: "Copy". After reloading is complete they respond: "Commander, HMS mounted".
	(F3) Change helmet- mounted device...	(F1) Setup HMS (F2) Setup NVG	If the ground crew receives a command, they report: "Copy". After reloading is complete they respond: "Commander, NVG mounted". If the ground crew receives a command, they report: "Copy". After reloading is complete they respond: "Commander, ground electric power connected".
	(F4) Ground electric power	(F1) On (F2) Off	If the ground crew receives a command, they report: "Copy". After reloading is complete they respond: "Commander, ground electric power disconnected". If the ground crew receives a command, they report: "Copy". After reloading is complete they respond: "Commander, Turbo gear connected".
	(F5) Select power source...	(F1) Turbo Gear (F2) Rotor Gear	If the ground crew receives a command, they report: "Copy". After reloading is complete they respond: "Commander, Turbo gear disconnected". If the ground crew receives a command, they report: "Copy". After reloading is complete they respond: "Commander, Turbo gear disconnected".

[X] - flight member

[N] - player's callsign

[M] - airfield tower or helipad callsign



## AI Messages

AI objects in the game will also send messages to the player. Wingmen will inform the player about their actions and detected threats. The Control Tower will provide information about takeoff and landing procedures.

- Sender – designates object that sends a message.
- Event – situation in which message is generated.
- Radio message – the text of message that player hears.

Report initiator	Event	Radio Report
Wingman	Takeoff	"[X], Takeoff"
Wingman	Wheels up after takeoff	"[X], wheels up"
Wingman	Illuminated by laser	"[X] Laser spike, [Y] o'clock"
Wingman	Surface-to-Air Missile fired at wingman	"[X] Sam launch, [Y] o'clock"
Wingman	Performing defensive maneuver against threat	"[X] Engaged defensive"
Wingman	Hit by enemy fire and damaged	"[X] I'm hit" or "[X] I've taken damage"
Wingman	Is ready to eject from aircraft	"[X] Ejecting" or "[X] I'm punching out"
Wingman	Wingman has spotted enemy ground target	«[X] Ground target detected, bearing [ZZZ] for [YYY]»
Wingman	Wingman has spotted high priority target (SAM, helicopter)	"[X] Request permission to attack priority target"
Wingman	Flying to attack target	"[X] Running in" or "[X] In hot"
Wingman	Bombs released	"[X] Bombs gone"
Wingman	Air-to-ground missile fired	"[X] Missile away"
Wingman	Unguided rockets fired	"[X] Rockets gone"
Wingman	Gun fired	"[X] Guns, Guns"
Wingman	Destroyed enemy ground structure, ground vehicle, or ship	"[X] Target destroyed," or "[X] Good hits"
Wingman	Visual contact on enemy aircraft	"[X] Tally bandit, [Y] o'clock"
Wingman	Shot down enemy aircraft	"[X] Splash one," or "[X] Bandit destroyed," or "[X] Good kill, good kill!"
Wingman	Returning to base due to excessive damage	"[X] R T B," or "[X] Returning to base"
Wingman	Has reached fuel state in which aircraft must return to base or risk running out of fuel	"[X] Bingo fuel"
Wingman	No remaining weapons on wingman's aircraft	"[X] Winchester"
Wingman	Enemy aircraft is behind player's aircraft.	"Lead, check six!"
Wingman	Player's aircraft is about to explode or crash	"Lead, bail out!"





ATC - Tower	If player didn't request landing up to 1 km from runway	"[N], [M], Runway (ZZZ), wind (ZZZ) degrees at (SSS) meters per second, check landing gear".
ATC - Tower	After runway or helipad is vacated by other aircraft	"[N], [M] Cleared to landing, runway (ZZZ), wind (ZZZ) degrees at (SSS) meters per second".
ATC - Tower	Player has come to a halt after landing on runway.	"[N], [M], taxi to parking area,"
ATC - Tower	Runway is occupied by other aircraft	"[N], [M], execute go-around"

[X] - flight member

[N] - player's callsign

[M] - airfield tower or helipad callsign





**9** SUPPLEMENTS

## 9 SUPPLEMENTS

### MORSE CODE ALPHABET

Morse code	Alphabet	
	Russian	Latin
•--	А а	A a
--•••	Б б	B b
•---	В в	W w
--•	Г г	G g
--••	Д д	D d
•	Е е	E e
•••--	Ж ж	V v
--•••	З з	Z z
••	И и	I i
--•--	К к	K k
•--••	Л л	L l
--	М м	M m
--•	Н н	N n
----	О о	O o
•---•	П п	P p
•--•	Р р	R r
•••	С с	S s
-	Т т	T t
••--	У у	U u
••--•	Ф ф	F f
••••	Х х	H h
-•-••	Ц ц	C c
----•	Ч ч	O o
-----	Ш ш	Ch ch

---•-	Щ щ	Q q
-•---	Ы ы	Y y
••---	Ю ю	U u
•-•-	Я я	A a
•-----	Й й	J j
-•••-	Ь ь	X x
••-••	Э э	E e

Morse code	Digits full
•-----	1
••-----	2
•••-----	3
••••-	4
•••••	5
-•••••	6
--••••	7
---•••	8
-----•	9
-----	0
Morse code	Digits brief
•-	1
••-	2
•••-	3
••••-	4
•••••	5
-••••	6
--•••	7
-•••	8
-••	9



-	0
---	---

Morse code	Punctuation marks
•-•-•-	Period
--•-•-•	Semicolon
----•••	Colon
•• •• ••	Point
••-•-••	Question mark
•-••-•	Quotes
--••-•-	Comma
-•-•-•	Left brackets
-•-•-•-	Right brackets

## ACRONYM LIST

AAA	Anti-Aircraft Artillery
AC	Alternating Current
ADF	Automatic Direction Finder
ADI	Attitude Direction Indicator
AF	Airfield
AGL	Above Ground Level
AH	Attack Helicopter
ALT	Altitude
AMMS	Advanced Moving Map System
AOA	Angle Of Attack
AP	Autopilot
AP	Armor Piercing
APU	Auxiliary Power Unit
ASL	Above Sea Level
ATC	Air Traffic Control
ATGM	Anti-Tank Guided Missile
BIT	Built In Test
BP	Battle Position
CAM	Course Aerial
CAS	Calibrated Air Speed
CDU	Central Distribution Unit
CDM	Course Doppler
CG	Center of Gravity
DC	Direct Current
DCS	Digital Combat Simulator
DH	Desired Heading
DR	Drift Angle
DST	Distance
DT	Desired Track
DTA	Desired Track Angle
EDP	Engine Dust Protectors
EEG	Electronic Engine Governor
EGT	Exhaust Gas Temperature
EO	Electro Optical
ETA	Estimated Time of Arrival
ETP	Estimated Touchdown Point
FAC	Forward Air Controller
FARP	Forward Arming and Refueling Point
FEBA	Forward Edge of Battle
FOV	Field Of View
FPL	Flight Plan
FSK	Function Select Key



GG	Gas Generator
GNSS	Global Navigation Satellite System
GS	Ground Speed
HDG	Heading
HE	High Explosive
HMS	Helmet Mounted Sight
HSI	Horizontal Situation Indicator
HUD	Heads Up Display
IAF	Initial Approach Fix
IAS	Indicated Air Speed
IDM	Inertial Doppler
IDS	Information Display System
IFF	Identify Friend or Foe
IFR	Instrument Flight Rules
IFV	Infantry Fighting Vehicle
INU	Inertial Navigation Unit
IWP	Initial Waypoint
LAT	Latitude
LLT	Linear Lead Turn
LONG	Longitude
LWR	Laser Warning Receiver
LWS	Laser Warning System
MANPADS	Man-Portable Air Defense System
ME	Mission Editor
MILS	Abbreviation for milliradian; Bomb/Gun sight settings were expressed in mils, an angular measurement; one degree was equal to 17.45 mils.
MRB	Magnetic NDB Bearing
MWL	Master Warning Light
NATO	North Atlantic Treaty Organization
NDB	Non Directional Beacon
NVG	Night Vision Goggles
OEI	One Engine Inoperative
PT	Free Turbine
PNK	Russian "ПНК". Aircraft Flight and Navigation system
PrPNK	Russian "ПрПНК". Aircraft Targeting, Flight and Navigation System
RAIM	Receiver Autonomous Integrity Monitoring
RALT	Radar Altitude
RB	Radio Bearing
RMI	Radio Magnetic Indicator
RPM	Revolutions Per Minute
ROF	Rate Of Fire
RTB	Return To Base





SAI	Stand-by Attitude Indicator
SAM	Surface-to-Air Missile
STP	Steerpoint
TAS	True Air Speed
TCA	True Track Angle
TH	True Heading
TOW	Takeoff Weight
TP	Target Point
TV	Television
TVM	Television Monitor
UHF	Ultra High Frequency
UTC	Coordinated Universal Time
VHF	Very High Frequency
VFR	Visual Flight Rules
VMU	Voice Message Unit
VNAV	Vertical Navigation
VOR	VHF Omnidirectional Range
VVI	Vertical Velocity Indicator
WCS	Weapon Control System
WPT	Waypoint
XTE	Cross Track Error

## DEVELOPERS

### EAGLE DYNAMICS

#### Management

Nick Grey	Project Director, Director of The Fighter Collection
Igor Tishin	Project Development Manager, Director of Eagle Dynamics, Russia
Andrey Chizh	Assistant Development & QA Manager, technical documentation
Matt "Wags" Wagner	Producer, technical documentation, game design
Jim "JimMack" MacKonochie	Producer

#### Programmers

Konstantin Azarov	Weapons, data bases, track system
Alexander Babichev	Administration, GUI, mission editor
Dmitry Baikov	System, multiplayer
Ilya Belov	GUI, map, input
Valery Blazhnov	GUI, lua scripts
Nikolay Brezin	GUI, mission editor
Roman Zharkov	AI, avionics
Maxim Zelensky	AC, AI AC, flight dynamics, damage model
Andrey Kovalenko	AI AC, weapons
Ilya "Dmut" Levoshevich	AI vehicles, ships, triggers, installer
Alexander Oikin	Avionics
Evgeny Pod'yachev	Plugins, build system
Alexey Smirnov	Effects, graphics
Konstantin Stepanovich	Avionics, AI AC

Oleg "Olgerd" Tischenko	Avionics
Vladimir Feofanov	AI AC flight dynamics
Sergey "Klen" Chernov	Avionics input
Alexey "Fisben" Shukailo	Avionics
Gregory Yakushev	Graphic engine, system

## Designers

Yury "SuperVasya" Bratukhin	AC, vehicles, weapons
Alexander "Skylark" Drannikov	GUI, AC
Vladimir Dimchoglo	Buildings, terrain
Maria Kakovkina	Buildings
Vlad "Stavr" Kuprin	GUI, AC
Stanislav "Acgaen" Kolesnikov	Cockpit, AC, weapons
Vladimir Trifonov	Terrain
Valery Tseiter	Buildings
Timur Tsigankov	AC, vehicles, ships, weapons

## Quality Assurance

Yury "Ulrich" Tkachev	Lead-tester
Daniel "Han" Tuseev	Lead-tester
Valery "USSR_Rik" Khomenok	Testing, tracks, localization

## Science support

Dmitry "Yo-Yo" Moskalenko	Mathematical models of dynamics, systems, ballistics
---------------------------	--

## Customer support

Alexander "Tez" Sobol	Customer support, WEB, forum
Konstantin "Const" Borovik	System and network administrator, forum
Ekaterina Perederko	System and network administrator, forum

## SUBJECT MATTER EXPERTS

Hero of Russia, Honored military pilot, Sniper pilot,  
Colonel Alexander Rudykh

Candidate of military science, Class 1 pilot (army aviation),  
Colonel Alexander Podvoisky

War veteran (Afghan war, Chechen war), Sniper pilot (army aviation),  
Lieutenant colonel Oleg Vasilenko

Pilot-instructor, reserve officer, Sergey Rudykh

Aviation engineer Tihomir "AirTito" Ivanov

## TESTER STAFF

Adam "DedCat" Philippe; Alan "HammFist" Hamm; Alan "Diveplane" Mains; Andreas "Taipan" Sigl; Anthony "Sven" Yelland; Bart "Ross" Rosselle; Bill "Rabbit" Krause; Brian "Gideon" Bowser; Brandt "BBQ" Ryan; Brian "BrianB" Brunswick; Carlos "Design" Pastor Mendez; Cato "Glowing Amraam" Bye; Christopher "Mustang" Wood; Daniel "Dredd" Judge; Dannel "TomAce" Sargent; Dave "USAFMTL" Slavens; David "Maximus" Graser; Delbert "Swartz" Swartzentruber; Derek "Prophet" Rupe; Dong "DDQ" Jian; DU HongWen "dhw725"; Edward "Ed "Manawar" Green; Enrique González "Reisen" Sánchez; Eric "Helix" Stoddard; Eugene "EvilBivol-1" Bivol; Francesc "Doppler" Basullas; FU Jian "Jeanfox"; Gabriel "Goob" DeVault; Geoff "Rastus" Brown; Geoff "Bat" Burkill; George "GGTharos" Lianeris; Guillaume "GhostriderC6" Houdayer; Guillaume "Dimebug" Leleve; Henry "Britgliderpilot" Wood; Jens "Alfa" Johansen; Leigh "Anytime" Woolley; Lionel "Eaglebow" Coherier; Marco Antonio Suárez "Mark" Peña; Mark "Shepski" Shepheard; Martin Courtney "Ice" Weare; Matthias "Groove" Techmanski; Matthew Bennett "Fudd" Shafter; MaXiaoYu "Mark291"; Michael "Caretaker" Rinner; Michael "MoGas" Stobbe; Michael "SuperKungFu" Kung; Mike "Rockwelder" Burke; Mike G "Ziggy" Reinfeld; Mu "Ur235" Lin; Nick "Crazyleggs" Chayer; Nils Gunnar "Fox" Nerland; Pascal "Cougar" Bidegare; Paul "PoleCat" Johnston; Philippe "Phil\_C6" Affergan; Peter "Weta43" McAllister; Richard A "Ironhand" Sorochak; Erich "ViperVJG73" Schwarz; Richard "Flexman\_UK" Hawley; Robert Edwin "Bob" Jidwick; Roberto Benedi "Radar Rider" García; Roberto "Vibora" Seoane Penas; Russ "44th Eagle" Kozik; Shan Jie "Shan\_Jie"; Stephen "Fragal" Handley; Tetsue "TekaTeka" Kawano; Thierry "Sparfell" Renaud; Thomas Deziderius "ThomasDWeiss" Weiss; Tim "Drone" McGinty; Todd "44th\_Veldcath" Hartman; William "D-Scythe" Ngai; Alexnder "Alders" Boganchenko; Iexey "USSR\_Baikal" Luzin; Andrey "depilot" Ponomarenko; Valery "=FV=BlackDragon" Manasyan; Valdemar "BETEP" Krug; Vitaly "Kemper" Silaev; Vladislav "Vadifon" Uli'anitskiy; Dmitry "Laiwynas" Koshelev; Dmitriy "Condor11" Stepanchuk; Ivan "ФрогФут" Makarov; Mikhail "Scart" Burmakin; Semen "=FV=MAD" Zimin; Sergey "Triff" Gumilevsky; Sergey "butcher" Sidorov; Stanislav "Biolog" Burlakov.

## THIRD PARTIES

Andrey "ZloySkin" Suvorkin – 9M39 Igla; 9M333 Strela-10; MIM-115 Roland; M26 rocket; M48 Chaparral; 9M33 Osa; 9M330 Tor; S-13 rocket; MIM-23B; 9M31 Strela-1; 9M55K Smerch; M1126 Stryker ICV; FIM-92 Stinger; 9M311 Tunguska; 9M38 Buk; 3M9 Kub; 9M22U Grad; 9M117 Basnya; BGM-71D Tow; Kh-59M; MIM-104; M1134 Stryker ATGM; M6 Linebacker; 9K35M3 Strela-10SV; M163 Vulcan; M1128 Stryker MGS; M2 Bredley; LAV-25; AIM-120C; AIM-120B; MLRS; MTLB; M1A2; Hydra Rocket; SA-18; Stinger; M1025 HMMWV; M1045 TOW HMMWV; M973 Avenger; BRDM-2; Strela-1; Ka-27PL; UH-60A; OH-58D.

Denis "Golif26" Yakovenko – BTR-80; BMP-1; BMD-1; BTR-RD; BMP-2; BMP-3; T-80U; 2S1 Gvozdica; 2S3 Akatsia; 2S9 Nona; 2S19 Msta; 9A33BM2 Osa-AKM; 2K22M Tunguska.

Konstantin "Bauris" Kim – UAZ-469; Leclerc; Leopard 2A5; MCV-80; Leopard-1A3; M-109A6; Marder-1A3; Gepard.

Evgeny "GK" Khizhnyak – T-72B; T-55; KAMAZ-43101; M978 HEMTT Tanker; SA-3; P-37 Radar; PRV-11 radar; P-19 radar; RSP-7 approach system.

Valery "Valery" Mag'ky, Georgy "Gys71" Sinitso – Sea Eagle; ALARM; Tornado GR3; Tornado IDS.

Dmitry Sayapin – CH-47D.

Piter Pan – MQ-1 Predator; RQ-1P GCS (Ground Control Station), RQ-1U Trojan SPIRIT II SATCOM link.

Mark Mardot – Kormorant.

MigMac – AIM-54C.

Redline – HAP C-8.

MBot – AIM-9P.

Eric "EricJ" Johnson – Ka-50, CH-47 textures.

Anton "Flanker" Golubenko – Ka-50, Mi-24V, UH-60A textures.

Dmitry "Laivynas" Koshelev – Ka-50 textures.

Alan "Diveplane" Mains – Ka-50 textures, effect sounds.

Mike "Rocky" Burke – terrain textures, airdrome scenerys.

Steffen "GrandSurf" May – terrain textures, airdrome scenerys.

Christina "Mizzy" Dearnley – Ka-27, Ka-50, UH-60A, AH-64 textures.

Murat "Yeniceri" ISIKCI – CH-47 and building textures.

Dmitry "d\_dimon" Dobrygin – Challenger 2.

## SPECIAL THANKS

Eugene "EvilBivol-1" Bivol for community support and translations  
Dmitry "Condor11" Stepanchuk for translations  
Dmitry "Laivynas" Koshelev for developer helps and community support  
Cato "Glowing Amraam" Bye for excellent video footages  
Chris "BeachAV8R" Frishmuth for publications  
Tetsue "TekaTeka" Kawano for mods  
Richard A "Ironhand" Sorochak for tracks support  
Zhdanov A. for ABRIS documentation  
Vladislav "Vadifon" Ul'yanitskiy for draws for manual  
Andrey Zinchuk for photos  
Igor Minin for S-8, S-13 rocket data  
Vitaly "Coyote" Kucherenko for 3-rd parties' coordination and articles for encyclopedia  
Boris "Orthodox" Tsibin for radio files recording  
Arthur "Packman" Yasukevich for ATC voice casting  
Cristina "=RAF=StellaMala" Surina for sounds  
"-=RFF=- Hrisa" for sounds  
Oleg "=FV=Vultur" Mizgirev for sounds  
Marat "Aim" Zeinetdinov for sounds  
Arcady "Arkady" Zakharov for sounds  
Sergey "butcher" Sidorov with Alexander "Aktasar" Varshalomidze support for sounds  
Andrey "Cikory" Emel'yanov with Vladimir Pivnev support for sounds  
Vladislav "Dobryj" Begunov for sounds  
Valery "=FV=BlackDragon" Manasyan for sounds  
Andrey "Dronas" Kytin for sounds  
Vladislav "FreeHunter" Kurnosov for sounds  
Sergey "Lemon Lime" Chernov for sounds  
Maxim "maksimbendv" Bendov for sounds  
Andrius "Peyoteros" Vaitkevicius for sounds  
Valery "PallMall" Myagky for sounds

Vitaly "Vitalka" Shpakovsky for sounds  
Antanas "Woox" Daujotis for sounds  
Polina Moskalenko for sounds  
Brandt "BBQ" Ryan for documentation and mission editing  
Kevin MacLeod for music for GUI  
"Put' na dvoikh" for songs (radio Mayak)  
"Bliznetsy Bu" for funk (radio Mayak)  
"Original Fake" for rock-n-roll (radio Mayak)

## TRANSLATOR TEAMS

### French Team:

Maxime "Hellflyer" Albert  
Vincent "Booz" Audibert  
Clément "Azrayen" Bakes  
Joël "3rd\_tontonjoe" Bourgault  
Laurent "VEAF\_Buzz" Buzzi  
Pierre-Alain "T3" Carton  
Frédéric "VEAF\_Couby" Coubard  
Alain "Dick" Dicrescenzo  
Olivier "Moos" Doveil  
Clément "Moutton" Ducasse  
Julien "121st\_Psycho" Gras  
Valéry "VEAF\_Toopack" Hugueville  
Marc "VEAF\_Marge" Landreaud  
Xavier "Mitor" Milliet  
Yann "VEAF\_Darthmoul" Moullenc  
Guillaume "VEAF\_Berkout" Ring  
Dimitri "Diditopgun" Routier

### German Team:

Matthias "Groove" Techmanski

Erich "ViperVJG73" Schwarz  
Jens "Vinc\_Vega" Muehlstaeff  
Andreas "URZE" Urzedowski  
Raik "Wolke10" Kolmorgen  
Stephan "Acedy" Makulla

### **Spanish Team:**

Roberto "Vibora" Seoane Penas  
Carlos "Design" Pastor Méndez  
Francesc "Doppler" Basullas Navarro  
Roberto "Radar Rider" Benedí García  
Marco Antonio "Mark" Suárez Peña  
Miquel "Mikeloto" Ferrera Pizarro



## BIBLIOGRAPHY AND SOURCES

- Air Fleet - Russian Air Force, Aircraft & Space Review magazine
- World Air Power journal. Aerospace Publishing Ltd.
- US Army Aviation Logistics School: HELICOPTER FUNDAMENTALS
- Army Field Manual FM 1-203, Fundamentals Of Flight
- Jane's. Paul Jackson. All the World's Aircraft. Eighty-seven year of issue 1996-97.
- V.Mikheyev. "Mil Moscov Helicopter Plant 50 Years". 1998.
- Мазепов А., Михеев С., Зенкин В., Жирнов А., Ка-50 Армейский боевой вертолет. POLYGON. Авиационная серия. – М.: «Любимая книга», 1996.
- Михеев С. Боевые вертолеты фирмы КАМОВ. Состояние и перспективы развития. – Вестник Московского Авиационного Института. 2000.
- Петросян Э. Особенности аэродинамики вертолета сосной схемы. – Вертолет. 2002. №3.
- Ганюшкин Ю. Приоритет за ОКБ Камова. – Вертолет. 2003. №3.
- Кузнецов Г. Летчику на заметку. – Вертолет. 2005. №2.
- Ковалев В. Устройство вертолета.
- Дмитриев В., Вожаев Е., Каргопольцев Е., Приоритетные направления повышения конкурентоспособности вертолетной техники. – ЦАГИ. 2002.
- Гессоу А., Мейерс Г. Аэродинамика вертолета. Перевод Бирюлина В. Под редакцией Братухина И. – М.: Государственное издательство оборонной промышленности. 1954.
- Загордан А. Элементарная теория вертолета. – М.: Военное Издательство Министерства Обороны Союза ССР. 1955.
- <http://www.kamov.ru>
- <http://www.dynamicflight.com>
- <http://www.aviastar.org>
- <http://pvo.guns.ru>
- <http://www.fas.org>